

# Carbon Capture, Utilization and Storage (CCUS)

Policy Framework and its  
Deployment Mechanism in India

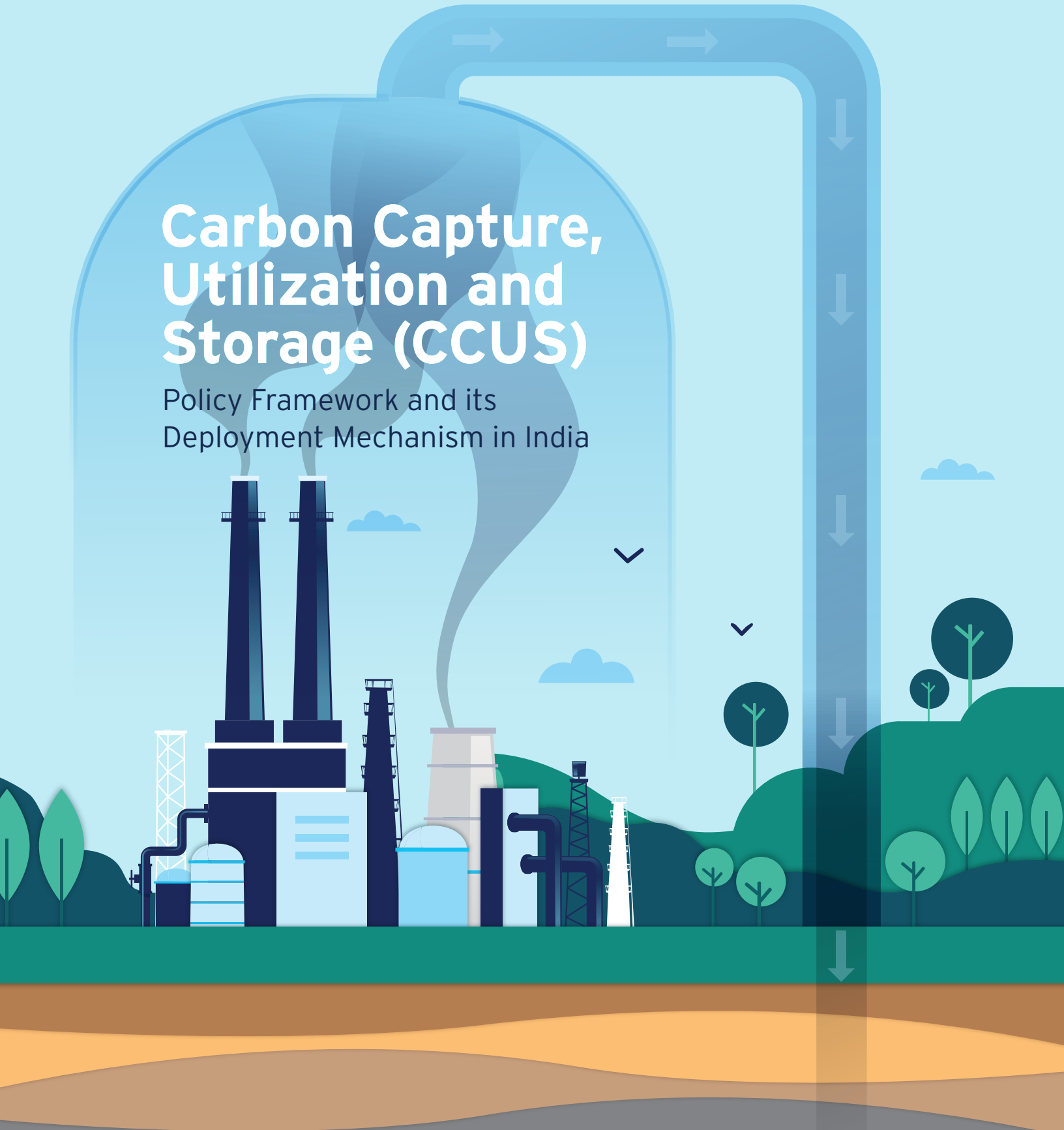



# Authors and Acknowledgements

## Authors

**Atanu Mukherjee**, Principal Investigator,  
M. N. Dastur & Co. (P) Ltd.

**Saurav Chatterjee**, Co-Principal Investigator,  
M. N. Dastur & Co. (P) Ltd.

## Leadership

The team is grateful for the mentorship and inputs provided by:

**Dr. V. K. Saraswat**, Member, NITI Aayog

**Dr. Neeraj Sinha**, Sr. Adviser (S&T), NITI Aayog

**Shri Rajnath Ram**, Adviser (Energy), NITI Aayog

## Acknowledgment

The study was carried out with the financial support of NITI Aayog, Government of India and conducted by M. N. Dastur & Co. (P) Ltd. The team is grateful for the input and contributions received from:

**Shri Jawahar Lal**, Deputy Chief Engineer, NITI Aayog

**Shri Naveen Kumar Vidyarthi**, Director (Energy), NITI Aayog

**Shri Amit Verma**, Director (Energy), NITI Aayog

**Shri Manoj Kumar Upadhayay**,  
Deputy Advisor (Energy), NITI Aayog

**Dr. Abhinav Trivedi**, Consultant, NITI Aayog

**Shri Akash Jain**, Young Professional, NITI Aayog

**Abhijit Sarkar**, Vice President, Dastur International, Inc.

**Dr. Suprotim Ganguly**, Techno-Strategic Advisor,  
M. N. Dastur & Co. (P) Ltd.

**Arunava Maity**, Sr. Principal Analyst, M. N. Dastur & Co. (P) Ltd.

**Dr. Vikram Vishal**, Convenor - National Centre of Excellence in  
Carbon Capture and Utilization, IIT Bombay

**Dr. Ken Medlock**, Baker Institute, Rice University

**Phil Amick**, Principal, Dastur Energy Inc.

**Dr. Susan D. Hovorka**, The University of Texas at Austin

**Saptarshi Bhattacharya**, M. N. Dastur & Co. (P) Ltd.

**Anand Senguttuvan**, M. N. Dastur & Co. (P) Ltd.

**Arnab Adak**, M. N. Dastur & Co. (P) Ltd.

**Debarka Chakraborty**, M. N. Dastur & Co. (P) Ltd.

**Anindya Majumdar**, M. N. Dastur & Co. (P) Ltd.

**Pratyush Kumar**, M. N. Dastur & Co. (P) Ltd.

## Acknowledgment

We would also like to thank the following organizations who provided valuable inputs in shaping the report:

**Shri A. Balan**, Member (Planning),  
Central Electricity Authority, India

**Shri A K Rajput**, Chief Engineer, Central Electricity Authority, India

**Shri Neelesh Kr Sah**, Joint Secretary,  
Ministry of Environment, Forest and Climate Change, Govt. of India

**Shri Gurdip Singh**, Chairman and Managing Director,  
National Thermal Power Corporation Ltd.

**Shri Nalin Singhal**, Chairman and Managing Director,  
Bharat Heavy Electricals Ltd.

**Shri U K Bhattacharya**, Director,  
National Thermal Power Corporation Ltd.

**Shri Anirban Das Gupta**, Director-in-Charge,  
Steel Authority of India Ltd.

**Shri Sanjay Shrivastava**, Executive Director -  
Chief Carbon Management & Sustainability Group,  
Oil and Natural Gas Corporation Ltd.

**Shri Peeyush Kumar**, Officer on Special Duty,  
Ministry of Coal, Govt. of India

**Dr. Anita Gupta**, Adviser / Scientist G,  
Department of Science & Technology

**Shri Sanjay Singh**, Scientist G, Technology Information  
Forecasting and Assessment Council

**Dr. Deepak Saxena**, Executive Director, Indian Oil Corporation Ltd.

**Shri Pradeep**, Executive Director, Technology Information  
Forecasting and Assessment Council

**Shri Gaurav Mishra**, Executive Engineer,  
Reservoir, Oil and Natural Gas Corporation Ltd.

**Shri Sujit Mitra**, General Manager - Reservoir,  
Oil and Natural Gas Corporation Ltd.

**Smt. Neha Verma**, Director, Ministry of Steel, Govt. of India

**Shri Paramjeet Singh**, Additional Industrial Advisor,  
Ministry of Steel, Govt. of India

**Dr. Mukesh Kumar**, Director - Steel Research & Technology  
Mission of India, Ministry of Steel, Govt. of India

**Shri Kumar Saurabh**, Deputy Director,  
Ministry of Power, Govt. of India

**Ms. Soujanya Mondal**, Senior Manager, Corporate Strategy,  
Planning & Advocacy, Gas Authority of India Ltd.

**Shri Rahul Buswala**, Strategy Manager,  
Carbon Capture, Bharat Heavy Electricals Ltd.

### Available at:

NITI Aayog: [www.niti.gov.in](http://www.niti.gov.in)

### Disclaimer

M. N. Dastur & Co. (P) Ltd. has received the financial assistance under the Research Scheme of NITI Aayog to prepare the report. While due care has been exercised to prepare the report using the data from various sources, NITI Aayog does not confirm the authenticity of data and the accuracy of the methodology to prepare the report. NITI Aayog shall not be held responsible for finding or opinions expressed in the document. This responsibility completely rests with M. N. Dastur & Co. (P) Ltd.

# About DASTUR



---

M. N. Dastur & Company (P) Ltd. along with Dastur Energy (DASTUR) conceptualizes, designs, and develops business, technology, engineering and policy blueprints for clean energy systems for enterprises, governments, and institutions. DASTUR envisions the enablement of an affordable and clean energy future through industrial decarbonization, carbon capture, low-carbon alternative fuels and low-carbon transformation of solid fuels and hydrocarbons. DASTUR has conceptualized and designed several pioneering industrial-scale low-carbon projects worldwide in hydrogen, methanol, chemicals, steel, hydrocarbons, power, and carbon capture, and works with governments and international institutions on policy and market design aspects for enabling a low-carbon economy. DASTUR's intellectual property and operating frameworks help design commercially viable and sustainable energy solutions using low-carbon energy technologies and carbon capture utilization and storage. DASTUR optimizes the design of integrated clean energy systems for superior long-term techno-economic performance that include emerging energy systems like industrial carbon capture systems, CO<sub>2</sub> utilization and sequestration, clean baseload power, clean hydrogen production, net-negative gasifier complexes, methanol ecosystems, waste gas conditioning and use, clean chemicals, and clean materials. DASTUR's intellectual assets in clean energy systems, economics, and finance help shape policies and strategies in clean energy market designs, carbon capture, carbon credit & trade mechanisms, regulatory frameworks, and macro-energy strategies for nations and institutions. By designing scalable clean energy systems which are pragmatic, commercially viable, and competitive, DASTUR makes sustainability and climate goals real, achievable, and implementable.

# Contents

<b>Executive Summary</b>	15
-----	
<b>1. Introduction</b>	27
-----	
<b>2. Analysis of Sector-wise CO<sub>2</sub> Emissions</b>	35
-----	
<b>3. Overview of CO<sub>2</sub> Capture &amp; Utilization Technologies</b>	67
-----	
<b>4. Potential for CO<sub>2</sub> Storage in India</b>	93
-----	
<b>5. CCUS Policy Framework for India</b>	111
-----	
<b>6. Investment and Financing Mechanism</b>	135
-----	
<b>7. Conclusions</b>	157
-----	
<b>Bibliography</b>	163
-----	

# List of Figures

<b>Figure E-1</b>	The 70% Emissions Challenge	<b>Figure 2-19</b>	Top 10 Cement Clusters Based on Cumulative Capacity
<b>Figure E-2</b>	Sector-wise CO <sub>2</sub> Emissions (in mtpa)	<b>Figure 2-20</b>	Cement Demand (in mtpa) and Per-capita Cement Consumption (in kg)
<b>Figure E-3</b>	Cost Curve for CO <sub>2</sub> Capture Across Industries/Sectors	<b>Figure 2-21</b>	Typical Process Flow Diagram for Cement Making
<b>Figure E-4</b>	Mega Scale CO <sub>2</sub> Cluster Model	<b>Figure 2-22</b>	Typical CO <sub>2</sub> Cascade (in kg of CO <sub>2</sub> per tonne of cement)
<b>Figure E-5</b>	Region-wise Storage Clusters in India	<b>Figure 2-23</b>	Cement Plant CO <sub>2</sub> Emission Projection (in mtpa)
<b>Figure 1.1</b>	The 70% Emissions Challenge	<b>Figure 2-24</b>	Simplified Block Flow Diagram of Hydrogen Generation Units (HGUs)
<b>Figure 2-1</b>	Illustration of Emission Types and Boundary Consideration	<b>Figure 2-25</b>	Domestic Oil Production (in mtpa)
<b>Figure 2-2</b>	Sector-wise CO <sub>2</sub> Emissions, mtpa	<b>Figure 2-26</b>	Natural Gas Production - FY 2014-15 to FY 2019-20 (in billion cubic meter)
<b>Figure 2-3</b>	Break-up of Installed Generation Capacity, GW	<b>Figure 2-27</b>	Oil Production by Operator in FY 2019-20 (in mtpa)
<b>Figure 2-4</b>	Break-up of Generation, Billion Unit	<b>Figure 2-28</b>	Natural Gas Production in FY 2019-20 (in billion cubic meters)
<b>Figure 2-5</b>	Break-up of Thermal Power Plants by Fuel (Power Sector at a Glance ALL INDIA)	<b>Figure 2-29</b>	Carbon Emission by E&P Operator in FY 2019-20 (in mtpa of CO <sub>2</sub> eq)
<b>Figure 2-6</b>	PFD of Coal-fired TPP	<b>Figure 2-30</b>	Emissions Projection for 2030, MT CO <sub>2</sub> eq
<b>Figure 2-7</b>	Schematic Representation of Gas Turbine	<b>Figure 2-31</b>	A Typical Coal Gasification Based Ecosystem
<b>Figure 2-8</b>	NGCC Power Plant Schematic Diagram	<b>Figure 3-1</b>	Scheme of Post-combustion, Pre-combustion & Oxy-fuel combustion
<b>Figure 2-9</b>	Share of Total CO <sub>2</sub> Emissions by Each Prime Mover, mtpa	<b>Figure 3-2</b>	Simplified Representation of CO <sub>2</sub> Capture Technologies
<b>Figure 2-10</b>	State-Wise Analysis of CO <sub>2</sub> Emissions (mtpa)	<b>Figure 3-3</b>	Schematic Representation of Working Principle of Solvent-Based CO <sub>2</sub> Capture
<b>Figure 2-11</b>	Crude Steel Capacity & Production in Last 5 Years (in mtpa)	<b>Figure 3-4</b>	Schematic Representation of CO <sub>2</sub> Absorption Capacity of Chemical and Physical Solvents as a Function of the Partial Pressure of CO <sub>2</sub>
<b>Figure 2-12</b>	Process Route Wise Steel Production and Contribution (in mtpa)	<b>Figure 3-5</b>	Operating Regimes of Various Solvents for CO <sub>2</sub> Capture
<b>Figure 2-13</b>	Various Iron and Steel Making Routes in India	<b>Figure 3-6</b>	Typical Flow Diagram of a Chemical Solvent Based CO <sub>2</sub> Capture
<b>Figure 2-14</b>	CO <sub>2</sub> Emission (in tonne) per tonne of Finished Steel BF-BF route		
<b>Figure 2-15</b>	Region-wise Distribution and Total CO <sub>2</sub> Emissions (in mtpa)		
<b>Figure 2-16</b>	Cement Production (in mtpa)		
<b>Figure 2-17</b>	Per Capita Cement Consumption in 2018 (in kg)		
<b>Figure 2-18</b>	Cement Production (in mtpa)		

<b>Figure 3-7</b>	Process Flow Diagram of Air Liquide's Amine Based CO <sub>2</sub> Capture	<b>Figure 3-23</b>	Promising CO <sub>2</sub> Utilization Technology Propositions
<b>Figure 3-8</b>	Process Flow Diagram of a Pilot Slipstream Test Unit at National Carbon Capture Center, USA using ION's Proprietary ICE-21 Solvent for CO <sub>2</sub> Capture	<b>Figure 4-1</b>	Working of CO <sub>2</sub> EOR
<b>Figure 3-9</b>	Process Flow Diagram of KM CDR CO <sub>2</sub> Capture using Proprietary KS-1 Solvent	<b>Figure 4-2</b>	Working of CO <sub>2</sub> ECBMR
<b>Figure 3-10</b>	Process Flow Diagram of the Amine Guard™ FS CO <sub>2</sub> Capture using Proprietary UCARSOL™ Solvent	<b>Figure 4-3</b>	Classification of CO <sub>2</sub> Storage Potential of Sedimentary Basins of India
<b>Figure 3-11</b>	Process Flow Diagram of Baker Hughes Chilled Ammonia Process (CAP) using Ammonium Carbonate Solvent	<b>Figure 4-4</b>	Major Sedimentary Basins in India with their CO <sub>2</sub> Storage Potential
<b>Figure 3-12</b>	Basic Process Flow diagram of the Rectisol® Process	<b>Figure 4-5</b>	Seven RSCPs Funded by the US DOE
<b>Figure 3-13</b>	Basic Process Flow Diagram of the Selexol™ Process	<b>Figure 5-1</b>	CCUS Hub and Cluster Framework
<b>Figure 3-14</b>	Basic Process Flow Diagram of Air Products' VSA Technology	<b>Figure 5-2</b>	CCUS Cluster Around the World
<b>Figure 3-15</b>	Five-step Pressure-swing Cycle of UOP's Polybed™ PSA Systems	<b>Figure 5-3</b>	Rotterdam CCS Cluster
<b>Figure 3-16</b>	Process Flow Diagram of the Cryocap™ H <sub>2</sub> Technology	<b>Figure 5-4</b>	Timeline Denver City Hub
<b>Figure 3-17</b>	Summary of Major Large Scale Carbon Capture Commercial Projects	<b>Figure 5-5</b>	Denver City Storage
<b>Figure 3-18</b>	Cost Curve for CO <sub>2</sub> Capture Across Processes/Industries	<b>Figure 5-6</b>	ACTL Map
<b>Figure 3-19</b>	Possible CO <sub>2</sub> Utilization Pathways	<b>Figure 5-7</b>	ACTL Timelines
<b>Figure 3-20</b>	A Simplified Schematic of CO <sub>2</sub> Mineralization Process	<b>Figure 5-8</b>	Mega Scale CO <sub>2</sub> Cluster Model
<b>Figure 3-21</b>	Typical Schematic for the CO <sub>2</sub> Hydrogenation Process along with Integration with Carbon Capture Unit	<b>Figure 5-9</b>	Region-wise Storage Clusters in India
<b>Figure 3-22</b>	Systematic Indigenization of Technology through Technology Transfer	<b>Figure 6-1</b>	Utility Costs Considered
		<b>Figure 6-2</b>	Sector-wise CO <sub>2</sub> emission and Contribution
		<b>Figure 6-3</b>	Incentives such as the Product Linked Incentive (PLI) scheme create a level playing field for low-carbon products
		<b>Figure 6-4</b>	CCUS Financing Mechanism
		<b>Figure 6-5</b>	Results of CCUS Financing Analysis - Financing Option 1 (Clean Energy Cess)
		<b>Figure 6-5</b>	Results of CCUS Financing Analysis - Financing Option 2 (Bonds and Govt. Budget Support)
		<b>Figure 6-6</b>	SPV Framework to Finance Gasification Projects in a Deficit-Neutral Way

# List of Tables

<b>Table E-1</b>	Estimated CO <sub>2</sub> Storage Capacity in India	<b>Table 3-2</b>	Comparative Analysis of Various Classes of CO <sub>2</sub> Capture Technologies
<b>Table E-2</b>	Sector-wise Typical Carbon Capture Capital Charge and Cash Cost	<b>Table 3-3</b>	Various CO <sub>2</sub> Utilization Pathways
<b>Table E-3</b>	CCUS Funding through Clean Energy Cess	<b>Table 4-1</b>	CO <sub>2</sub> EOR Storage Capacity Estimates
<b>Table E-4</b>	CCUS Funding with Bonds and Government Budgetary Support	<b>Table 4-2</b>	CO <sub>2</sub> ECBMR Storage Capacity Estimates
<b>Table 1-1</b>	Large Scale CCUS facilities in operation in 2020	<b>Table 4-3</b>	CO <sub>2</sub> Storage Capacity Estimation for Deep Saline Aquifers
<b>Table 2-1</b>	Flue Gas Characteristics of Coal-Fired Thermal Power Plants	<b>Table 4-4</b>	Basalt Formation CO <sub>2</sub> Storage Capacity Estimates
<b>Table 2-2</b>	Flue Gas Characteristics of Coal-Fired Thermal Power Plants	<b>Table 4-5</b>	Theoretical CO <sub>2</sub> Storage Capacity in India
<b>Table 2-3</b>	Overall Analysis of CO <sub>2</sub> Emissions from the Power Sector in India	<b>Table 5-1</b>	EU Funding Schemes for CCUS
<b>Table 2-4</b>	CO <sub>2</sub> Emissions by Prime Mover for Plants with Minimum 2 mtpa Capturable CO <sub>2</sub>	<b>Table 5-2</b>	Carbon Pricing System Adopted by Different Provinces of Canada
<b>Table 2-5</b>	District-wise CO <sub>2</sub> Emission Analysis	<b>Table 5-3</b>	Comparison of Carbon Credits/Incentives and Carbon Tax Based Policy
<b>Table 2-6</b>	Energy & CO <sub>2</sub> Volume Projections for FY 2029-30	<b>Table 5-4</b>	Key Elements of a CCUS Policy Framework for India
<b>Table 2-7</b>	CO <sub>2</sub> Direct Emission Intensities for Various Iron Making Routes	<b>Table 5-5</b>	Sedimentary Basins Spanning Across Multiple Regions
<b>Table 2-8</b>	Major Players of Cement Industry and Capacity in mtpa)	<b>Table 6-1</b>	Capex and Opex Considerations for CCUS Retrofit
<b>Table 2-9</b>	State-wise Cement Capacity	<b>Table 6-2</b>	Sector-wise Typical Carbon Capture Capital Cost
<b>Table 2-10</b>	Top 20 Districts/Clusters and Aggregate Capacity	<b>Table 6-3</b>	Sector-wise Typical Carbon Capture Cash Costs
<b>Table 2-11</b>	Plant Capacity Distribution	<b>Table 6-4</b>	Sector-wise Typical Carbon Capture Cash Costs and Capital Charges
<b>Table 2-12</b>	Consumption Parameters	<b>Table 6-5</b>	Carbon Capture Volume in Two Scenarios and Tentative Investment
<b>Table 2-13</b>	Gas Composition at Different Source Points	<b>Table 6-6</b>	Assumptions/Considerations for CCUS Financing Analysis
<b>Table 2-14</b>	CO <sub>2</sub> Concentration at Different Refinery Units	<b>Table 6-7</b>	45Q Tax Credit Amounts
<b>Table 2-15</b>	Cracker Furnace Flue Gas Composition	<b>Table 6-8</b>	Tax Credits for Hydrogen Production in USA - Inflation Reduction Act of 2022
<b>Table 2-16</b>	Total CO <sub>2</sub> Emissions from Refineries, Petrochemicals & Fertilizers	<b>Table 6-9</b>	Probable Distribution of 750 mtpa and low-C Product Volume
<b>Table 2-17</b>	Total CO <sub>2</sub> Emissions from Oil & Gas Upstream Operations	<b>Table 7-1</b>	Sector-wise CO <sub>2</sub> Emissions and Interventions Required
<b>Table 2-18</b>	Total CO <sub>2</sub> Emission from Coal Gasification	<b>Table 7-2</b>	Theoretical CO <sub>2</sub> Storage Capacity in India
<b>Table 2-19</b>	Sector-wise CO <sub>2</sub> Emissions and Interventions Required	<b>Table 7-3</b>	Key Elements of a CCUS Policy Framework for India
<b>Table 3-1</b>	Comparison of Various Flow Schemes of UOP Amine Guard™ FS Technology	<b>Table 7-4</b>	Sector-wise Typical Carbon Capture Capital Charge and Cash Cost



# Abbreviations

**ACTL** Alberta Carbon Dioxide Trunk Line

**AD** Accelerated Depreciation

**ADB** Asian Development Bank

**ARRA** American Recovery and Reinvestment Act

**BEE** Bureau of Energy Efficiency

**BF** Blast Furnace

**BGS** British Geological Society

**BOF** Basic Oxygen Furnace

**BOO** Build-Own-Operate

**CAP** Chilled Ammonia Process

**CBAM** Cross Border Adjustment Mechanism

**CBM** Coal Bed Methane

**CCF** Climate Change Fund

**CCFC** Carbon Capture Finance Corporation

**CCL** Central Coalfields Limited

**CCM** Carbon Concentrating Mechanism

**CCUS** Carbon Capture Utilization and Storage

**CDU** Crude Distillation Unit

**FCC** Fluid Catalytic Cracking

**CEA** Central Electricity Authority

**CEIL** Cairn Energy India Limited

**CFD** Contracts-for-Difference

**CGP** Co-Gen Plant

**CIF** CCUS Infrastructure Fund

**CIFIA** Infrastructure Finance and Innovation Act

**CIL** Coal India Limited

**CIR** Color Infrared

**CO** Carbon Monoxide

**Coal DR** Coal Based DR Processes

**COG** Coke Oven Gas

**CRF** Capital recovery factor

**CRI** Carbon Recycling International

**DAC** Direct Air Capture

**DEPG** Dimethyl Ether of Polyethylene Glycols

**DGH** Directorate General of Hydrocarbons

**DOE** Department of Energy

**DRCF** Dual Refrigerant CO<sub>2</sub> Fractionation

**DVP** Deccan Volcanic Province

**E&P** Exploration and production activities

**EAF** Electric Arc Furnace

**EBP** Ethanol Blend Petrol

**ECBMR** Enhanced Coal Bed Methane Recovery

**ECL** Eastern Coalfields Limited

**EIB** European Investment Bank

**EMIT** Electromagnetic Induction Tomography

**EOR** Enhanced Oil Recovery

<b>EPA</b>	Environmental Protection Agency	<b>IFC</b>	International Finance Corporation
<b>ERT</b>	Electrical Resistance Tomography	<b>ION</b>	ION Clean Energy
<b>ESP</b>	Electrostatic Precipitator	<b>IP</b>	Intellectual Property
<b>EU ETS</b>	European Union Emissions Trading System	<b>IPCC</b>	Intergovernmental Panel on Climate Change
<b>EXIM</b>	Export Import Bank of the United States	<b>JTF</b>	Just Transition Fund
<b>FCC</b>	Fluid Catalytic Cracking	<b>JTM</b>	Just Transition Mechanism
<b>FECM</b>	Fossil Energy and Carbon Management	<b>KM CDR™</b>	Kansai Mitsubishi Carbon Dioxide Recovery
<b>FT</b>	Fischer-Tropsch	<b>LCA</b>	Life Cycle Analysis / Life Cycle Assessment
<b>FTE</b>	Full Time Equivalent	<b>LCFS</b>	Low Carbon Fuel Standard
<b>Gas DR</b>	Gas Based DR Processes	<b>LETS</b>	Low Emission Technology Statement
<b>GBI</b>	Generation Based Incentives	<b>LIC</b>	Life Insurance Corporation
<b>GBS</b>	Gross Budgetary Support	<b>LP</b>	Low-Pressure
<b>GFANZ</b>	Glasgow Financial Alliance for Net Zero	<b>MDEA</b>	Methyl diethanolamine
<b>GGPPA</b>	Greenhouse Gas Pollution Pricing Act	<b>MHI</b>	Mitsubishi Heavy Industries Ltd
<b>GT</b>	Giga Tonne	<b>MRV</b>	Monitoring Reporting and Verification framework
<b>GTPA</b>	Gigatonne Per Annum	<b>MTPA</b>	Million Tonne Per Annum
<b>HGU</b>	Hydrogen Generation Unit	<b>MVA</b>	Monitoring Verification and Accounting
<b>HP</b>	High Pressure	<b>NAS</b>	Non Aqueous Solvent
<b>IEA</b>	International Energy Agency	<b>NCEEF</b>	National Clean Energy and Environment Fund
<b>IECM</b>	Integrated Environmental Control Model	<b>NETL</b>	National Energy Technology Laboratory
<b>IETF</b>	Industrial Energy Transformation Initiative	<b>NEXI</b>	Nippon Export and Investment Insurance
<b>IF</b>	Induction Furnace	<b>NGCC</b>	Natural Gas Combined Cycle

<b>OBPS</b>	Output Based Pricing System	<b>SSEB</b>	Southern States Energy Board
<b>OPC</b>	Ordinary Portland Cement	<b>syngas</b>	Synthesis Gas
<b>OPGC</b>	Odisha Power Generation Corporation Limited	<b>T&amp;S</b>	Transport and Storage
<b>OPGGSA</b>	Offshore Petroleum and Greenhouse Gas Storage Act 2006	<b>TCF</b>	Trillion Cubic Feet
<b>PLI</b>	Production Linked Incentive	<b>TIER</b>	Technology Innovation and Emissions Reduction
<b>PMAY</b>	Pradhan Mantri Awas Yojana	<b>TIFAC</b>	Technology Information Forecasting and Assessment Council
<b>PP</b>	Power Plant	<b>TSA</b>	Temperature Swing Adsorption
<b>PPC</b>	Portland Pozzolana Cement	<b>UIC</b>	Underground Injection Control
<b>PSA</b>	Pressure Swing Adsorption	<b>UKRI</b>	UK Research and Innovation's
<b>PSC</b>	Portland Slag Cement	<b>URR</b>	Ultimate Recoverable Reserves
<b>RCF</b>	Rashtriya Chemicals & Fertilizers	<b>USIDFC</b>	US International Development Finance Corporation
<b>RCP</b>	Rotterdam Cluster Project	<b>VDU</b>	Vacuum Distillation Unit
<b>RCSPs</b>	Regional Carbon Sequestration Partnerships	<b>VGas</b>	Volume of Methane
<b>RRF</b>	Recovery and Resilience Facility	<b>VRM</b>	Vertical Roller Mill
<b>SAR</b>	Synthetic Aperture Radar	<b>VSA</b>	Vacuum Swing Adsorption
<b>SECARB</b>	Southeast Regional Carbon Sequestration Program	<b>VSP</b>	Vertical Seismic Profile
<b>SECL</b>	South-Eastern Coalfields Limited	<b>WCL</b>	Western Coalfields Limited
<b>SMR</b>	Steam Methane Reforming		

सुमन के. बेरी

उपाध्यक्ष

**SUMAN K. BERY**

VICE CHAIRMAN

Phones : 23096677, 23096688

Fax : 23096699

E-mail : vch-niti@gov.in



सत्यमेव जयते



भारत सरकार  
नीति आयोग, संसद मार्ग  
नई दिल्ली - 110 001

Government of India  
NATIONAL INSTITUTION FOR TRANSFORMING INDIA  
NITI Aayog, Parliament Street,  
New Delhi - 110 001

## MESSAGE

India is making a decisive march towards a sustainable energy future. Prime Minister Narendra Modi's pledge at COP26 towards a net-zero India by 2070 promises to accelerate this momentum. Extensive measures are needed to deliver on these promises.

India's per capita CO<sub>2</sub> emissions are about 1.9 tonnes per annum, which is less than 40% of the global average and about one-fourth of that of China. We need a sustainable solution for the decarbonisation of sectors that contribute to 70% of emission. Carbon Capture Utilisation and Storage (CCUS) has an important and critical role to play in it, especially for India to accomplish net-zero by 2070.

To further complement these ongoing efforts, India is prioritizing Carbon Capture, Utilisations and Storage as a potential solution to decarbonise hard-to abate sectors such as Thermal Power Plant, Iron & Steel and Cement Industries, etc. CCUS can enable the production of clean products while utilizing our rich endowments of coal, reducing imports and thus leading to an आत्मनिर्भर India economy. CCUS also has an important role to play in enabling sunrise sectors such as coal gasification and the nascent hydrogen economy in India.

Given the importance of this technology, NITI Aayog under the leadership of our Member Dr. V.K. Saraswat has commissioned and supervised this study, which is financed through NITI Aayog's research scheme, following the established protocols and procedures of the scheme. While responsibility for the final output is that of the consultants I am glad to endorse this work to stimulate further work in this important area.

(Suman Bery)





## Foreword

Global warming is a problem facing our planet due to an increase in greenhouse gases in the atmosphere caused by human activities. The rise in the global average temperature due to greenhouse effect, is thought to have serious consequences for various ecosystems.

2. In particular, industrial applications are hard to electrify and industrial CO<sub>2</sub> emissions are hard to abate due to the use of fossil fuels not only as a source of energy but also within the process itself. The application of Carbon Capture Utilization and Storage (CCUS) in the power sector will provide the sustainable opportunities for the reliance on coal for meeting over 70% of its electricity needs of India. Even in the future, if India is able to substantially green the grid power and meet the target of 500 GW installed capacity of renewables by 2030, there would still be a need to meet the baseload power demand from fossil fuels (most likely coal) or other dispatchable sources with the intermittency and non dispatchable nature of solar and wind power. Thus the CCUS will certainly support this aspiration by enabling the clean and green baseload power and ensuring the sustenance and non-stranding of our over 210 GW of coal and lignite based thermal power plants in India.

3. CCUS will also support the transition from |Blue Hydrogen| to Green Hydrogen by accelerating the demand growth and creating technologies and infrastructure for production, storage and transportation of Hydrogen. Conversion of CO<sub>2</sub> to usable chemicals and product will spur the economic development and help achieving some of the Sustainability Development Goals (SDG) like green aggregates, green ammonia and methanol and ultimately green energy.

4. There is a need to design and establish a robust and effective CCUS policy framework to enable viable projects across the CCUS value chain and at scale for the major industrial sectors of the Indian economy like power, steel, cement, chemicals, and petrochemicals.

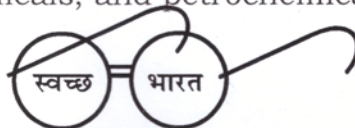

एक कदम स्वच्छता की ओर



5. Further, this study is oriented towards formulating a framework for CCUS policies in India and a viable economic model for CCUS adoption and implementation in various industries and sectors. The study has covered the most of the area required to be considered to implement the CCUS policy in India, as given below:

- a) Whether to pursue an incentive or cash & tax credits based policy or a carbon tax based policy in Indian perspective.
- b) A CCUS cluster framework, design and infrastructure to process, store, sell and transport CO<sub>2</sub> through centralized processing units at each clusters.
- c) Creation of a CCUS business model, institutional framework & opportunity to provide a market & effective price/premium for low-carbon products.
- d) Conceptualize and articulate the need for a CCUS technology and investment enabling carbon fund for India, which will enable CCUS deployments to be financially feasible in India and designing the structure and deployment mechanism for the same.
- e) An industrial CCUS financing framework for the development of a CCUS technology and infrastructure enabling funding mechanism.
- f) Assessment of the socio-economic impact - new industries and job creation with a reduction in overall GHG emissions.

  
(Dr. V. K. Saraswat)

**Place: New Delhi**

**Dated: 03.11.2022**

# Executive Summary



## Carbon Capture, Utilization and Storage is an Essential Imperative for India to Reach its Decarbonization Goals

India is the 3rd largest emitter of CO<sub>2</sub> in the world after China and the US, with estimated annual emissions of about 2.6 gigatonne per annum (gtpa). The Government of India has committed to reducing CO<sub>2</sub> emissions by 50% by 2050 and reaching net zero by 2070. The growth of renewable power capacity has been one of the key success stories of the clean energy transition in India; however, the power sector only contributes to about 1/3 rd of the aggregate CO<sub>2</sub> emissions, which will continue to abate as renewables increasingly replace fossil fuel based power generation. The growing industrial economy emits

close to another third of the aggregate emissions that are hard to abate, and will continue to increase unless new technologies and carbon abatement mechanisms are deployed. At the same time, while India phases down the use of coal over time, India will be dependent on fossil energy sources like coal for a long time to support the industry and meet the requirements for affordable and reliable baseload power. Therefore, India's decarbonization pathway has to also embrace technologies which will abate emissions from the hard to abate industrial sectors as well as for residual baseload power generation.

Figure E-1: The 70% Emissions Challenge

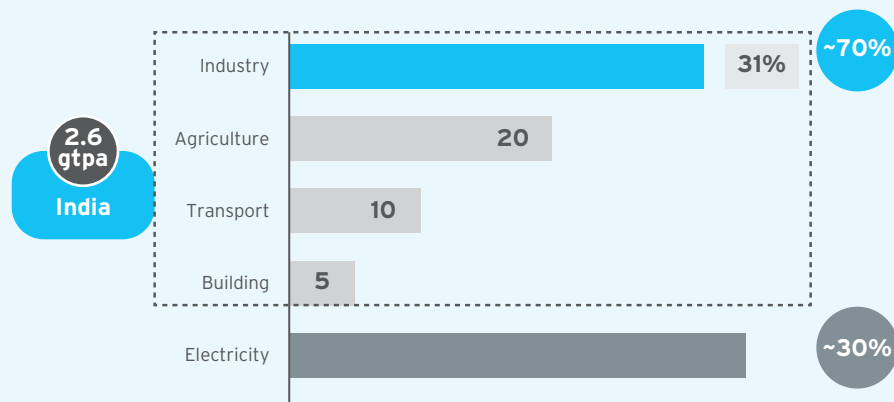

Carbon Capture Utilization and Storage (CCUS) has an important and critical role to play in decarbonizing the industrial sector, which is hard to electrify and hard to abate, due to the use of fossil fuels not only as a source of energy but within the process itself. CCUS also has an important role to play in decarbonizing the power sector, given India's present reliance on coal for meeting over 70% of its electricity needs. Even if India is able to substantially green the grid and meet the target of 500 GW installed capacity of renewables by 2030, there would still be a need to meet the baseload power demand from fossil fuels (most likely

coal) or other dispatchable sources, given the intermittency and non-dispatchable nature of solar and wind power.

Direct Air Capture (DAC) that directly captures dilute CO<sub>2</sub> (415 ppm) from the air, may also emerge as a form of carbon capture that has wide applicability as it is independent of the source and concentration of the emission stream. However, DAC is still in its early stages and the economics (present cost of DAC is estimated to range between US\$ 400-800/tonne of CO<sub>2</sub>) and scale of operations are yet to be established.



## A Policy Driven Approach is Required for CCUS

CCUS is key to ensuring sustainable development and growth in India, particularly for the production of clean products and energy, leading to an आत्मनिर्भर Indian economy. The areas where CCUS can contribute to sustained economic growth in India are manifold:

- Energy, materials & food security and self-sufficiency:** CCUS offers the only known technology for decarbonizing the hard-to-electrify and CO<sub>2</sub>-intensive sectors such as steel, cement, oil & gas, petrochemicals & chemicals, and fertilizers. These sectors are critical to the continued growth of the Indian economy and for ensuring energy, materials and food security for the country.
- Enabling the sunrise sectors of coal gasification and low-carbon hydrogen economy:** CCUS is expected to play a major role in enabling the hydrogen economy in India, through the production of blue hydrogen (i.e. coal gasification based hydrogen production coupled with CCUS) based on the utilisation of India's rich endowments of coal. Given the current cost structure of green hydrogen at US\$ 5-6/kg, cost-competitive blue hydrogen production at around US\$ 2/kg can provide a pathway for the hydrogen economy in the future.
- Sustenance of existing emitters:** Nearly two-thirds of India's 144 mtpa crude steel capacity and 210 GW of coal-based power capacity have an age of less than 15 years and cannot be wished away or stranded and need to be made sustainable by retrofitting with CO<sub>2</sub> capture and disposition infrastructure. Significant economic costs and damages (estimated to be in the range of US\$ 6 billion/year by 2050) can be avoided by ensuring the sustenance of existing emitters by implementing CCUS.

While CCUS enables competitive and sustainable sunrise industries in certain sectors in India, it also imposes costs on other sectors - particularly for the adoption of CCUS by existing emitters. The initial adoption of CCUS implementation in such sectors will impose costs as they start internalizing the negative externality of emission of CO<sub>2</sub> into the atmosphere, whose cost is

currently borne by society. As more CO<sub>2</sub> utilization technologies develop and learning curve effects set in, CCUS costs can come down significantly and new industries around carbon utilization will also develop.

Therefore, to enable the sustainable development of the Indian economy, economy-wide adoption of CCUS will require policy support to initiate and accelerate deployment through economic incentives. These economic incentives can take various forms like tax or cash subsidy on the captured CO<sub>2</sub>, viability gap funding, loan guarantee, demonstration project support and R&D incentives.

## Industrial Sector Needs to be a Key Focus Area for CCUS

India's power and industrial sectors contributed around 1,600 mtpa of CO<sub>2</sub> emissions (around 60%) out of the total emissions of 2,600 mtpa in 2020. The remaining 40% of emissions come from distributed point emissions sources like agriculture, transport, and buildings which are not amenable for CCUS. Fuelled by economic growth across sectors as well as rapid urbanization, emissions from these sectors are expected to increase to nearly 2,300 mtpa by the year 2030, thus making their capture and abatement critical.

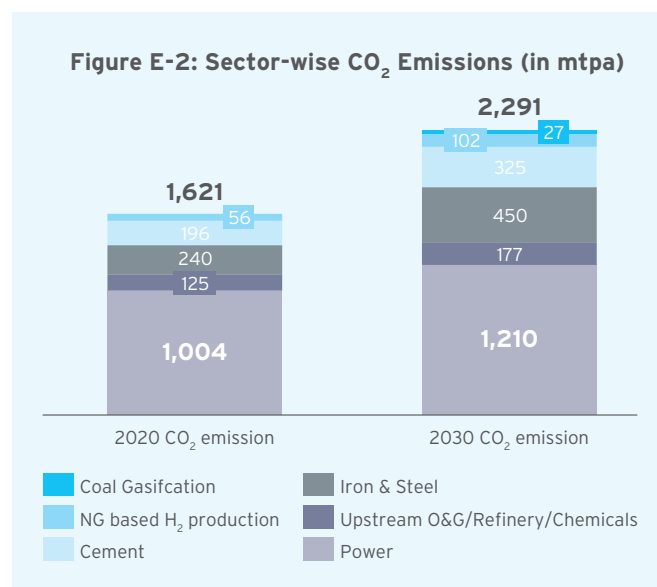

CCUS has an integral role to play in the decarbonization and sustenance of all these industries and sectors, which are critical and vital pillars of the Indian economy.



**Steel:** The future growth of the steel industry in India is largely expected to be based on fossil fuels and the CO<sub>2</sub>-intensive BF-BOF route, given the scarcity of scrap and natural gas in India. CCUS is necessary for ensuring the sustainability of this critical sector of the Indian economy and also ensuring export competitiveness.

CCUS can also enable the scalable and profitable conversion of waste gases from Blast Furnace, Coke Oven and Basic Oxygen Furnaces of Integrated Steel Plants to blue hydrogen at a cash cost of less than Rs. 100 per kg. Blue hydrogen can be used within the steel plant as a source of clean energy or for producing clean DRI. The blue hydrogen can also be sold to external consumers, thus propelling the clean hydrogen economy in India.



**Cement:** Cement is another major CO<sub>2</sub> emitting sector, where fossil fuels are difficult to replace in the cement-making process. The capture, sequestration and conversion of CO<sub>2</sub> to aggregates and other chemical products provide synergies for the cement sector.



**Oil & gas, refineries and chemicals:** This is another hard-to-abate sector, where CCUS is essential for ensuring sustainability. Carbon capture is inbuilt in many of the processes, which makes CCUS costs competitive for this sector.



**Hydrogen production:** The cost-competitive production of blue hydrogen using India's rich coal endowments is key to enabling the hydrogen economy of the future. Carbon capture is inbuilt in the H<sub>2</sub> production process, leading to cost-competitive CCUS.



**Coal gasification:** Coal gasification is a sunrise sector and key to ensuring the materials and energy security of India, based on India's rich endowments of coal. CCUS is critical to enabling the coal gasification economy in India and the production of clean products.



**Thermal power:** Even with the expected growth in renewable energy capacities, coal-based power will continue to meet more than 50% of electricity demand in India in the foreseeable future. As the largest emitter of CO<sub>2</sub>, CCUS of the power sector is essential for meaningful decarbonization and ensuring energy security in India.

## Appropriate Carbon Capture Technologies for Different Applications

There are different categories and types of commercial-scale carbon capture technologies and their suitability or appropriateness for different applications/sectors depends on the typical CO<sub>2</sub> gas stream composition:

- a. **Chemical solvent-based CO<sub>2</sub> capture technologies:** preferred when dealing with gas streams that are lean in CO<sub>2</sub> and have relatively lower pressures, such as flue gas streams from power plants, BF gases in steel plants, gas streams in refineries or chemicals plants. The cost and availability of steam is also a key factor as regenerating the solvent requires large quantities of steam.
- b. **Physical solvent-based CO<sub>2</sub> capture technologies:** these work well on gas streams with relatively higher CO<sub>2</sub> concentration and pressure, such as pre-combustion capture in the case of gasification projects.
- c. **Adsorption-based CO<sub>2</sub> capture:** suitable for gas streams with moderate to high pressure and moderate CO<sub>2</sub> concentration such as SMR flue gas or BF gas.
- d. **Cryogenic CO<sub>2</sub> capture:** preferred in cases where the cost of power is low. This technology can be applied for carbon capture from the PSA tail gas of Steam Methane Reforming Units (for producing H<sub>2</sub>) and provides a unique advantage of increasing the yield/recovery of hydrogen production from the same quantity of feedstock (natural gas).

## Carbon Capture Costs Vary Widely Across Industries/Sectors - Policy Incentives Need to be Appropriately Calibrated

Carbon capture costs (both capital cost and cash cost) vary widely across industries and sectors, and depend on CO<sub>2</sub> source characteristics (mainly pressure & CO<sub>2</sub> concentration), capture technology, power & steam sourcing costs. The estimated CO<sub>2</sub> capture cost curve for demo scale carbon capture projects in each sector is provided below, considering a reference plant size for each sector and CO<sub>2</sub> delivery and disposition at 100 bar (a).

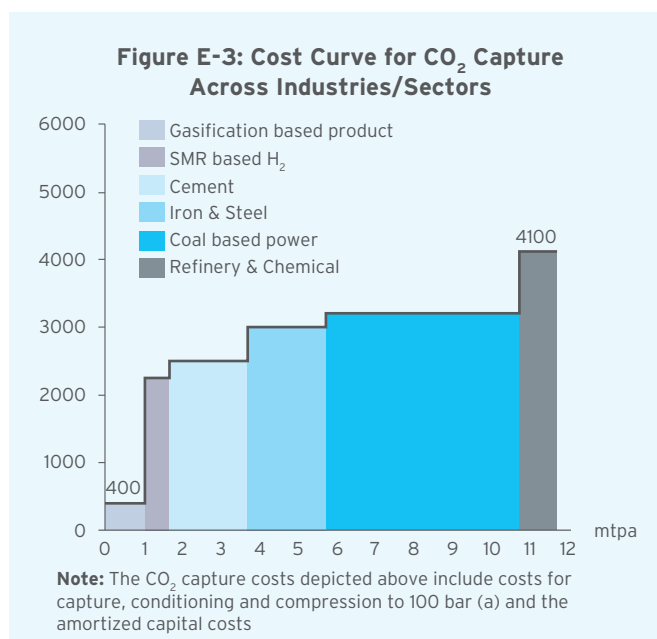

CO<sub>2</sub> capture cost is the lowest for the gasification process, as carbon capture is already integrated within the process. So, the additional cost is only around Rs. 400/tonneCO<sub>2</sub>, required for polishing and compression of the CO<sub>2</sub> stream. The capture costs for other production processes like SMR-based H<sub>2</sub> production, iron & steel, cement, etc. include the costs for gas processing, carbon capture, and compression and are hence higher.

Carbon capture costs are amongst the highest for coal-based power plants, due to the low

concentration of CO<sub>2</sub> in the power plant flue gas stream. However, given the share of the power sector in overall emissions, demo scale CCUS projects in the power sector are also essential for CCUS to meaningfully contribute to decarbonization in India.

## Converting Captured CO<sub>2</sub> to Value Added Products - Opportunity to Profitably Abate CO<sub>2</sub> Emissions

Carbon utilization technologies can provide a wide variety of opportunities to convert the captured CO<sub>2</sub> to value-added products with a ready market in India, thus contributing to the circular economy. The most promising utilization pathways are:

- Green urea:** Green urea can be produced from the captured CO<sub>2</sub> and cost-competitive green hydrogen, from renewable energy based electrolysis of water. Green urea can replace/complement the traditional LNG/NG based production and import of ammonia and urea. The total urea consumption in India is over 30 mtpa, and thus green urea provides a significant opportunity for CO<sub>2</sub> utilization at scale.
- F&B applications:** CO<sub>2</sub> is utilized in F&B applications such as carbonated drinks, dry ice, and modified atmosphere packing; however, the scales are much lower compared to green urea.
- Building materials (concrete and aggregates):** There is a large market for aggregates and concrete in a developing country like India, providing a pathway for utilizing CO<sub>2</sub> for producing building materials through concrete curing and aggregate formation. In these applications CO<sub>2</sub> is injected in a liquid state without any conversion, thus reducing the energy requirements. Additionally, large quantities of wastes such as steelmaking slag are available as sources of CaO/MgO, which can be utilized to produce synthetic aggregates.
- Chemicals (methanol and ethanol):** Conversion of CO<sub>2</sub> to methanol and ethanol from CO<sub>2</sub> is proven at a commercial scale in different parts of the world.

Methanol and ethanol both have important fuel substitution applications; additionally, methanol is an intermediate for the production of value-added chemicals like acetic acid, MTBE, DME, and formaldehyde, all of which have multiple downstream applications and offer significant import substitution opportunities. The conversion of CO<sub>2</sub> to chemicals thus provides a large-scale CO<sub>2</sub> utilization and disposition pathway, given the scale and potential of the downstream chemicals, and can also help in reducing India's import bill, thus laying the foundation for an आत्मनिर्भर economy.

- e. **Polymers (including bio-plastics):** Conversion of CO<sub>2</sub> to various polymers has been attempted globally at different scales, and presents another possible CO<sub>2</sub> utilization route. These polymers have multiple applications, such as laptop packaging, cell phone casings, furniture etc. and provide an interesting futuristic optionality for CO<sub>2</sub> utilization and conversion.
- f. **Enhanced Oil Recovery (EOR):** CO<sub>2</sub> based EOR has been successfully operating for decades for producing low-carbon oil from maturing oil fields in North America and other geographies. For carbon capture projects in India with proximity to oil fields, CO<sub>2</sub> EOR can play a role in residual oil extraction that is environmentally sustainable and economically feasible.

The technology, scale and economics for commercial deployment are important determinants of how existing carbon utilization technologies as well as new technologies develop in India and compete in markets. Policy support for carbon utilization and conversion technologies through offtakes, PLI, price support and R&D incentives will be necessary for carbon utilization markets to develop.

However, one needs to be cognizant of the fact that even with developed carbon utilization technologies, the impact of carbon conversion technologies on carbon abatement through carbon capture and utilization will be modest. The sheer scale of CO<sub>2</sub> emission abatement requires that sequestration be an essential complement to carbon utilization technologies in the CCUS value chain.

## Promoting Innovation, Development, Transfer and Adoption of CCUS Technologies is Key to Rapid Decarbonization in India

Government support and incentivization are needed to promote the adoption and development of CCUS technologies at a commercial scale in India. A multi-pronged approach is recommended:

- a. **Technology transfer:** Technologies for carbon capture, CO<sub>2</sub> sequestration and EOR have been demonstrated at a commercial scale for almost 50 years in many parts of the world and particularly the US. While the development of indigenous technologies is certainly desirable, the immediate focus should be on the transfer, assimilation and adoption of proven TRL 8 and 9 technologies in the CCUS domain. The Government of India may fund CCUS demonstration projects in sectors such as coal-based power, steel, cement, refining & petrochemicals based on commercially proven technologies, thus reducing the technology risks, operational risks and costs for CCUS projects in India and avoiding the reinvention of the wheel. Engagement with technology suppliers is also important to ensure the transfer and indigenization of technology and Intellectual Property (IP). Policy support for the transfer of technology and indigenization will not only support the manufacturing of CCUS equipment for India at a low cost, but also create export opportunities.
- b. **Promoting R&D in novel CO<sub>2</sub> utilization technologies:** CO<sub>2</sub> utilization technologies are relatively less developed, compared to capture technologies. Technologies which have great potential for India, such as CO<sub>2</sub> to methanol and CO<sub>2</sub> to aggregates, are at TRL levels of 4-5 and 6-7 only, respectively. Other propositions such as CO<sub>2</sub> to synthetic fuels, polymers and novel materials like carbon nanotubes are even further behind on the development curve.

The Government of India should promote an ecosystem to foster R&D and innovation in CO<sub>2</sub> utilization technologies and new products & applications based on CO<sub>2</sub> utilization. Similarly, in the area of capture technologies, the Government's policy incentives should encourage R&D in DAC as a possible future option. The developments are multi-faceted and given the difficulty in predicting the innovation and development trajectory, there is a need to fund, foster and incubate innovation-based ecosystems through national centres of excellence such as the National Centre of Excellence in Carbon Capture and Utilization at IIT Bombay.

- c. Private sector participation:** Private sector participation is essential to promote the transfer and commercialization of existing CCUS technologies and also push the envelope for the development of new and emerging technologies, particularly CO<sub>2</sub> utilization technologies. Public/government funding and favourable policies are required to incentivize & de-risk CCUS projects, promote private sector participation and enable viable CCUS business models and value chains to emerge. Similar to the US DOE and UK Infrastructure Bank's support for the development of novel technologies and projects in CCUS, India also needs government institutional frameworks and grants to strategically support new and emerging CCUS technologies, as well as CCUS projects across the full project/funding cycle.

## Geological Storage is Critical for CO<sub>2</sub> Disposition at Scale

For effective CCUS adoption at scale, apart from the conversion of CO<sub>2</sub> to useful value-added products, there needs to be a clear strategy and pathway for the disposition of the captured CO<sub>2</sub> through permanent geological storage. Save any miraculous technological innovation at the commercial scale for carbon abatement technologies, the only commercial large-scale (giga tonne scale) CO<sub>2</sub> disposition option is geological sequestration.

The options for the geological storage of CO<sub>2</sub> include EOR (Enhanced Oil Recovery), ECBMR (Enhanced Coal Bed Methane Recovery) and permanent storage options like saline aquifers and basalt storage. However, the geological data on the pore space availability in India for the storage of CO<sub>2</sub> is limited, especially for saline

aquifers and basaltic storage. In the case of EOR and ECBMR, the data availability is better given the prior exploration activities for facilitating hydrocarbon (both oil & gas and coal) extraction.

Theoretical assessments and estimates by the British Geological Society and IIT Bombay indicate a large potential for CO<sub>2</sub> storage in India, to the tune of 400 - 600 Gt.

**Table E-1: Estimated CO<sub>2</sub> Storage Capacity in India**

<b>EOR</b>	Well established in North America; oil recovery possible to the extent of 30-60%	<b>3.4 Gt</b>
<b>ECBMR</b>	CO <sub>2</sub> injected in unmineable coal seams; further R&D required before commercial deployment	<b>3.5 - 3.7 Gt</b>
<b>Saline aquifers</b>	No economic benefit - but potential of large scale CO <sub>2</sub> storage	<b>291 Gt</b>
<b>Basaltic formations</b>	More recent developments vis-à-vis saline aquifers	<b>97 - 315 Gt</b>
<b>Total</b>		<b>400 - 600 Gt</b>

However, to make the geological storage of CO<sub>2</sub> a reality, further work needs to be supported by the Government of India, especially in the areas of source-sink mapping, pore space mapping, geological characterization of the most promising CO<sub>2</sub> storage regions & basins and developing the CO<sub>2</sub> storage infrastructure through characterization, validation and development of commercial scale (at least 1 mtpa) CO<sub>2</sub> injection programmes in the selected sites. Similar programmes have been funded in the US by the US DOE in the form of a network of seven Regional Carbon Sequestration Partnerships (RCSPs), to develop the regional infrastructure for carbon capture and storage across seven identified regions of the US.

## Supportive Incentive Based Policy Framework is Key to CCUS Adoption in India

A review of carbon capture projects around the world reveals that a policy framework and Government support for CCUS are key to managing project costs & risks, incentivizing the private sector and establishing the CCUS value chain comprising CO<sub>2</sub> capture, transportation and storage.



A carbon credits-based policy is most suited for a developing country like India, to incentivize CCUS adoption and bring down the cost of carbon capture, establish markets for low-carbon products and decarbonize India's large and relatively young industrial asset base by offsetting carbon capture costs. The key elements for the recommended CCUS policy framework for India are:

- a. **Policy path:** CCUS policy in India should be carbon credits or incentives based, to seed and promote the CCUS sector in India through tax and cash credits and provide early stage financing and funding mechanisms for CCUS projects
- b. **Hub & cluster business model:** The policy framework should promote the creation of regional hub & cluster models to drive economies of scale across the CCUS value chain, with defined roles for emitters, aggregators, hub operators, disposers and conversion agents.
- c. **Low carbon products:** Low carbon or carbon-abated products need to be supported through preferential procurement in Government tenders and Production Linked Incentive (PLI) schemes.
- d. **Environmental and social justice:** CCUS policy should protect communities most affected by environmental and climate change by ensuring the distribution of the economic value created by CCUS and the protection of jobs in traditional sectors (viz. coal mining etc.) affected by migration to clean energy systems.
- e. **Accounting and regulatory framework:** To incentivize carbon capture in different sectors, there is a need to establish a baseline of regulated emission levels and allowances for different sectors, and also adopt a Life Cycle Analysis (LCA) framework that looks beyond just the direct Scope 1 emissions and takes into account Scope 2 and Scope 3 emissions and ensures effective carbon abatement.
- f. **Risk mitigation:** For CCUS policy to be effective in India and encourage wider and private sector participation, there is a need to de-risk CCUS projects by limiting the liability and ownership of CO<sub>2</sub> across the CCUS value chain and monitoring risk through appropriate Monitoring, Verification and Accounting (MVA) frameworks.

## Hub and Cluster Model Critical to Drive CCUS Economics and Implementation at Scale

Given the cost and risks associated with CCUS projects, CCUS clusters are necessary to drive CO<sub>2</sub> capture, transport and disposition at scale and create a meaningful decarbonization impact. CCUS clusters incentivize emission-intensive co-located facilities (both industrial facilities and power plants) to form a capture cluster and connect to large-scale CO<sub>2</sub> storage sites using oversized shared transport infrastructure (which can be shared by multiple emitters), as well as options for utilization of CO<sub>2</sub> to produce low carbon downstream products. The anchor project would be large CO<sub>2</sub> emitters, viz. a thermal power plant or a large industrial facility, which can cover the initial infrastructure costs, thereby reducing the cost for new joiners to the cluster. Similarly, CO<sub>2</sub> disposition clusters can be spread across multiple but reasonably closely located geological sequestration sites, oil fields for enhanced oil recovery (EOR) or CO<sub>2</sub> utilization projects.

Emitters and storage sites can connect through storage and transportation hubs, similar to natural gas hubs for the collection and distribution of natural gas across different producers and consumers. The services provided by such hubs would include the compression and transportation of CO<sub>2</sub>, and substantially lower the cost of transportation infrastructure between emitters and CO<sub>2</sub> injection points.

Because of the high mobilization and laying expenses, the economics of CCUS cluster projects in the initial years is quite challenging due to lower CO<sub>2</sub> volumes and the outsized infrastructure created. This can be overcome through long-term and low-cost financing through Government support and access to international clean funds.

Figure E-4: Mega Scale CO<sub>2</sub> Cluster Model

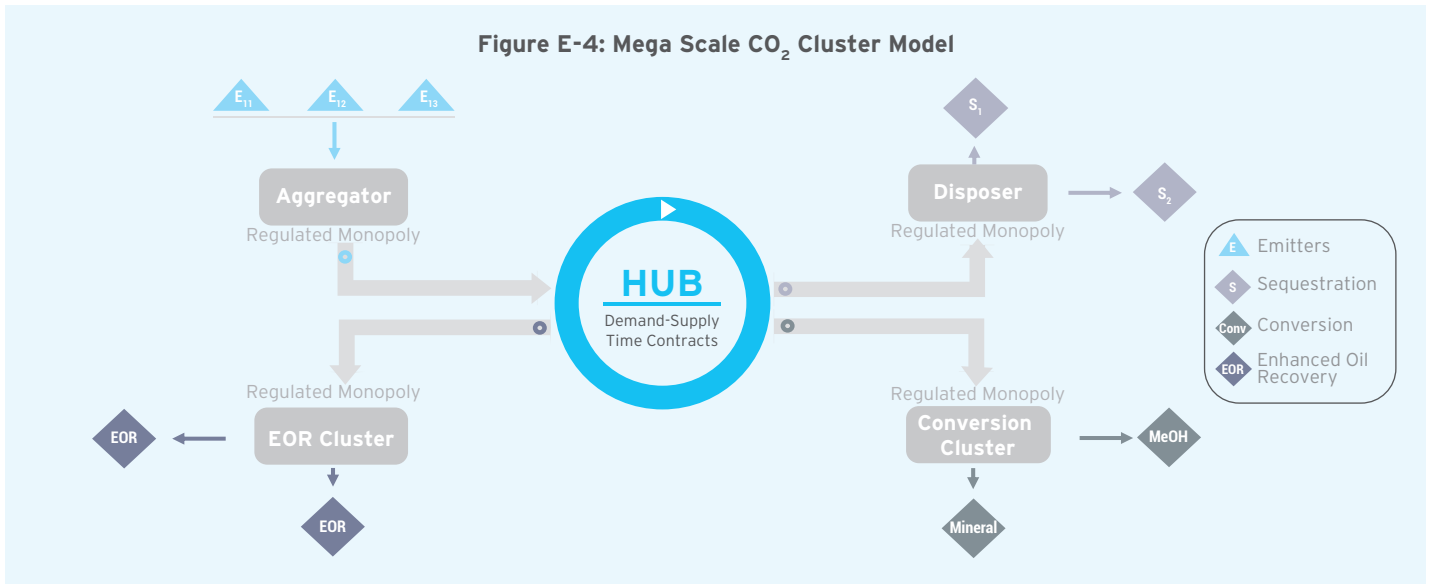

Preliminary analysis shows that there is sufficient potential for creating regional CCUS clusters in each of five regions of India (North, South, East, West, and North-East) and sequestration in deep saline aquifers has the best potential in all the regions. However, due

to the lack of data on the northern sedimentary basins, the theoretical storage capacity for the saline aquifers is low. But as more exploratory activities focused on CO<sub>2</sub> storage are undertaken, the storage potential in the northern region is likely to increase.

Figure E-5: Region-wise Storage Clusters in India

Total Theoretical Storage Capacity of India = 395 - 614 Gt CO<sub>2</sub>

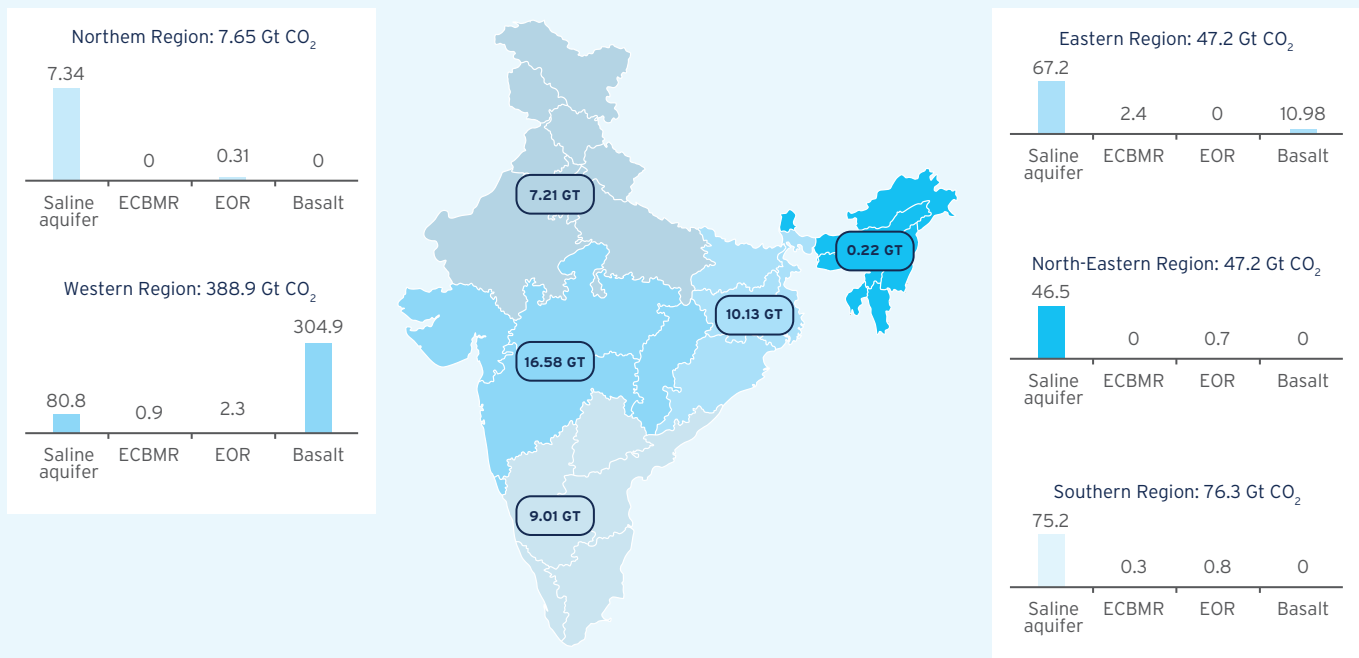

## Carbon Capture Finance Corporation of India – Institutional Mechanism to Support CCUS Project Funding, Capital and Cash Costs

Financing CCUS projects can be quite challenging in a developing country like India, even with incentive and credits-based policy support. For CCUS to take off in India, it is important to fund and support initial demonstration scale CCUS projects. The typical

capital cost and cash costs for CCUS projects in different sectors can be quite different, depending on the source and quality of the gas stream and the extent of CO<sub>2</sub> capture targeted, as shown below.

**Table E-2: Sector-wise Typical Carbon Capture Capital Charge and Cash Cost**

Industry name	Ref. Plant capacity	CCU capacity (mtpa)	Capital Costs, Rs. crores	Capital Charges (A), Rs./T <sub>CO<sub>2</sub></sub>	Cash Cost (B), Rs./T <sub>CO<sub>2</sub></sub>	Total Capture Cost (A+B), Rs./T <sub>CO<sub>2</sub></sub>
<b>Gasification based production</b>	70 ktpa H <sub>2</sub>	1 mtpa	Rs. 80-100 Crore	90-120	250-300	340-420
<b>NG based SMR for H<sub>2</sub> production</b>	130 ktpa H <sub>2</sub>	0.7 mtpa	Rs. 700-800 Crore	900-1,200	1,150-1,400	2,050-2,600
<b>Cement</b>	2.5 mtpa clinker	2 mtpa	Rs. 1,600 to 1800 Crore	800-1,000	1,050-1,600	1,800-2,600
<b>Iron and Steel</b>	2.0 mtpa BF-BOF based ISP	2 mtpa	Rs. 1,600-2,000 Crore	1,000-1,300	1,900-2,300	2,900-3,600
<b>Refinery (CDU &amp; FCC)</b>	5 mtpa crude processing	1 mtpa	Rs. 1,100-1,300 Crore	1,200-1,400	2,700-3,100	3,900-4,500
<b>Coal-based power</b>	800 MW	5 mtpa	Rs. 3,500-4,000 Crore	700-1,000	2,100-2,500	2,800-3,500
<b>Total</b>		<b>11.7 mtpa</b>	<b>Rs. 8,600 - 10,000 Crore</b>			

While the funding for the initial demonstration projects can be achieved through direct Government grants and funds, for CCUS to reach scale in India, it is also important to understand the CCUS investment requirements over a long-term horizon and establish a financial framework such as a Carbon Capture Finance Corporation (CCFC) to support

CCUS projects across their lifecycle. This is important as CCUS provides an unmatched opportunity for turbocharging the growth of the Indian economy by creating a clean-energy based industrial sector, potentially leading to the development of new technologies, skills and high-value employment opportunities in India.



It is estimated that out of the total emissions emanating from sectors such as coal-based power, steel, cement, upstream oil & gas operations, refineries, chemicals, hydrogen production and gasification, about 85% will be capturable through CCUS projects. Based on the trajectory of economic & industrial development in India and the concomitant growth in CO<sub>2</sub> emissions, it is expected that the capturable emissions will reach about 2400 mtpa by the year 2050, the year by which India has committed to halving its emissions. For CCUS to make a meaningful contribution to this lofty and laudable goal, it is envisaged that CCUS projects should capture at least 30% of the capturable emissions of 2400 mtpa, i.e. around 750 mtpa. To sufficiently incentivize CCUS projects at the envisaged scale, the following subsidies are suggested:

- a. Subsidy for CO<sub>2</sub> sequestration/storage:** Rs. 4,100/tonne till 2040 and Rs. 3,000/tonne till 2050
- b. Subsidy for CO<sub>2</sub> EOR:** Rs. 3,000/tonne till 2040 and Rs. 2,400/tonne till 2050
- c. Subsidy for CO<sub>2</sub> utilization:** Rs. 2,300/tonne till 2050

The above subsidy amounts have been estimated based on the likely CCUS costs in the Indian context and the likely trajectory of cost reduction from the increasing scale of CCUS projects, and also the revenue streams from CO<sub>2</sub> EOR or the conversion of CO<sub>2</sub> to value-added products.

The total subsidy amount required by the year 2050 to support 750 mtpa of CCUS is estimated to be around Rs. 210,000 crores. While this is a very significant amount, it is a necessary expenditure required to support CCUS and ensure the sustainability of the Indian economy. It is proposed that the proposed CCFC be developed as a financial institution to fund CCUS projects through

equity and debt participation, with the objective of supporting and realizing the carbon neutrality goal. The CCFC will be funded by low-cost sovereign or International Green Funds, Carbon Bonds or Climate Funds. By investing in CCUS projects, along with the utilization of a part of the incremental tax revenue generated, it should be possible to fund the carbon capture credits, eventually leading to subsidy-neutral CCUS operations. Two alternate mechanisms are proposed to fund the CCFC.

**a. Option 1: CCUS financing through 'Clean Energy Cess' only**

It is assumed that CCUS will be funded by the Clean Energy Cess' levied on coal. The 'Clean Energy Cess' on coal @ USD 5.3/tonne (Rs. 400 per tonne) will be re-introduced from 1 April 2026, as the GST compensation cess has been extended till 31 March 2026. India's coal and coke consumption is expected to increase from the current 1,050 mtpa to around 1,200 mtpa by 2030 at a 2% CAGR. Accordingly, the annual cess collection is estimated to be around USD 6-7 BB\$ (Rs. 48,000 - 53,000 crores). The surplus funds in the initial period creates an opportunity for the corpus to grow significantly through re-financing through appropriate investment vehicles.

**Table E-3: CCUS Funding through Clean Energy Cess**

Year	Fund. Req., Thou. crore	Fund available, Thou. crore	Surplus/Shortfall, Thou. crore
2023	-	23	23
2030	15	169	154
2040	89	603	514
2050	210	225	15

**b. Option 2:** CCUS financing through bond and gross budgetary support

The government budget and bonds will finance the subsidy (cash and tax credits) required for CCUS. It is estimated that 30.5 BB\$ (Rs. 2,29,000 crores) of bonds with a 9% spread in re-investment return, along with a maximum of 0.5% of the Government's spending or the 'Gross Budgetary Support (GBS)' can finance 750 mtpa of CCUS by 2050.

It is proposed that the bonds will be raised from the low-cost national/international bond market and invested in green projects in India with an assured return of 9% spread. While the bonds will be raised and re-invested in the initial years, projected utilization has been estimated to limit the government spending on CCUS to be about 0.5% of the 'Gross Budgetary Support'.

**Table E-4: CCUS Funding with Bonds and Government Budgetary Support**

Year	Fund. Req., Thou. crore	Bond with Return, Thou. crore	Gross Budgetary Support (GBS), Thou. crore
2023	-	-	-
2030	15	-	15 (0.2% of GBS)
2040	89	36	53 (0.4% of GBS)
2050	210	107	103 (0.5% of GBS)

## CCUS will have a Material Positive Impact on GDP, Employment Growth, Energy and Material Security, and Import Substitution

CCUS projects will require upfront capital investments of US\$ 100-150 billion [2022 dollars] for 750 mtpa of CO<sub>2</sub> capture, utilization, and storage. These investments will develop the market for CO<sub>2</sub> and the positive impact on the Indian GDP is estimated as US\$ 100 to 150 billion over the next 30 years, based on the envisaged improvement and indigenization of CCUS technology.

In particular, CCUS-enabled coal gasification projects will generate clean value-added products like methanol, ammonia, acetic acid, mono-ethylene glycol, etc. and reduce their imports significantly. India imports almost US\$ 13 billion per annum of organic chemicals and it is estimated that the

indigenous production of these coal-based chemicals can replace US\$ 7-10 billion of imports by 2050 and also contribute to the domestic GDP.

CCUS projects will also lead to significant employment generation, both during the construction phase and the operating phase, as well as create significant indirect employment and shape the future economic development of nearby areas. It is estimated that the envisaged CCUS target of 750 mtpa by 2050 can create employment opportunities of 8-10 million full time equivalent (FTE) years in a phased manner, thus creating a compelling case for investment in CCUS projects.

# Chapter 1

# Introduction





## 1.1 Background

India is the 3rd largest emitter of CO<sub>2</sub> in the world after China and the US, with estimated emissions of 2.6 gigatonne per annum (gtpa) in 2019, which marginally reduced to 2.45 gtpa in 2020 due to the impact of the COVID-19 pandemic. India's per capita CO<sub>2</sub> emissions are about 1.9 tonnes per annum, which is less than 40% of the global average and about one-fourth of that of China. However, with rapid economic growth, infrastructure and industrial

development, as well as a growing population (expected to overtake China in the next decade and cross 1.50 billion by 2036), the total CO<sub>2</sub> emissions is expected to cross 4 gtpa by the year 2030. The sectoral break-up of the CO<sub>2</sub> emissions reveals that while renewable energy is making great strides in India, it can theoretically contribute at most 30% of the desired decarbonization by replacing fossil fuel-based power generation.

Figure 1.1: The 70% Emissions Challenge

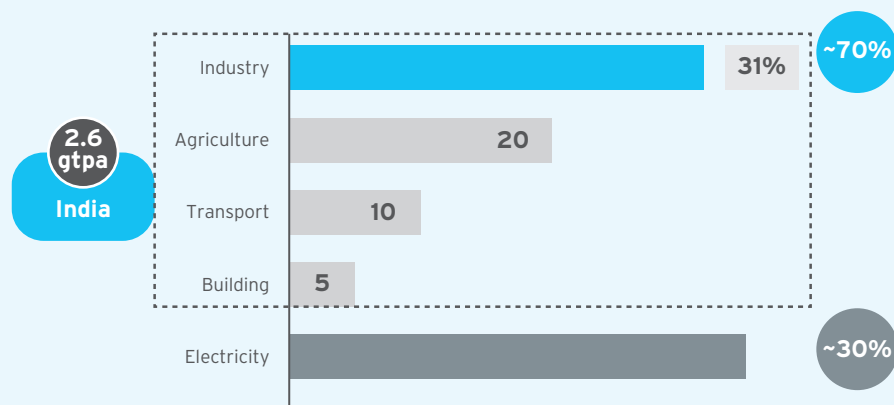

### What is CCUS?

The International Energy Agency (IEA) defines Carbon Capture, Utilization and Storage (CCUS) as a group of technologies for capturing of CO<sub>2</sub> from large and stationary CO<sub>2</sub> emitting sources, such as fossil fuel based power plants and other industries. CCUS also involves the transport of the captured CO<sub>2</sub> (typically by pipeline and in certain situations by through shipping, rail or trucks also) to sites, either for utilization in different applications or injection into geological formations or depleted oil & gas fields for permanent storage and trapping of the CO<sub>2</sub>.

CCUS also includes Direct Air Capture (DAC), which involves the capture of CO<sub>2</sub> directly from the atmosphere, although the same is not the focus of this study, as DAC is still in its early stages and the economics (present cost of DAC is estimated to range

between US\$ 400-800/tonne of CO<sub>2</sub>) and scale of operations are yet to be established.

### Decarbonization Challenge and the Role of CCUS

The decarbonization challenge for India is to identify scalable and economically sustainable solutions for the decarbonization of sectors that contribute to 70% of emissions. CCUS has an important and critical role to play, especially for India to accomplish net-zero by 2070, as envisioned by the Hon'ble Prime Minister of India. Though the target date is five decades away, as the noted author Vaclav Smil has documented in his work, energy transitions take decades. It is therefore important to implement the framework and policy instruments for CCUS to become a reality in India and make a meaningful contribution to decarbonization in India.

This study has been prepared by M. N. Dastur & Co. (P) Ltd. and Dastur Energy Pvt. Ltd., under the tutelage of the National Institution for Transforming India (NITI Aayog), Government of India and aims to provide the policy framework and deployment mechanism for CCUS at scale to become a reality in India. This study focuses on CCUS for large point CO<sub>2</sub> emission sources (with >100 ktpa of CO<sub>2</sub> emissions) such as coal based power plants and industrial applications. CO<sub>2</sub> emissions from sectors such as agriculture, transportation and buildings are distributed and require interventions related to change in fuel (viz. biofuels), electrification, enhancing thermal & electrical efficiencies and are outside the purview of this study.

In particular, industrial applications are hard to electrify, and industrial CO<sub>2</sub> emissions are hard to abate due to the use of fossil fuels not only as a source of energy but also within the process itself. Carbon Capture Utilization and Storage (CCUS) also has applications for the power sector, given India's present reliance on coal for meeting over 70% of its electricity needs; even in the future, if India is able to substantially green the grid power and meet the target of 500 GW installed capacity of renewables by 2030, there would still be a need to meet the baseload power demand from fossil fuels (most likely coal) or other dispatchable sources, given the intermittency and non-dispatchable nature of solar and wind power. Thus, CCUS also has a role to play in enabling clean and green baseload power and ensuring the sustenance and non-stranding of our over 210 GW of coal and lignite based thermal power plants.

In their September 2020 report, the International Energy Agency points out that reaching net-zero without CCUS is virtually impossible. The Intergovernmental Panel on Climate Change (IPCC) also concludes that without CCUS, it would not be possible to stabilize the CO<sub>2</sub> concentration in the atmosphere between 450 - 750 ppmv (parts per million by volume) and limit global temperature rise between 1.5 to 2 degrees Celsius above pre-industrial levels.

The adverse climatic effects of a rise in GHG emissions and global temperatures rises are well established and proven, and India too has not been spared from adverse climatic events. As a signatory of the Paris Agreement 2015, India has committed to reducing emissions by 50% by the year 2050 and reaching net zero by 2070. Given the sectoral composition and sources of CO<sub>2</sub> emissions in India, CCUS will have an important and integral role to play in ensuring India meets its stated climate goals, through the deep decarbonization of energy and CO<sub>2</sub> emission intensive industries such as thermal power generation, steel, cement, oil & gas refining, and petrochemicals. CCUS can enable the production of clean products while utilizing our rich endowments of coal, reducing imports and thus leading to an **आत्मनिर्भर** Indian economy. CCUS also has an important role to play in enabling sunrise sectors such as coal gasification and the nascent hydrogen economy in India.

## 1.2 Global CCUS Landscape

Globally there are about 21 CCUS facilities, with a capacity of capturing about 40 mtpa of CO<sub>2</sub> or only 0.1% of the 40 gtpa global annual GHG emissions. The first CCUS projects started in the 1970s and 1980s in Texas for capturing CO<sub>2</sub> from natural gas processing plants and supplying it to local oil producers for utilizing the CO<sub>2</sub> for Enhanced Oil Recovery. Since

then, CCUS has spread to other regions and countries, viz. Norway, Canada, Australia, Brazil, Canada, China, Saudi Arabia and the United Arab Emirates. A list of the operating CCUS facilities as of 2020 is tabulated in Table 1-1. The extent of public funding support provided to these CCUS facilities (where applicable) is also provided.

Table 1-1: Large Scale CCUS facilities in operation in 2020

Country	Project	Operations start	CO <sub>2</sub> source	Public funding	Funding sources	CO <sub>2</sub> capture capacity (mtpa)	CO <sub>2</sub> disposition
USA	Terrell natural gas plants (earlier Val Verde)	1972	Natural gas processing	No	Capital cost: US\$ 27.6 mn	0.5	EOR
USA	Enid fertiliser	1982	Fertilizer production	No	Not available	0.7	EOR
USA	Shute Creek gas processing facility	1986	Natural gas processing	No	Initial cost - US\$ 170 mn Expansion cost - US\$ 80 mn	7.0	EOR
Norway	Sleipner CO <sub>2</sub> storage project	1996	Natural gas processing	No	Project cost - US\$ 100 mn	1.0	Storage
USA/Canada	Great Plains Synfuels (Weyburn/Midale)	2000	Synthetic natural gas	Yes	Project cost - US\$ 80 mn US DOE funding - US\$ 3 million Canadian Govt. funding- US\$ 2 mn	3.0	EOR
Norway	Snohvit CO <sub>2</sub> storage project	2008	Natural gas processing	No	Not available	0.7	Storage
USA	Century plant	2010	Natural gas processing	No	Project cost - US\$ 1.1 bn	8.4	EOR
USA	Air Products steam methane reformer	2013	Hydrogen production	Yes	Project cost - US\$ 431 mn US DOE funding - US\$ 284 mn (through the American Recovery and Reinvestment Act)	1.0	EOR
USA	Lost Cabin Gas Plant	2013	Natural gas processing	No	Project cost - US\$ 400 mn	0.9	EOR
USA	Coffeyville Gasification	2013	Fertilizer production	No	Not available	1.0	EOR
Brazil	Petrobras Santos Basin pre-salt oilfield CCS	2013	Natural gas processing	No	Not available	3.0	EOR
Canada	Boundary Dam CCS	2014	Power generation (coal)	Yes	Project Cost - CA\$ 1.35 bn Federal Govt. support - CA\$ 240 mn	1.0	EOR
Saudi Arabia	Uthmaniyah CO <sub>2</sub> -EOR demonstration	2015	Natural gas processing	No	Not available	0.8	EOR
Canada	Quest	2015	Hydrogen production	Yes	Project cost- CAD 1.35 bn Federal Govt. support - CA\$ 120 mn Alberta Govt. - CA\$ 745 mn	1.0	Storage

Country	Project	Operations start	CO <sub>2</sub> source	Public funding	Funding sources	CO <sub>2</sub> capture capacity (mtpa)	CO <sub>2</sub> disposition
UAE	Abu Dhabi CCS	2016	Iron and steel production	Yes	Pipeline capex - US\$ 200 mn	0.8	EOR
USA	Petra Nova	2017	Power generation (coal)	Yes	Project cost - US\$ 1 bn US DOE - US\$ 167 mn NRG Energy - US\$ 300 mn JX Nippon - US\$ 300 mn Debt funding from Japan Bank for International Cooperation & Mizuho Bank - US\$ 250 mn	1.4	EOR
USA	Illinois Industrial	2017	Ethanol production	Yes	Project cost - US\$ 208 mn US DOE support - US\$ 142 mn	1.0	Storage
China	Jilin oilfield CO <sub>2</sub> -EOR	2018	Natural gas processing	No	Phase 1 cost - US\$ 11 mn	0.6	EOR
Australia	Gorgon Carbon Dioxide Injection	2019	Natural gas processing	No	Project total cost - US\$ 55 bn Injection capex - US\$ 2 bn Commitment from Australian Govt. - US\$ 60 mn	3.4 - 4.0	Storage
Canada	Alberta Carbon Trunk Line (ACTL) with Agrium CO <sub>2</sub> stream	2020	Fertilizer production	No	Capital cost - US\$ 27.6 mn	0.3 - 0.6	EOR
Canada	ACTL with North West Sturgeon Refinery CO <sub>2</sub> stream	2020	Hydrogen production	No	Capital cost - US\$ 27.6 mn	1.2 - 1.4	EOR

**Note:** Large scale CCUS: at least 0.8 mtpa of CO<sub>2</sub> capture for coal based power plant and at least 0.4 mtpa for other industrial facilities, including NG based power

**Source:** International Energy Agency, MIT database, Dastur research

CCUS deployment has mostly been concentrated in the US, due to the low cost of capture from NG processing facilities, CO<sub>2</sub> demand for EOR, CO<sub>2</sub> pipeline networks and Government funding for CCUS. The 2010 to 2020 time period was largely a decade of misses for CCUS, with CCUS capacity only reaching 40 mtpa, vis-à-vis the IEA 2009 roadmap of 100 CCUS projects with a capture capacity of 300 mtpa. However, recent years have seen renewed global interest in CCUS, particularly after the Paris climate

agreement of 2015, global focus and pledges on reaching net-zero and the realization that renewable energy can only solve a part of the decarbonization challenge. Over 100 new CCUS projects have been announced in the recent past, which are expected to become operational by 2030 and take the aggregate carbon capture capacity to 150 mtpa. These projects span across regions (including many developing countries) and are geared towards a diverse mix of CO<sub>2</sub> applications and disposition options.

## 1.3 Decarbonization Through CCUS

CCUS can contribute to decarbonization and transition to clean energy systems in various ways:

- a. **Hard-to-abate sectors:** CCUS offers the only known technology for the decarbonization of hard-to-electrify CO<sub>2</sub> intensive sectors such as steel, cement, oil & gas, petrochemicals & chemicals, and fertilizers. These sectors are important to the continued growth of the Indian economy and for ensuring energy, materials and food security. The maturity of technology development in these sectors portends the continued use of fossil fuels and concomitant CO<sub>2</sub> emissions from these sectors in the foreseeable future, thus making CCUS critical in these sectors.
- b. **Low carbon hydrogen economy:** CCUS is expected to play a major role in enabling the hydrogen economy in India, through the production of blue hydrogen based on the utilization of our rich endowments of coal. Given the current cost structure of green hydrogen of US\$ 5-6/kg, cost competitive blue hydrogen production (i.e. coal gasification based hydrogen production coupled with CCUS) at around US\$ 2/kg can provide a pathway for the hydrogen economy in the future.
- c. **Removal of the CO<sub>2</sub> stock from the atmosphere:** The race towards net zero and containing global temperature within 1.5 degrees from pre-industrial levels is not possible without the removal of excess CO<sub>2</sub> from the atmosphere through Direct Air Capture (DAC). DAC plants are in operation at a small scale, due to their prohibitively high cost of operations. With technological innovation and focused policy interventions, CCUS through DAC applications is also expected to have a role in the net-zero transition journey.
- d. **Sustenance of existing emitters:** Existing thermal power plants and industrial plants (such as steel and cement production facilities) can be retrofitted with CO<sub>2</sub> capture infrastructure. Nearly two-thirds of India's 210 GW of coal-based power capacity and 144 mtpa crude steel capacity have an age of less than 15 years and cannot be just

wished away or stranded and need to be made sustainable through the application of CCUS. Significant economic costs and damages can be avoided by ensuring the sustenance of existing emitters through the implementation of CCUS. As per estimates provided in the article *"Understanding initial opportunities and key challenges for CCUS deployment in India at scale"* by Professors Vikram Vishal, Debanjan Chandra, Udayan Singh, Yashvardhan Verma, by year 2050, about US\$ 6 billion/year of economic damage can be avoided through CCUS.

## 1.4 The CCUS Value Chain

Carbon capture has a critical role to play in the decarbonization of hard to abate sectors and the path towards the net zero transition. However, in order to deploy carbon capture at scale, it is important to look beyond just carbon capture technologies, and holistically look at the CCUS value chain. The CCUS value chain consists of three basic components (source: Medlock, III, Kenneth B. and Keily Miller, "Expanding Carbon Capture in Texas", Baker Institute Center for Energy Studies, January 2021):

- i) Capture of carbon dioxide (CO<sub>2</sub>) from fuel combustion or industrial gas streams, compression, dehydration & purification of CO<sub>2</sub> to the desired specifications;
- ii) Transport of the CO<sub>2</sub> (generally via pipeline) to the CO<sub>2</sub> sink
- iii) Disposition of the CO<sub>2</sub>, either through utilization in applications such as Enhanced Oil Recovery (EOR), food and beverage applications, or the production of value-added products (viz. urea, green methanol, cured concrete) or through sequestration of CO<sub>2</sub> in permanent geological storages

The success of the CCUS value chain depends on the actors in each part of the CCUS value chain acting in close coordination with each other. In order to incentivize coordination between actors across the CCUS value chain, there is a need for an appropriate enabling policy framework and business model.



## 1.5 CCUS in India

Presently carbon capture in India is confined to certain industries/applications where the carbon capture is part of the process, viz., the manufacture of urea. India's urea production is about 24 mtpa, where capture CO<sub>2</sub> is utilized in the ammonia to urea conversion process. CO<sub>2</sub> is also captured as part of the gas conditioning process in the gasifiers of Reliance Industries Limited in Jamnagar (10 mtpa of petcoke gasification capacity) and JSPL in Angul (2 mtpa of coal gasification capacity), but the CO<sub>2</sub> is largely released to the atmosphere and not utilized or stored. While there are few pilot scale carbon capture projects (viz. IOCL R&D's amine and biological enzyme based carbon capture plant and Tata Steel Jamshedpur's pilot scale carbon capture plant for capturing 5 tonnes per day CO<sub>2</sub> from Blast Furnace gases), there are no commercial-scale dedicated CCUS projects in India.

While the sustainability of operations and carbon footprint is a major concern for the promoters and top management of most industries, the main impediments to companies investing in CCUS projects are the lack of any policy incentives and framework, lack of a viable or established business model with independent players providing services for the transportation and disposition of CO<sub>2</sub> and lack of established pathways & options for the utilization or storage of CO<sub>2</sub> at scale.

Given India's climate and CO<sub>2</sub> emission reduction commitments, there is a need to design and establish a robust and effective CCUS policy framework to enable projects across the CCUS value chain and at scale for the major industrial sectors of the Indian economy like power, steel, cement, chemicals, and petrochemicals.



## 1.6 Objectives of the Study

Against this backdrop, this study seeks to formulate a framework for CCUS policies in India and a viable economic model for CCUS adoption and implementation in various industries and sectors. The objectives of the study are as follows:

- a. Recommend the most suitable CCUS policy instrument & path for India, i.e. whether to pursue an incentive or cash & tax credits based policy (similar to the USA) or a carbon tax based policy (similar to the EU)
- b. A CCUS cluster framework: cluster design and infrastructure to process, store, sell and transport CO<sub>2</sub> through centralized processing at each cluster.
- c. Creation of a CCUS business model, institutional framework & opportunity: to provide a market and an effective price/premium for low-carbon products.
- d. Conceptualize and articulate the need for a CCUS technology and investment enabling carbon fund for India, which will enable CCUS deployments to be financially feasible in India; designing the structure and deployment mechanism of the same
- e. An industrial CCUS financing framework: development of a CCUS technology and infrastructure enabling funding mechanism.
- f. Assessment of the socio-economic impact - promoting new industries and job creation with a reduction in overall GHG emissions

## 1.7 Structure of this Study

This study consists of the following chapters:

### Executive Summary

- Chapter 1** : Introduction
- Chapter 2** : Analysis of Sector-wise CO<sub>2</sub> Emissions
- Chapter 3** : Overview of CO<sub>2</sub> Capture & Utilization Technologies
- Chapter 4** : Potential for CO<sub>2</sub> Storage in India
- Chapter 5** : CCUS Policy Framework for India
- Chapter 6** : Investment and Financing Mechanism
- Chapter 7** : Conclusions

## 1.8 Acknowledgement

We express our sincere gratitude and grateful acknowledgement to the NITI Aayog, and especially Dr V. K. Saraswat (Member, NITI Aayog), Shri Rajnath Ram (Adviser - Energy) and Shri Jawahar Lal (Deputy Chief Engineer, Energy) for the guidance and cooperation extended during this study.



## Chapter 2

# Analysis of Sector-wise CO<sub>2</sub> Emissions



## 2.1 Introduction

The total CO<sub>2</sub> emissions from a system can be categorized into three types (Figure 2-1)

**a) Direct or scope 1 emissions:** Emissions from the production process from the combustion of fuel. This typically occurs within the plant/facility premises.

**b) In-direct or scope 2 emissions:** Emission associated with the purchase of utilities. This is generally an emission outside the plant boundary.

**c) In-direct or scope 3 emissions:** Indirect emissions are associated with the entire value chain, starting from equipment purchase, construction works, raw material sourcing and product dispatch.

Figure 2-1: Illustration of Emission Types and Boundary Consideration

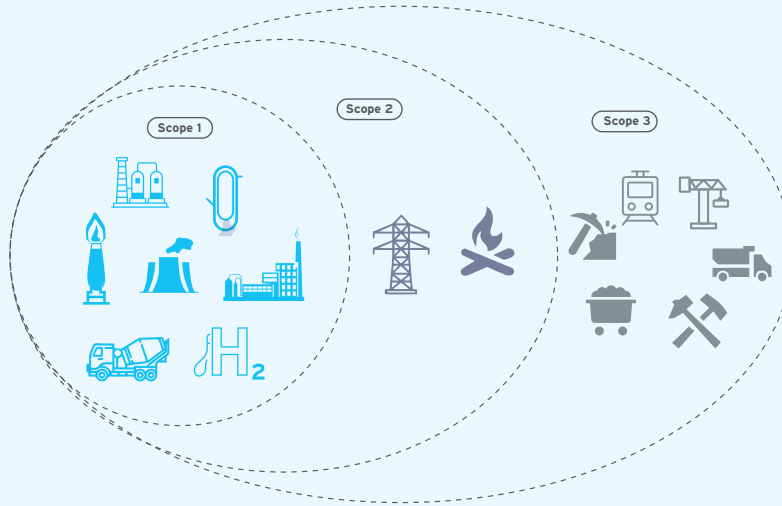

The objective of this chapter is to estimate the capturable CO<sub>2</sub> volume within the plant boundary for different target sectors; accordingly, Scope 1 emissions have been estimated for the target sectors.

India’s power and industrial sectors contributed around 1,600 mtpa of CO<sub>2</sub> emission (around 60%) out of 2,600 mtpa in 2020. The remaining 40% CO<sub>2</sub> emissions are contributed by distributed point emissions sources like agriculture, transport, and buildings. Since carbon capture, utilization and storage are not applicable for such sources, this chapter focuses on power and key industrial sectors. Emissions from these sectors are expected to increase to nearly 2,300 mtpa by the year 2030, fuelled by industrial growth across multiple sectors as well as rapid urbanization. The sector-wise emissions (current and projected) are shown in Figure 2-2.

Figure 2-2: Sector-wise CO<sub>2</sub> Emissions, mtpa

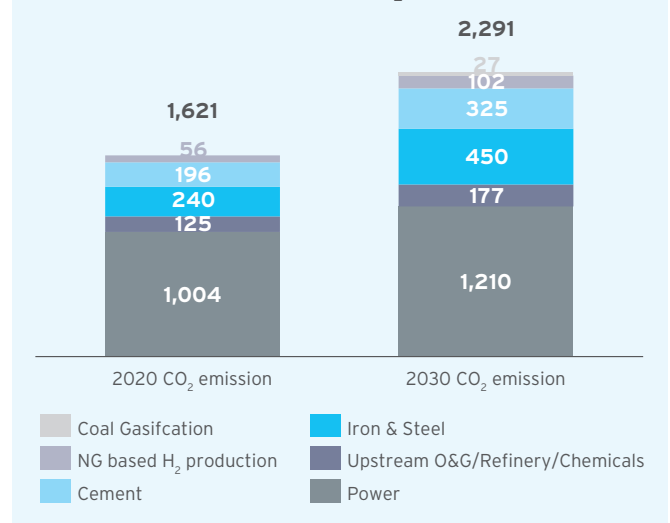

## 2.2 Analysis of Major Industrial CO<sub>2</sub> Sources (Power, Steel, Chemicals, Cement & Gasification) in India

### 2.2.1 CO<sub>2</sub> Emissions: Indian Power Industry

#### 2.2.1.1 Introduction

Being the third-largest producer and second-largest consumer of electricity, the Indian power sector plays a major role in the world energy scenario (IBEF, 2021). India generated a total of 1382 TWh of electricity in FY 2020-21, about 2.5% less than the total generation in FY 2019-20 (Ministry of Power Annual Report, 2020-21).

Given our rich endowments of coal, the major portion of power demand is met by coal and lignite based thermal power plants, along with power plants based on other fossil fuels (natural gas and diesel). At the same time, the last decade has seen considerable additions of renewable energy generation capacity to the energy mix, towards the path of achieving India's goal of achieving 175 GW of renewable energy capacity by 2022 (IEA, India Energy Outlook, 2021). India has also committed to generating 40% of electricity in the future from non-fossil fuel sources (IEA, India Energy Outlook, 2021). While the share of fossil fuel-based energy is expected to reduce going forward, energy

demand is also expected to increase significantly from the present levels, i.e., 25-30% by 2030 and 60-70% by 2040 (IEA, India Energy Outlook, 2021). The major share of the power demand will continue to be met from coal in the foreseeable future, in order to secure India's energy security and ensure electricity for every household. Thus, the power sector will continue to be a major source of GHG emissions, and hence CCUS is of prime importance for the abatement of CO<sub>2</sub> from the sector.

#### 2.2.1.2 Installed Capacity and Power Generation

As of January 2022, India's total electricity generation capacity was 395 GW, including 106 GW of renewable energy capacity (Figure 2-3). Fossil fuels like coal, natural gas, lignite, and diesel) contribute to almost 60% of total generation capacity, with coal-based thermal power capacity alone accounting for around 52% (203 GW). The installed capacity of renewables like solar, wind, biomass, etc. has increased significantly in the last two years. Renewable capacity has increased from 86 GW to 106 GW, an increase of 23% whereas total capacity has increased by only 7%.

Figure 2-3: Break-up of Installed Generation Capacity, GW

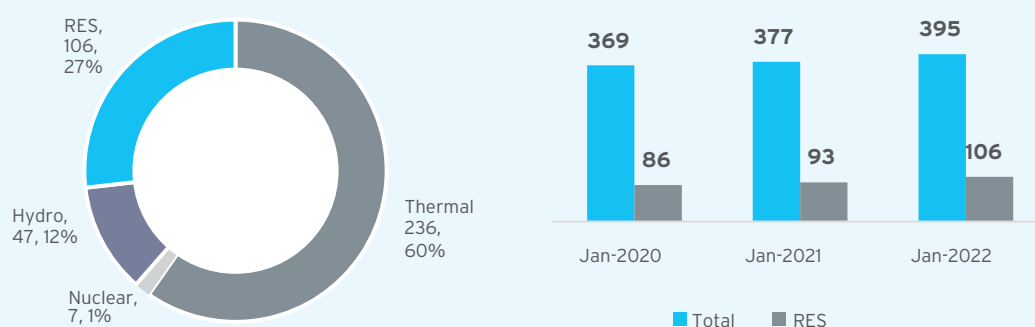

Source: CEA

Though renewables contribute to around 30% of the current capacity mix, due to their intermittent and non-dispatchable nature, their share in power generation was only 11% in FY 2021-22 (Figure 2-4). Thus going forward also, even as India targets to reach 450 - 500 GW of renewables capacity by the year 2030, coal-based power generation will continue to play an important role in the power mix of India.

**Figure 2-4: Break-up of Generation, Billion Unit (Ministry of Power Annual Report, 2020-21)**

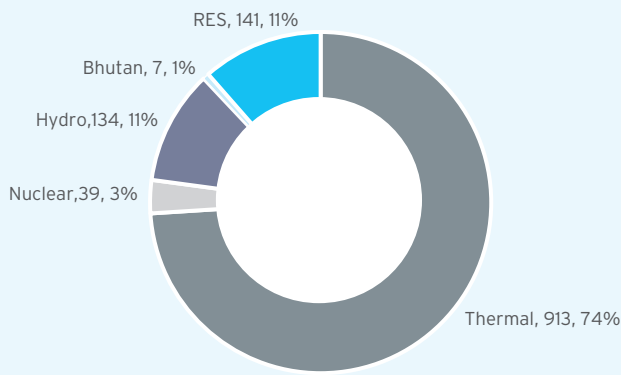

**2.2.1.3 Brief Description of Thermal Power Plants**

The basic principle behind the working of a thermal power plant is that they generate electricity using the thermal energy from the combustion of fuels. Based on the type of fuel used, thermal power plants can be divided into four categories, coal, natural gas, lignite,

and diesel. The share of diesel-based power capacity in India is minimal; the major share of capacity is from coal-powered thermal power plants, followed by natural gas.

**Figure 2-5: Break-up of Thermal Power Plants by Fuel (Power Sector at a Glance ALL INDIA)**

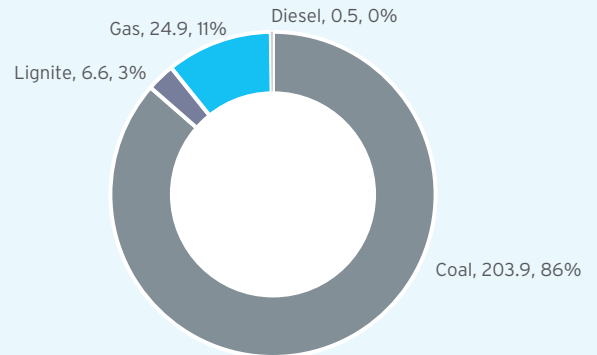

The process flow of power generation from coal (process flow for lignite is also similar) and natural gas-based power plants is described below.

**a) Coal-fired thermal power plant**

Coal-fired thermal power plants generate electricity by burning coal as a fuel and using the heat to produce steam from water. The steam is used to generate electricity by passing through a steam turbine generator. The various unit operations involved in this process are illustrated in Figure 2-6 (Breeze, 2019).

**Figure 2-6: PFD of Coal-fired TPP [Reproduced from (Breeze, 2019)]**

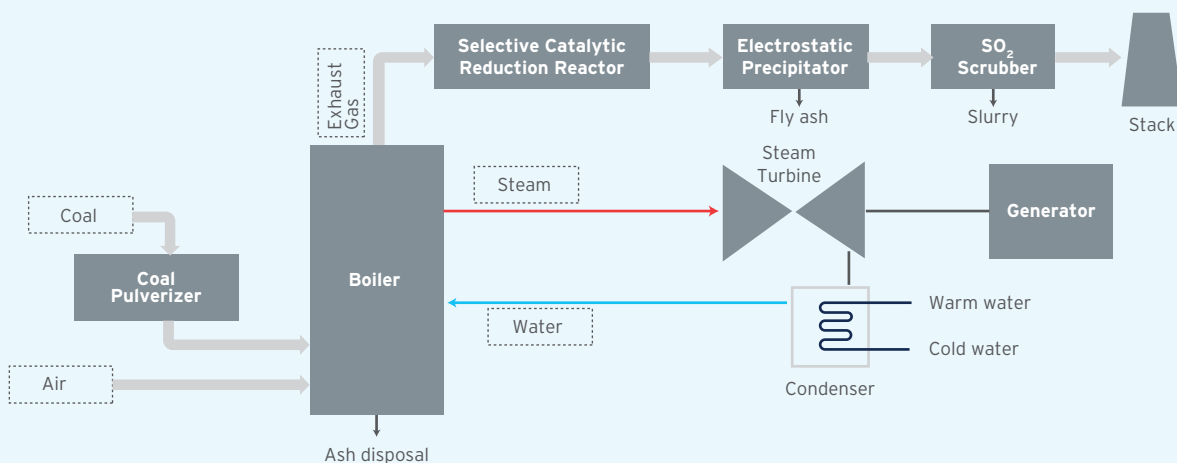



Coal is received at the material handling yard and thereafter undergoes crushing and beneficiation to reduce the size/moisture/ash content, depending on the quality and size of the coal. The coal is then pulverized to coal fines that can be efficiently combusted in the boiler. This pulverized coal is mixed with air in the combustion chamber and controlled combustion is performed to produce heat energy. After the completion of the combustion process, the ash residue is collected at the bottom of the combustion chamber and is ejected as slag. The combustion chamber and boiler are efficiently integrated to minimize heat loss. The boiler has tubes present in it, which carry water. The heat energy released from combustion is absorbed by this water to turn into steam. This steam is passed through steam turbines. A series of high pressure (HP), intermediate pressure (IP) and low-pressure (LP) turbines are present to extract the maximum heat energy from the steam. These steam turbines drive the generators to produce electricity.

The flue gas is subjected to cleaning operations such as a selective catalytic reduction reactor (for NO<sub>x</sub>), electrostatic precipitator (for fly ash), and sulfur dioxide scrubber. After the flue gas meets the emission norms, it is emitted through flue gas stacks in the atmosphere. The only source of Scope 1 emissions is the flue gas stack. The rest of the operations incur Scope 2 emissions. Typical flue gas characteristics of a coal-fired thermal power plant are given in Table 2-1.

**Table 2-1: Flue Gas Characteristics of Coal-Fired Thermal Power Plants**

Component	Unit	Value
Temperature	°C	150-180
Pressure	atm	1
<b>Composition</b>		
CO <sub>2</sub>	vol%	12-14
H <sub>2</sub> O	vol%	8-10
O <sub>2</sub>	vol%	3-5
N <sub>2</sub>	vol%	72-77
SO <sub>2</sub>	ppmv	120-200
NO <sub>x</sub>	ppmv	150-250

## b) Natural Gas-fired Thermal Power Plant

Natural gas is a relatively cleaner fuel compared to coal and has very few impurities. Gas turbine technology is used to generate power from natural gas (Figure 2-7). Air is sent to the compressor, where it gets pressurized. This high-pressure air is sent to the combustion chamber and mixed with the fuel (natural gas). This mixture is ignited and the combustion results in hot flue gases. This flue gas stream then drives the turbine which is connected with the generator that uses the kinetic energy to generate electricity. The turbine and compressor are on the same shaft; thus, the compressor energy requirement also decreases.

The flue gases released are still at a very high temperature, indicating that more heat energy can be extracted from this stream. Thus, the flue gases are further fed to a heat recovery steam generator. Here, the heat energy of flue gases is used to generate steam from water which drives the steam turbine to generate additional power. This increases the energy conversion efficiency of plants. This type of plant is termed as a "combined cycle power plant". Figure 2-8 illustrates a schematic of a natural gas combined cycle (NGCC) power plant.

**Figure 2-7: Schematic Representation of Gas Turbine [Reproduced from (Breeze, 2019)]**

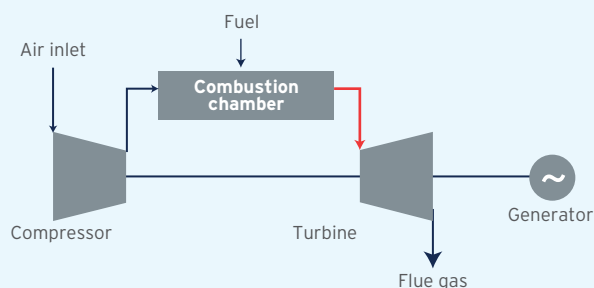

**Figure 2-8: NGCC Power Plant Schematic Diagram [Reproduced from (Breeze, 2019)]**

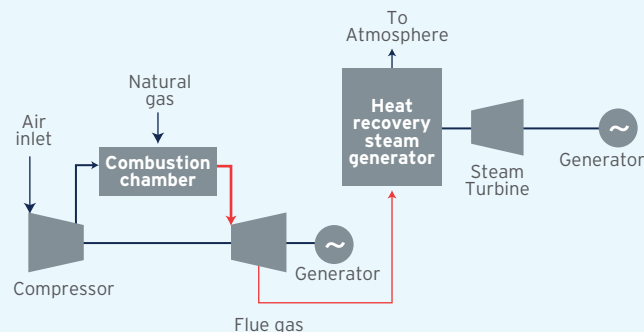

The Scope 1 emissions are from the flue gas emitted to the atmosphere at the end of the process. The rest of the processes may involve Scope 2 emissions. Typical flue gas characteristics of natural gas combined cycle (NGCC) power plants are mentioned in Table 2-2.

**Table 2-2: Flue Gas Characteristics of Coal-Fired Thermal Power Plants**

Component	Unit	Value
Temperature	°C	100-150
Pressure	atm	1
Composition		
CO <sub>2</sub>	vol%	4-10 vol%
H <sub>2</sub> O	vol%	10-12 vol%
O <sub>2</sub>	vol%	8-10 vol%
N <sub>2</sub>	vol%	70-75 vol%
SO <sub>2</sub>	ppmv	Low
NOx	ppmv	Low

#### 2.2.1.4 CO<sub>2</sub> Emissions from the Power Industry

Globally the power sector accounts for the largest share of GHG emissions; the sector accounted for 42% of the total anthropogenic CO<sub>2</sub> emissions of the world in 2019 (IEA). In India, the power sector is responsible for 51% of total anthropogenic emissions (IEA). Thus, decarbonization of the power sector is critical to lowering total anthropogenic CO<sub>2</sub> emissions in India.

For the analysis of CO<sub>2</sub> emissions from the power sector, merchant power plants (owned by Central PSUs, State PSUs, JVs as well as private generators), along with captive power plants of the aluminium industry, have been considered. The CO<sub>2</sub> emission intensity database is provided by Central Electricity Authority (CEA) (CEA, 2020). The analysis was carried out for the financial year FY 2021-22, using the actual plant load factor of 57.02% (till 30 November 2021) to calculate the emission figures. A total of 271 power plants were analyzed. These plants have been analyzed based on their district, state and the prime mover used. The prime mover can be of 3 types: steam, gas, and diesel.

Coal and lignite based power plants use steam as the prime mover, but have different CO<sub>2</sub> emission intensities. An overall analysis is provided in Table 2-3. A minimum capturable CO<sub>2</sub> of 2 mtpa from a single source is envisaged to be economically feasible. For district-level analysis, districts with CO<sub>2</sub> emissions (power-related) greater than 20 mtpa have been considered.

**Table 2-3: Overall Analysis of CO<sub>2</sub> Emissions from the Power Sector in India**

Component	Value
Total number of power plants	271
No. of days of operation	330
Total emissions (mtpa) (PLF = 100%)	1760.8
Total emissions (mtpa) (PLF = 57.02%)	1,004
Total number of power plants with greater than 2 mtpa CO <sub>2</sub> emissions	159
Total number of districts with greater than 20 mtpa CO <sub>2</sub> emissions	10

#### CO<sub>2</sub> Emissions by Prime Mover

Power plants can be categorized into three types based on their prime mover, i.e. steam, gas, and diesel. Coal and lignite have the largest installed generation capacity in India, followed by natural gas and a small share for diesel. The contribution of each prime mover to the total CO<sub>2</sub> emissions from the power sector is illustrated in Figure 2-9.

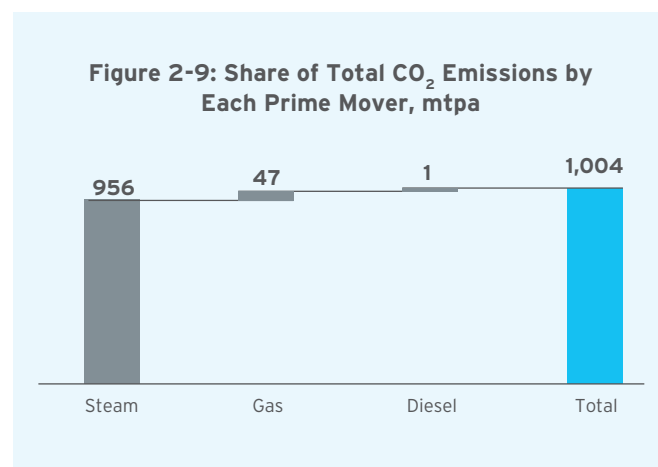



Considering a minimum of 2 mtpa of capturable CO<sub>2</sub> from each plant, the above analysis is presented in Table 2-4.

**Table 2-4: CO<sub>2</sub> Emissions by Prime Mover for Plants with Minimum 2 mtpa Capturable CO<sub>2</sub>**

Prime Mover	No. of plants	Total CO <sub>2</sub> Emissions (mtpa)
Steam	155	917
Gas	4	11
Diesel	-	-
<b>Total</b>	<b>159</b>	<b>928</b>

Power plants with steam as the prime mover (both coal and lignite-fired) have the highest emissions; thus, CCUS projects need to be focused on these plants. The emissions from power plants with gas and diesel as the prime mover are significantly less and these plants can be included in the scope of CCUS at a later stage.

### CO<sub>2</sub> Emission by Region

In order to form a CCUS cluster, it is important to perform a region-wise emission analysis of power plants. The aim of the analysis is to identify the hotspots/clusters of emissions that can be targeted for CCUS. This would also help define the policy/credit system suitable for that region. The region-wise analysis can be carried out based on

- Districts
- States

The district-wise analysis yields information about the highest emitting districts, which can be the focus of initial CCUS projects in the Indian power sector. A centralized CO<sub>2</sub> processing unit can be planned for these districts, which will make the capture and transportation of CO<sub>2</sub> more techno-economically feasible. Only power plants with minimum CO<sub>2</sub> emissions of 2 mtpa have been considered in the analysis. For district-wise analysis, districts that emit more than 20 mtpa CO<sub>2</sub> have been considered. Information about these districts is provided in Table 2-5.

**Table 2-5: District-wise CO<sub>2</sub> Emission Analysis**

District	Number of plants	CO <sub>2</sub> Emissions (mtpa)
Singrauli	5	52
Sonbhadra	6	49
Kutch	2	34
Korba	6	34
Nagpur	4	28
Angul	4	27
Raigarh	5	27
Cuddalore	5	25
Janjgir-Champa	4	24
Chandrapur	4	21
<b>Total</b>	<b>45</b>	<b>321</b>

These districts account for about 32% of the total CO<sub>2</sub> emissions by the power sector in India. Implementation of CCUS in these districts will lead to significant CO<sub>2</sub> abatement. The state-wise analysis (Figure 2-10) identifies the states to be prioritized for CCUS implementation in India. The top 10 states contribute 75% of the total CO<sub>2</sub> emission by the power sector. Thus, incentivizing the implementation of CCUS clusters through various policy mechanisms suited to these states will help in quicker adoption & implementation of CCUS and lead to significant decarbonization of India's power sector.

**Figure 2-10: State-Wise Analysis of CO<sub>2</sub> Emissions (mtpa)**

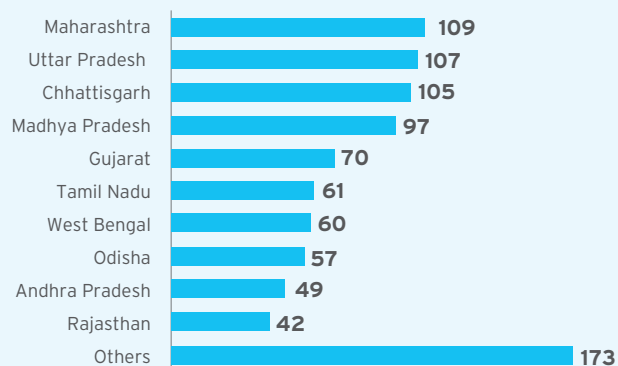

### 2.2.1.5 CO<sub>2</sub> Emission Projections for the Power sector

According to CEA and IEEFA projections (Gujarat's Electricity Sector Transformation, 2019), the installed capacity in India is expected to more than double and reach around 820 GW by 2030 from the existing capacity of around 400 GW. The projection of the generation capacity by type is given in Table 2-6. Thermal power (coal + gas) capacity in India is expected to reach 290 GW by 2030. Although the share of thermal capacity is expected to drop from the present 60% to 36% in 2030, thermal power generation is expected to still account for 56% of the total electricity generation in India.

The drop in the share of installed generation capacity of thermal power plants is due to the significant increase in renewable energy capacity. However, anthropogenic CO<sub>2</sub> emissions from the power sector will still contribute to the majority of CO<sub>2</sub> emissions in India. The CO<sub>2</sub> intensity will also increase in the future with improved plant performance and PLF, the retirement of old facilities and the operation of super-critical or ultra super-critical units. Based on the contribution of thermal power plants and their CO<sub>2</sub> emission intensity, the total scope 1 emissions from thermal power plants is estimated to be around 1200 mtpa in 2030 (Table 2-6).

**Table 2-6: Energy & CO<sub>2</sub> Volume Projections for FY 2029-30**

Component	Present (2022)	FY 2029-30
<b>Installed Capacity, GW</b>		
Thermal	236 (60%)	292 (36%)
Hydro	46 (12%)	66 (8%)
Nuclear	7 (2%)	19 (2%)
RES	106 (26%)	440 (54%)
<b>Total</b>	<b>395</b>	<b>817</b>
<b>Gross Generation, BU</b>		
Thermal	913 (74%)	1393 (56%)
Hydro	134 (11%)	206 (8%)
Nuclear	39 (3%)	113 (5%)
RES	141 (11%)	804 (31%)
<b>Total</b>	<b>1,227</b>	<b>2,516</b>
Wtd. avg. CO <sub>2</sub> emission intensity, kg/kWh	1.09	0.868
<b>Total CO<sub>2</sub> emissions from thermal power plant</b>	<b>1,004</b>	<b>1,210</b>

## 2.2.2 CO<sub>2</sub> Emissions: Indian Steel Industry

### 2.2.2.1 Introduction

The Indian iron and steel industry is primarily based on the processing of virgin materials like iron ore, coal, etc. and is hence an energy-intensive sector, responsible for about 10% of the total CO<sub>2</sub> emissions in India. Production of iron largely through the blast furnace and coal-based DR route, combined with low availability of scrap in India, make the Indian steel industry a coal-intensive sector, leading to an estimated 240 mtpa of direct CO<sub>2</sub> emissions for supporting steel production of 109 mt in 2019. The

crude steel capacity and production for the last five years are shown in Figure 2-11. Steel production has grown at a compounded annual growth rate (CAGR) of 6% from FY 2016-17, till the COVID-19 hit both demand and production in FY 2020-21. However, steel demand and production has sharply bounced back in FY 2021-22 and a long term growth rate of 6% is achievable for India. Steel demand and production in India is expected to reach about 190 - 200 mtpa by the year 2030. The share of different steel making routes is unlikely to significantly change till 2030; based on the same, CO<sub>2</sub> emission from the steel sector is expected to reach 450 mtpa by 2030.

**Figure 2-11: Crude Steel Capacity & Production in Last 5 Years (in mtpa)**

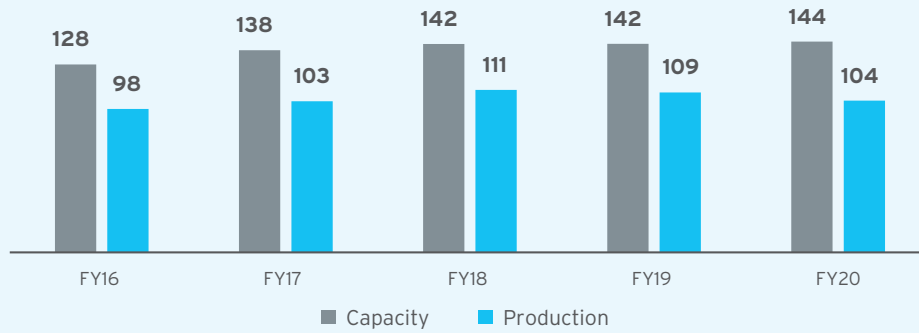

Source: JPC

**2.2.2.2 Routes of Iron and Steelmaking in India**

There are three steelmaking routes prevalent in India (i) Basic Oxygen Furnace (BOF); ii) Electric Arc

Furnace (EAF), and (iii) Induction Furnace (IF). The contribution of different routes for the last five years is shown in Figure 2-12.

**Figure 2-12: Process Route Wise Steel Production and Contribution (in mtpa)**

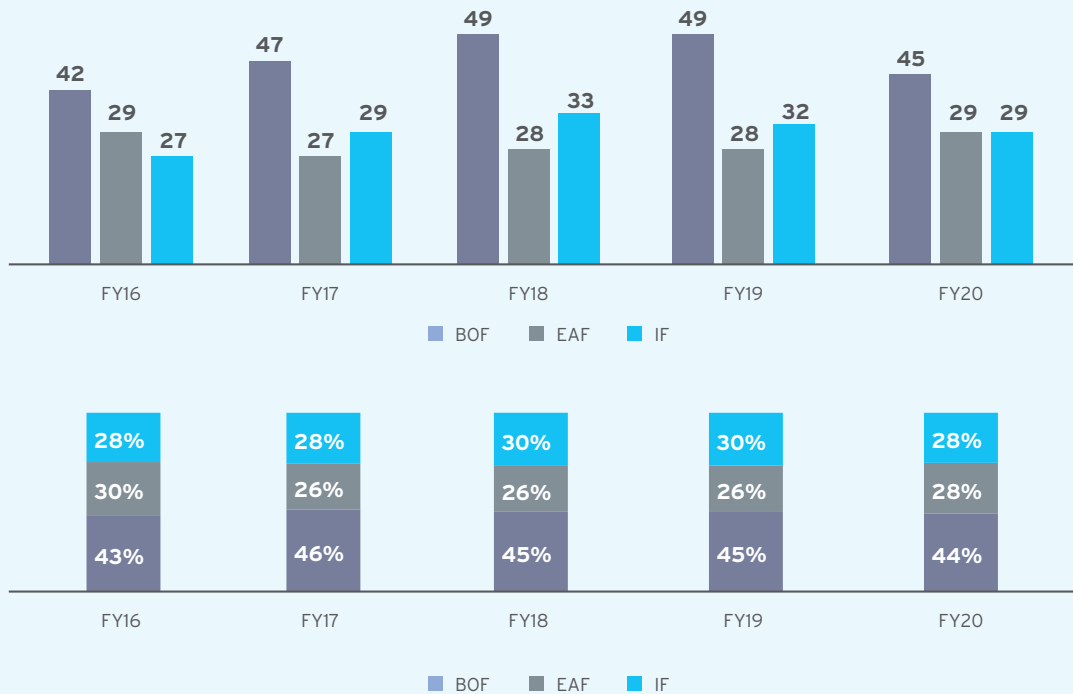

Source: JPC

Almost all the large integrated steel plants have adopted the BOF route production because of its robustness, scale, and reliability. The BOF route uses 85-95% hot metal in the charge mix, produced from Blast Furnace/COREX/FINEX. On the other hand, the induction furnace route is 100% solid-charge based, and primarily uses DRI, pig iron, and scrap. IF-based production is electric-energy intensive and suitable for small-scale production. The EAF route is flexible and ideal for mid-sized plants (0.5 to 1 mtpa) and can be designed to take more than 80% hot metal, whereas the conventional EAF design is based on 100% solid charge. Due to the operational robustness & flexibility and superior techno-economics of BFs, most EAFs in India use a certain percentage of hot metal in the charge mix.

In the BF route, iron is extracted as liquid hot metal from sinter, pellet, and iron ore lumps, with coke and pulverized coal being used as reductants. In smelting reduction processes like FINEX & COREX, iron ore fines and coal are used to produce hot metal. The alternative iron-making routes encompass the coal-based and gas-based DR processes that produce solid iron known as DRI or sponge iron, which is subsequently melted and refined in the EAF/IF process. The unit processes are described below, including the perspective of direct CO<sub>2</sub> emissions in each process. An illustration of the various process routes in India is given in Figure 2-13.

Figure 2-13: Various Iron and Steel Making Routes in India

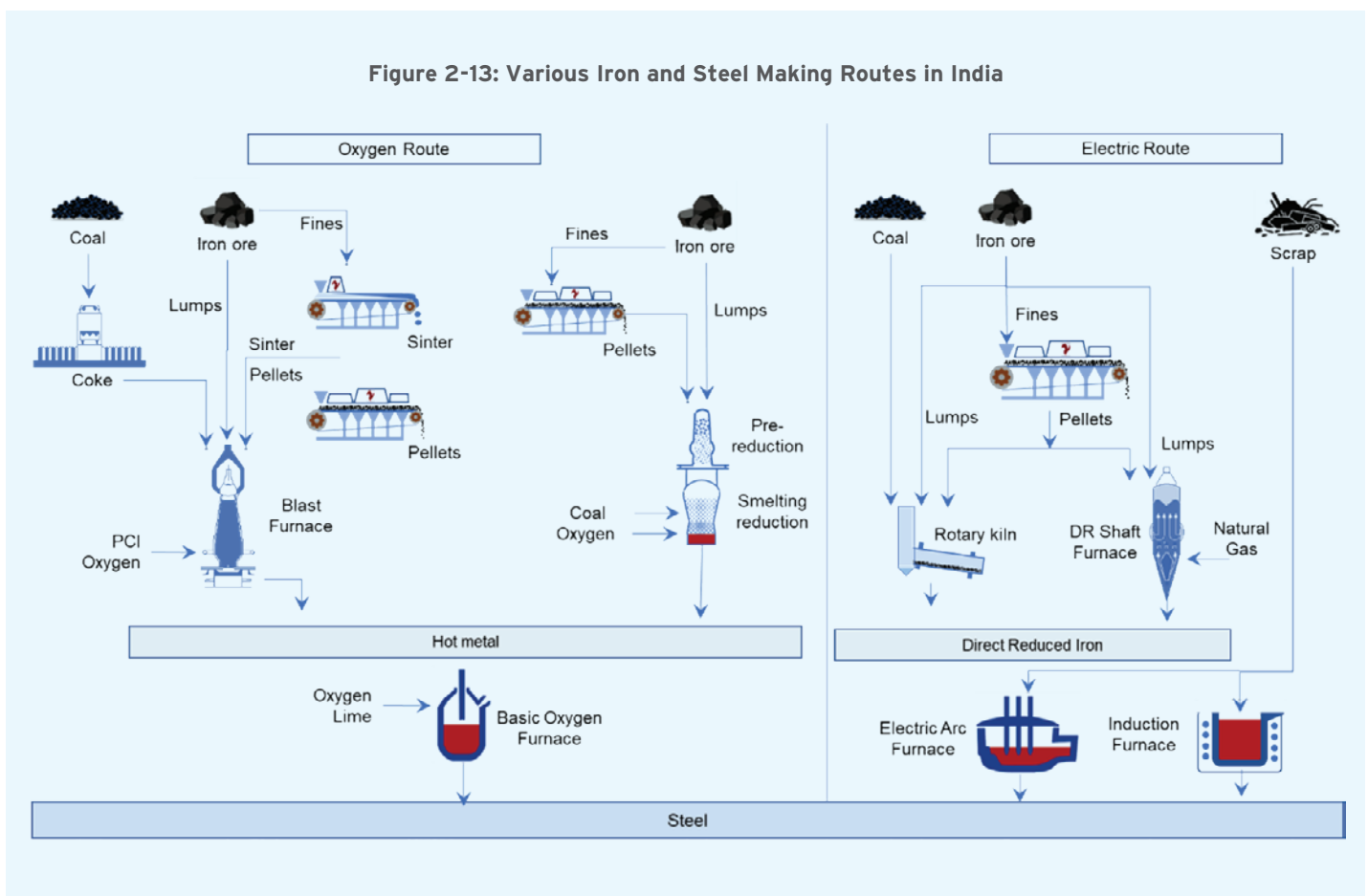

### 2.2.2.3 Brief Description of Unit Processes



#### Coke making

Metallurgical coke is produced at scale (typically 0.5 mtpa and higher) in by-product recovery and non-recovery coke ovens. By product recovery coke oven battery is the preferred choice for the ISPs, while non-recovery coke oven is generally adopted by merchant coke producers. Coking is the process of heating coking coal at a high temperature in the absence of air to expel its volatile matter and obtain a strong porous coke. Metallurgical or coking coal softens, swells, and hardens with sufficient porosity and strength during the coking process. The pulverized coal blend is charged into the ovens and heated at 1100 °C for about 16-20 hours (for by-product ovens) or about 45-50 hours (for non-recovery ovens). The hot coke is pushed out of the ovens into a quenching car that is taken to quenching stations for cooling before being conveyed to the blast furnace. In by-product recovery ovens, the gas coming out from the coking chamber is processed in a chemical plant to produce clean coke oven gas (COG) and several by-products such as tar, ammonium sulphate, phenol, naphthalene and sulphur. Clean coke oven gas, with high calorific value, is used as a fuel source in downstream facilities after suitably mixing with other fuel gases. In the non-recovery ovens, all the gas emissions are utilized to produce steam, which is subsequently used in power generation. The total amount of CO<sub>2</sub> released from the coke oven flue stack is estimated to be about 0.3 tonne per tonne of finished steel.



#### Sintering

Sintering is a process of agglomeration of ore fines along with fluxes to improve the reducibility of the ore material and decrease coke consumption in the blast furnace. A sintering machine consists of a travelling grate with air suction from its bottom all along its length. A mixture of ore fines, fluxes, and coke breeze is charged on the travelling grate and is ignited on the surface by a hood near the beginning of the strand. Due to the air suction and coke breeze, the ignition front travels across the depth of the bed, providing the heat for sintering. Sintering occurs at a temperature of about 1300 °C which results in melting particles at the surface and agglomeration at the grain

level. At the end of the strand, the hot sinter is passed through a roll crusher, screens, and coolers. The off-gas from a sinter plant is released into the atmosphere after recovery of the sensible heat. The combustion of coke breeze and fuel gases in the process contributes to about 0.43 tonne of CO<sub>2</sub> per tonne of finished steel.



#### Pelletization

Pelletization is the process of agglomerating very fine particles of iron ore with fluxes, without any incipient melting. The pelletization process consists of three main steps: mixing of the feed particles with a binder, making of raw pellet balls in a drum or disc pelletizer, and heat hardening of raw pellets in a travelling grate-rotary kiln-train at around 1300 °C. Since the bonding is established due to diffusion without any melting, the pelletization process consumes significantly less energy and emits significantly lower CO<sub>2</sub> vis-à-vis sintering.



#### Ironmaking

Iron making or production of hot metal in India is primarily through the Blast Furnace (BF) route; additionally, there are a few COREX plants in India. In a BF, iron ore lumps and sinter or pellets is charged from the top of the furnace along with coke, limestone and dolomite. A hot blast of preheated air with a temperature of over 900 °C is blown through the tuyeres from the bottom of the BF, which burns the coke to produce heat and carbon monoxide (CO). The coke reduces the iron oxide to metallic iron, while producing BF gas. The fluxes help the separation of gangue from the ore, thus forming slag. A high temperature of 1400 °C in the hearth of the furnace enables the tapping of hot metal and slag in the liquid form. The top gas (BF gas) is collected, cleaned and cooled. Despite its lower CV, the large volume of BFG generation makes it an important fuel that is used in the various furnaces of the steel plant, that require an external heat source. BF gas is also used in power production after suitably mixing with other gases like COG and BOFG. The direct CO<sub>2</sub> emission from the stove flue stack accounts for 0.4 tonne of CO<sub>2</sub> per tonne of finished steel. The CO<sub>2</sub> and equivalent CO<sub>2</sub> from the CO in BF gas are emitted in the units which consume the BF gas.



### Basic Oxygen Steelmaking (BOF)

This is a refining process whereby oxygen is blown through hot metal in a converter to remove impurities like carbon, silicon and phosphorous to produce liquid steel. The oxygen blowing results in the formation of an emulsion of gas, molten metal and fluxes, leading to high reaction rates and making this a rapid process. The oxidized impurities and fluxes form a basic slag that is tapped at the end, separate from the tapping of steel. To consume the heat released from the oxidation reactions, scrap or iron ore is added as coolant. The oxidation of carbon releases CO and CO<sub>2</sub>. Due to its high CO concentration, the cooled and cleaned BOF off-gas is collected for further use. Liquid steel from the BOF is further refined in secondary steelmaking units like ladle furnace, VD, VOD, RH-OB before being sent to the casters for billet/bloom/slab production.



### Rolling Mills

Semis from the steel melt shop are rolled for production of final products like rebars, wire rods, structural sections and hot rolled coils. Cold billets/slabs are charged to a reheating furnace,

fuelled by mixed gas, to reheat the semis to around 900-1000°C. The hot semis are passed through multiple rolling stands before being cooled down in a cooling station. The Scope 1 emissions are limited to the reheating furnace flue gas only. It is estimated that 0.17 tonne of CO<sub>2</sub> per tonne of finished steel will be emitted from the rolling mill.



### Calcining Plant

For the refining of hot metal, calcined lime and dolo are required in the SMS operations. For the production of lime and dolo, raw limestone/dolomite is charged into a kiln (vertical shaft or horizontal kiln), where calcination occurs at a temperature of around 1000°C. Heat is supplied by in-plant fuel gas or purchased fuel. CO<sub>2</sub> is generated from the combustion of fuel as well as from the decomposition of CaCO<sub>3</sub>. The calcining process contributes around 0.23 tonne of CO<sub>2</sub> per tonne of finished steel.

Total CO<sub>2</sub> emission in a typical BF-BOF based ISP is estimated at 2.15 tonne per tonne of finished steel (Figure 2-14). The CO<sub>2</sub> concentration at each unit is based on the typical specific fuel consumption and fuel blend.

Figure 2-14: CO<sub>2</sub> Emission (in tonne) per tonne of Finished Steel BF-BOF route

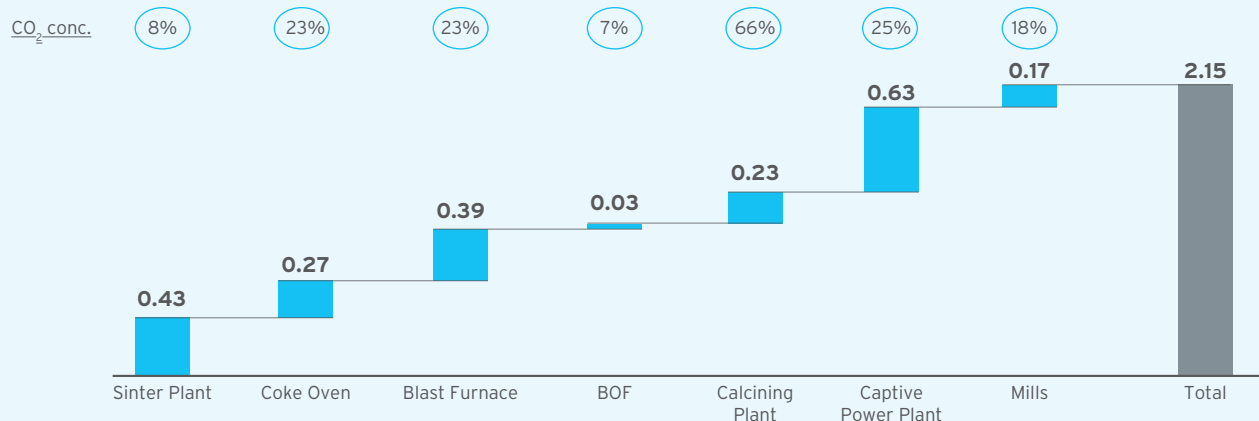



Given the high CO<sub>2</sub> intensity of the BF-BOF route, CCUS is critical to ensuring the long-term sustainability of the Indian steel sector. CCUS can also enable the scalable and profitable conversion of waste gases from Blast Furnace, Coke Oven and Basic Oxygen Furnaces of Integrated Steel Plants to blue hydrogen at a cash cost of less than Rs. 100 per kg. Blue hydrogen can be used within the steel plant as a source of clean energy or for producing clean DRI. The blue hydrogen can also be sold to external consumers, thus propelling the clean hydrogen economy in India.



#### Coal Based DR Processes (Coal DR)

This route of iron making uses non-coking coal as a reductant to obtain the solid product of reduced iron, known as DRI or sponge iron. DRI is further melted and refined in the EAF to produce steel. Rotary kiln and rotary hearths are the two major coal DR processes widely used in India. In the rotary kiln process, sized lump ore or pellets, coal, limestone and dolomite are charged from the feeding end of a rotating kiln, while air and the heating source are provided at the discharge end of the kiln. The generation of CO enables the complete reduction of iron oxide by the discharge end, which is later magnetically separated out from other solid residues. The limestone and dolomite calcine, releasing CO<sub>2</sub> and forming lime and magnesia that act as desulphurizing agents. A temperature of around 1000 °C is maintained to enable faster reactions as well as to minimize any fusion of reaction products. The sensible heat of off-gas containing N<sub>2</sub> & CO<sub>2</sub> is used for the production of power, through utilization in a waste heat recovery boiler. Since the coal DR processes involves solid-solid reactions, it is not as efficient as the countercurrent gas-based blast furnace process. This results in higher coal consumption and higher CO<sub>2</sub> emission intensity.



#### Gas Based DR Processes (Gas DR)

Natural gas based DR production is a continuous countercurrent moving bed process employing vertical shaft furnaces to produce DRI from lump ore or pellet charge and using reformed

natural gas as the reductant. The principle of iron ore reduction is similar to the blast furnace, except that there is no fusion and melting of solid products, thereby using less energy and emitting less CO<sub>2</sub> directly. Iron ore pellets are charged from the top of the shaft while reformed natural gas is heated and injected from the bottom of the reduction zone. The gas leaving the shaft from the top (the top gas) has significant reducing power and calorific value due to its unutilized CO and H<sub>2</sub> and is therefore recycled back to the DR shaft after bringing down the CO<sub>2</sub> and N<sub>2</sub> fractions. The N<sub>2</sub> is lowered by splitting a portion of the top gas to be use as a fuel for heating. The CO<sub>2</sub> in the remaining stream is lowered either by CO<sub>2</sub> separation or using the gas for dry reforming of natural gas.

Midrex and Hyl are two the major gas DR processes widely employed across the globe, with similar operating principles. The Midrex process operates at low pressures (< 2 bar) and uses dry reforming of natural gas. The Hyl process operates at high pressure (6 to 8 bar) and hence employs smaller shafts. Conventional Hyl uses steam for reforming natural gas, while the Hyl-ZR process uses in situ reforming and therefore the separated CO<sub>2</sub> during the top gas cleaning is available for utilization or sequestration.

#### 2.2.2.4 CO<sub>2</sub> Emissions from the Steel Industry

Based on the emission intensities of different processes (Table 2-7) and production data for FY 2019-20, the total volume of CO<sub>2</sub> emission from the three routes is estimated to be 240 mtpa. Based on the current momentum in steel demand, it is reasonable to consider that the steel production will reach 190-200 mtpa by 2030 with demand growing at 6% CAGR. This is corroborated by the fact that in addition to the existing 144 mtpa of steel production capacity (FY 20-21), expansions of 63 mtpa BF-BOF based capacity have been announced by various major steel players in the country. The DRI production is expected to increase by 20% by 2030 to 41 mtpa, merely by the increase in capacity utilization, which is currently at a low level of 70%. The share of gas DR versus coal DR is expected to remain the same, i.e. 20-80%. Scrap usage is expected to rise to 60 mtpa in 2030 from 30 mtpa in FY 2019-20.

Based on these considerations, hot metal production is estimated to rise to 150 mtpa from 69 mtpa in FY 2019-20. Combining these estimates with the respective CO<sub>2</sub> emission intensities, it is estimated that the total CO<sub>2</sub> emission shall increase to 450 mtpa by 2030. It is reasonable to assume that the route-wise distribution of production will not change significantly. Accordingly, the projected CO<sub>2</sub> volumes along with the region-wise analysis are provided below.

**Table 2-7: CO<sub>2</sub> Direct Emission Intensities for Various Iron Making Routes**

Product	BF-BOF	Coal DR-EAF/IF	Gas DR-EAF
t CO <sub>2</sub> /t product	1.8 - 2.2	2.6 - 3.0	0.6 - 0.8

In 2017, the Ministry of Steel published the National Steel Policy for India, which projected a crude steel capacity of 300 mtpa and crude steel production of 255 mtpa by the year 2030. The National Steel Policy is aspirational and provides an upper bound on the likely growth of the domestic steel sector. In case the targets and goals of the National Steel Policy are realized, it will lead to much higher CO<sub>2</sub> emissions of about 560 mtpa from the steel sector, as shown in Figure 2-15.

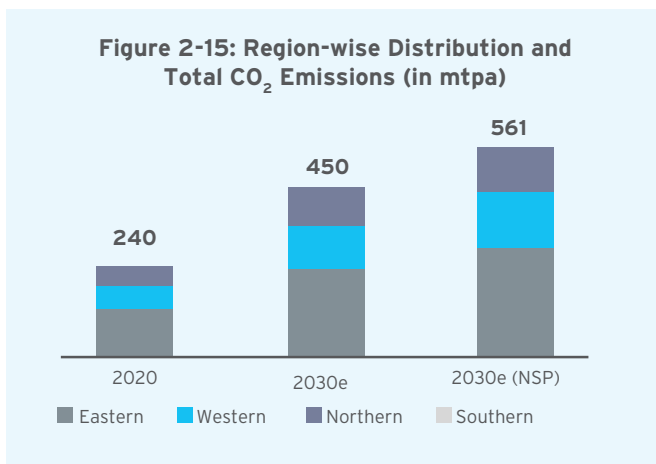

### 2.2.3 CO<sub>2</sub> Emissions: Indian Cement Industry

#### 2.2.3.1 Introduction

India is the second-largest cement producer in the world after China. Over the last five years, cement production has grown from 274 mtpa (FY 2015-16) to 381 mtpa (FY 2021-22) at a CAGR of 6% (Figure 2-16). Cement demand and production in FY 2020-21 was impacted by COVID-19, and has recovered in the subsequent year.

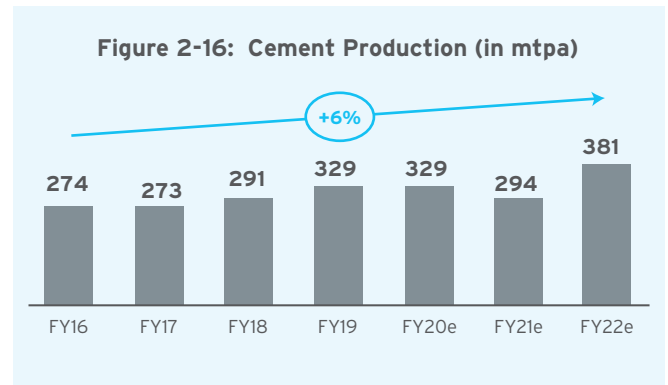

India's current cement production capacity is about 550 mtpa, implying capacity utilization of about 50% only. While India accounts for 8% of global cement capacity, India's per capita cement consumption is only 235 kg, and significantly low compared to the world average of 500 kg per capita, and China's per capita consumption of around 1700 kg per capita. It is expected that domestic demand, capacity utilization and per capita cement consumption will increase in the next decade, driven by robust demand from rapid industrialization and urbanization, as well as the Central Government's continued focus on highway expansions, investment in smart cities, Pradhan Mantri Awas Yojana (PMAY), as well as several state-level schemes.

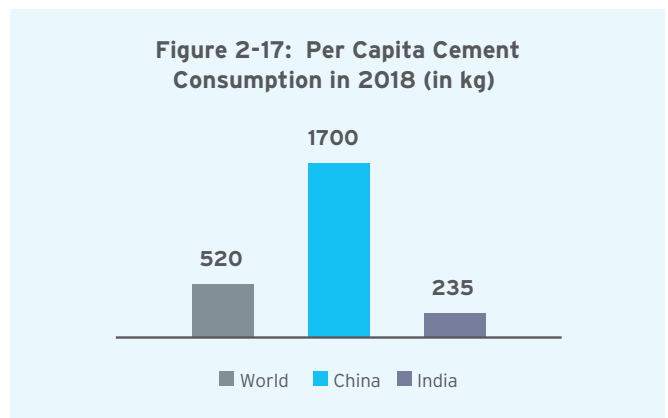

#### 2.2.3.2 Cement Plant Production and Capacity

Limestone is the major feedstock in cement production. Hence most cement plants are built either close to captive limestone quarries or are well connected with limestone quarries. Therefore clinker based cement plants are concentrated in South and North India. The market for slag/fly ash-based cement has also evolved in the last few years, with blast furnace slag/fly ash-based cement plants expanding in Eastern India. The region-wise cement production is shown in Figure 2-18 (Source: IBEF.org).

Figure 2-18: Cement Production (in mtpa)

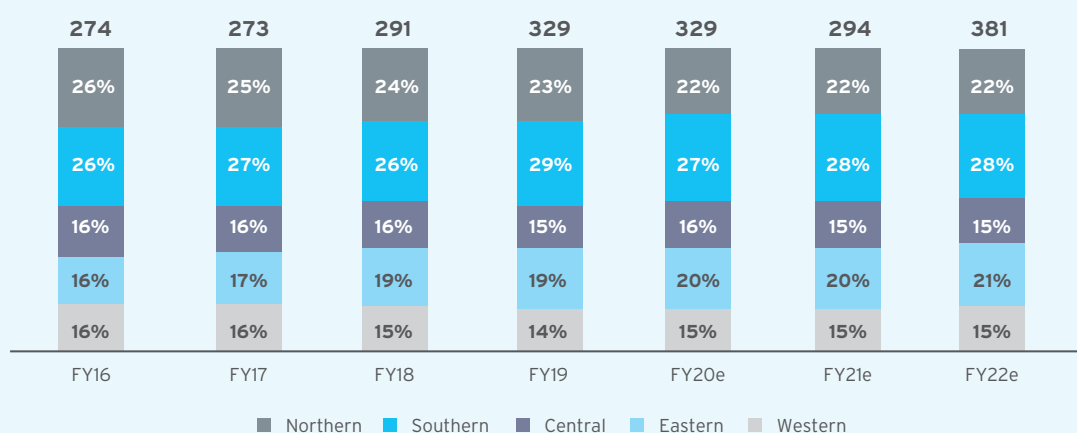

Cement production in India is dominated by private players. Almost 98% of the cement capacity belongs to private players like UltraTech, Shree Cements, Ambuja, ACC, Dalmia Cement etc. The cement market is also oligopolistic and the top 10 companies account for over 60% of the total capacity. The cement capacity of major players is given in Table 2-8 (Source: Indian Minerals Yearbook 2019 published by the Government of India).

The state-wise cement capacity is given in Table 2-9 (source: Indian Minerals Yearbook 2019 published by Government of India). The top five states i.e., Rajasthan, Andhra Pradesh, Karnataka, Tamil Nadu, and Gujarat, account for almost 50% of the total capacity. Given the proximity to limestone quarries, the majority of future expansions are also planned in these states only.

Table 2-8: Major Players of Cement Industry and Capacity (in mtpa)

Company Name	Capacity
Ultratech	125
Shree Cement	41
Ambuja	35
ACC	34
Dalmia	21
ICL	20
Jaypee Cement	17
Birla	15
Ramco	15
JK Lakshmi	15
Chettinad	14
Nirma	14
JSW	11
JK Cement	11
Kesoram Industries	11



Table 2-9: State-wise Cement Capacity

State	No. of Plants	Capacity (mtpa)	% of total capacity
Rajasthan	24	87	15.7%
Andhra Pradesh	26	63	11.3%
Karnataka	18	49	8.9%
Tamil Nadu	22	42	7.6%
Gujarat	17	41	7.5%
Madhya Pradesh	13	39	7.0%
Telangana	18	34	6.2%
Maharashtra	13	32	5.8%
Chhattisgarh	13	31	5.6%
Uttar Pradesh	14	24	4.3%
West Bengal	16	22	4.0%
Himachal Pradesh	9	16	2.9%
Odisha	5	13	2.4%
Jharkhand	6	13	2.3%
Bihar	6	11	1.9%
Meghalaya	10	9	1.7%
Haryana	5	7	1.3%
Punjab	4	7	1.3%
Assam	6	5	0.9%
Uttarakhand	3	4	0.7%
Andaman Nicobar	1	2	0.3%
Kerala	2	1	0.2%
Jammu and Kashmir	3	1	0.1%
Goa	1	0.2	0.0%
<b>Total</b>	<b>255</b>	<b>554</b>	<b>100%</b>

The district-wise distribution of cement plants has also been analyzed to understand the clusters of cement plant units. The top 20 districts/clusters

contribute to almost 50% of the total capacity (Table 2-10) (Source: Indian Minerals Yearbook 2019 published by Government of India).

**Table 2-10: Top 20 Districts/Clusters and Aggregate Capacity**

District name	State name	Capacity (mtpa)
Chittorgarh	Rajasthan	25
Gulbarga	Karnataka	23
Nalgonda	Telangana	21
Chandrapur	Maharashtra	20
Satna	Madhya Pradesh	20
Sirohi	Rajasthan	18
Raipur	Chhattisgarh	15
Anantapur	Andhra Pradesh	14
Pali	Rajasthan	13
Ariyalur	Tamil Nadu	13
Kurnool	Andhra Pradesh	12
Solan	Himachal Pradesh	12
Kadapa	Andhra Pradesh	11
Surat	Gujarat	10
Krishna	Andhra Pradesh	9
Jaintia Hills	Meghalaya	8
Amerli	Gujarat	8
Durg	Chhattisgarh	7
Junagadh	Gujarat	7
Bardhaman	West Bengal	7
Others		282
<b>Total</b>		<b>554</b>

Figure 2-19 below shows the top 10 cement clusters, based on their capacity, along with the names of the major producers in each cluster.

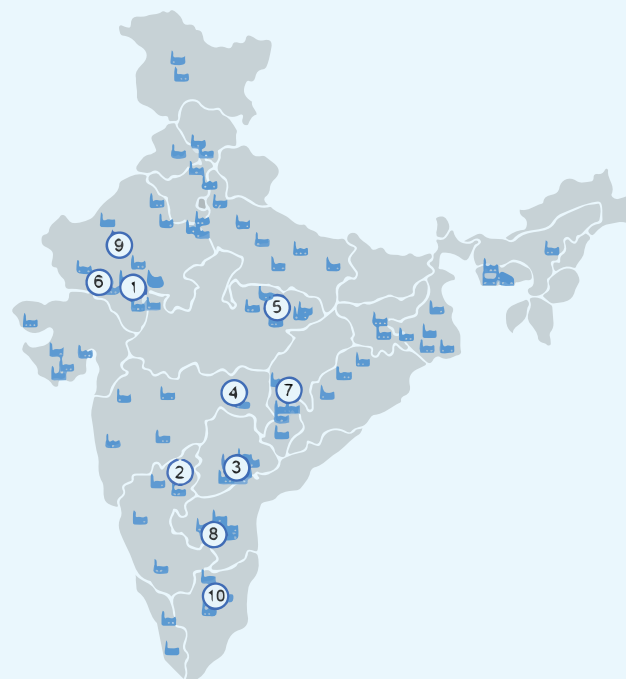
**Figure 2-19: Top 10 Cement Clusters Based on Cumulative Capacity****Clusters**

1	Chittorgarh, Rajasthan	25 mtpa 5 units	Wonder Cement, UltraTech, Nirma, Birla J.K Cement
2	Gulbarga, Karnataka	23 mtpa 5 units	UltraTech, Orient, Kesoram, Chettinad, Kalburgi
3	Nalgonda, Telangana	21 mtpa 12 units	My Home, Sagar, Zuari, ICL Penna, NCL, Deccan, etc.
4	Chandrapur, Maharashtra	20 mtpa 5 units	UltraTech, Ambuja, ACC, Dalmia
5	Satna, MP	20 mtpa 6 units	Prism Cement, UltraTech, Birla, KJS Cement, Jaypee Cement
6	Sirohi, Rajasthan	18 mtpa 2 units	UltraTech, JK Laxmi Cement
7	Raipur, Chhattisgarh	15 mtpa 6 units	Shree Cement, UltraTech, Nirma, Ambuja
8	Anantapur, AP	14 mtpa 4 units	Penna Cement, UltraTech, Sagar Cement
9	Pali, Rajasthan	13 mtpa 4 Units	Shree Cement, Nirma, Ambuja
10	Ariyalur, Tamil Nadu	13 mtpa 5 units	Chettinad cement, UltraTech, Dalmia, ICL

Analysis of the capacity distribution of individual cement plants reveals that the average capacity for the 255 cement plant units is 2.2 mtpa, whereas the capacity of most of the cement plants is between 1 to 3 mtpa.

**Table 2-11: Plant Capacity Distribution**

Capacity range	No of plants	% share
Less than 1.0 mtpa	63	25%
1.0 mtpa to 2.0 mtpa	85	33%
2.0 mtpa to 3.0 mtpa	55	22%
3.0 mtpa to 4.0 mtpa	29	11%
4.0 mtpa to 5.0 mtpa	11	4%
Greater than 5.0 mtpa	12	5%

### 2.2.3.3 Medium-term demand projection

The 10% decrease in cement demand in FY 2020-21 was temporal and due to the COVID-19. Cement demand is expected to grow going forward based on investments towards the infrastructure and housing sectors. It is envisaged that cement demand per capita will grow at around 6% CAGR to FY 2029-30. Thus, cement consumption per capita will reach 300 kg per capita by 2025 and 400 kg per capita by 2030. Thus cement demand is estimated to be around 440 mtpa by 2025 and about 650 mtpa by 2030, considering a population growth rate of 2% year-on-year and growth in cement consumption per capita at 6% per year.

**Figure 2-20: Cement Demand (in mtpa) and Per-capita Cement Consumption (in kg)**

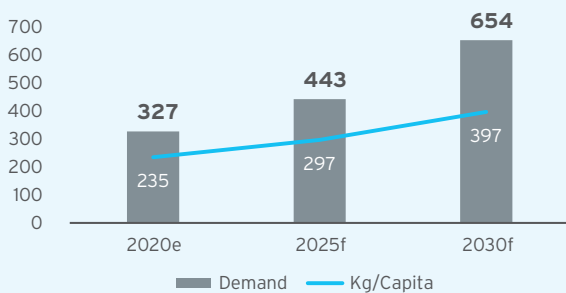

### 2.2.3.4 Typical Cement Manufacturing Process

Cement can be primarily categorized into three types, based on the clinker factor and usage of other ingredients i.e. fly ash or slag:

- Ordinary Portland Cement (OPC):** OPC is the most common type and is used widely in construction activities. The clinker factor is generally above 90% for OPC cement.
- Portland Pozzolana Cement (PPC):** Since fly ash is abundantly available at a low cost, the share of PPC-type cement has increased significantly over the last decade. The clinker factor is less than 60%. PPC is advantageous over OPC due to fineness, resistance to corrosiveness, and impermeability.
- Portland Slag Cement (PSC):** Blast furnace slag is predominantly used for the production of PSC. PSC is used in applications where concrete is exposed to rough weather like marine applications, high-rise buildings, etc.

The process route for different types of cement production is almost similar except for the final blending and grinding process steps. The dry-type technology predominant in the Indian cement industry is described below and depicted in Figure 2-21.



#### a) Mining

The manufacturing process starts from mining limestone, which is the primary ingredient for cement production. The limestone is primarily excavated from open cast mines after drilling and blasting and loaded onto dumpers. Dumpers transport the limestone and unload it into hoppers of limestone crushers. Other feed materials like sand, coal, pet coke etc., are sourced from outside.



#### b) Screening & Crushing

The raw materials are crushed in the primary crushing unit and then fed into the secondary crushing unit (along with the mixing of additives) to reduce the material size. The raw mix is conveyed to a circular storage unit called the raw mix storage. The mix is reclaimed from the stockpile by reclaimers and conveyed to the raw mix bin for grinding. High purity limestone and coal/pet coke generally have dedicated crushing and storing systems. However, other additives like sand are crushed in a common or shared crushing system.



**Figure 2-21: Typical Process Flow Diagram for Cement Making**

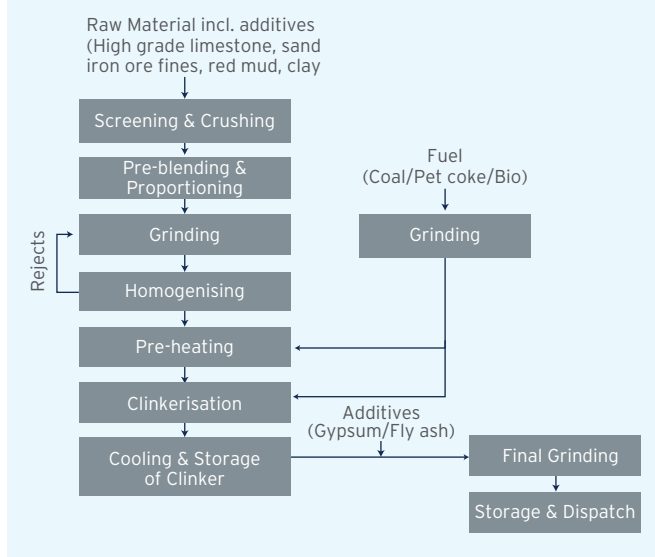

### c) Raw meal drying, grinding, and homogenization

Additives like iron ore/red mud are blended with limestone with the help of weigh feeder before drying and grinding to get the desired composition and properties. The raw mill consists of two chambers, namely a drying chamber and a grinding chamber, separated by a diaphragm. The hot flue gas from a preheater (preheater/kiln system) is used for drying. Then the materials enter the grinding chamber of the raw mills for fine grinding. The grinding mill can be of the conventional and simple ball mill type, or the advanced and complex Vertical Roller Mill (VRM) type. The hot gas, along with grinding materials, is fed to a separator that separates fine and coarse products. The coarse product is returned to the grinding unit. The hot gas and fine materials are passed through a cyclone unit to separate fine materials and gases. The fine material is collected from the multi-cyclone. The very fine materials carried away by flue gas to an electrostatic precipitator (ESP), where the finer particles are separated from gases. The ESP dust is collected from bag filters and fed into screw conveyors, and mixed with the fine material. Raw meal/kiln feed is stored in a blending silo for homogenization before being fed to the top of the preheater for pyro-processing.

### d) Clinkerisation

Cement clinker is made by pyro-processing the kiln feed in the preheater-kiln system. The preheater-kiln system consists of a multi-stage (generally more than five) cyclone preheater, combustion chamber, riser duct, rotary kiln, and grate cooler. In the preheater section, heat transfer depends on the number of stages of the preheater. Additionally, coal is also fired for additional heat requirements. The preheater helps in removing moisture from the feed, as well as raising the temperature of the feed through countercurrent heat transfer with hot flue gas.

The preheated kiln feed is partially calcined in a combustion chamber and riser duct and then completely calcined in a rotary kiln and heated to approximately 1400-1500 °C to form the clinker components. Coal is fed through a burner which is the primary source of heat for the calcination. However, alternative fuels like petcoke, biomass, and other solid waste are also used. Hot clinker is discharged to the grate cooler for cooling from 1350-1450 °C to around 1200 °C with atmospheric air. The cooled clinker is then conveyed to hoppers for clinker storage.

### e) Cement grinding and storage

Clinker and gypsum for OPC, fly ash for PPC, and slag for PSC is transferred from individual hoppers and fed to the cement mills. The mill discharge is fed to the screen, which separates fine and coarse products. The coarse product is returned to the mill inlet for regrinding, and the final product is stored in concrete silos.

### f) Packing

Cement is conveyed from silos to the automatic packers, where it is packed in 50 kg bags and dispatched to the market.

### 2.2.3.5 CO<sub>2</sub> Emissions from Cement Manufacturing

In 2018, cement production contributed about 12% or 264 mtpa of anthropogenic CO<sub>2</sub> emissions in India (source: IEA). The emissions will rise with the sustained increase in cement demand and production in the near future. CO<sub>2</sub> emissions vary widely from plant to plant depending on specific factors such as product type, plant efficiency, fuel usage, plant capacity etc.

Hence an average CO<sub>2</sub> emission per tonne of cement has been used to calculate the total CO<sub>2</sub> emissions at the current and project level of cement demand and production.

The Indian cement industry is focused on sustainability and environmental impact, vis-à-vis its peers. According to an April 2018 publication by CDP, a

UK-based organization, five out of the top ten global cement companies in terms of low carbon transitions are from India. Indian cement companies are ahead of the global average in terms of specific electrical and thermal energy consumption (Table 2-12). This is primarily due to fly ash/slag usage in the blend, efficient dry processes, and alternate fuel usage.

**Table 2-12: Consumption Parameters**

Particulars	Unit	Global Avg.	India Best	India Average
Specific Electrical Energy Consumption	kWh/tonne of cement	91	64	80
Specific Thermal Energy Consumption	GJ/tonne of clinker	3.5	2.83	3.1

Source: Cement Manufacturing Association

The average CO<sub>2</sub> emission intensity per tonne of cement was 576 kg in 2018. The Scope 1 and Scope 2 emissions are primarily from three sources:

- Emission from process calcination (CaCO<sub>3</sub> → CaO) accounts for 57-60% of total emissions
- Emission from process heating in terms of thermal energy usage contributes around 27-31%
- Emission from power usage for grinding, process fans, etc., accounts for 10-13%.
- Limestone mining also has a small contribution to the total CO<sub>2</sub> emission (limited to 1-2%).

A typical CO<sub>2</sub> cascade is shown in Figure 2-22.

The CO<sub>2</sub> emission intensity is expected to reduce to 500-520 kg per tonne with further improvement in the cement production process, through higher production of blended cement, using vertical roller mills, installing WHRB, etc. The total CO<sub>2</sub> emission from the cement sector has been estimated to reach 325 mtpa by the year 2030, considering 0.5 tonne of CO<sub>2</sub> emissions per tonne of cement.

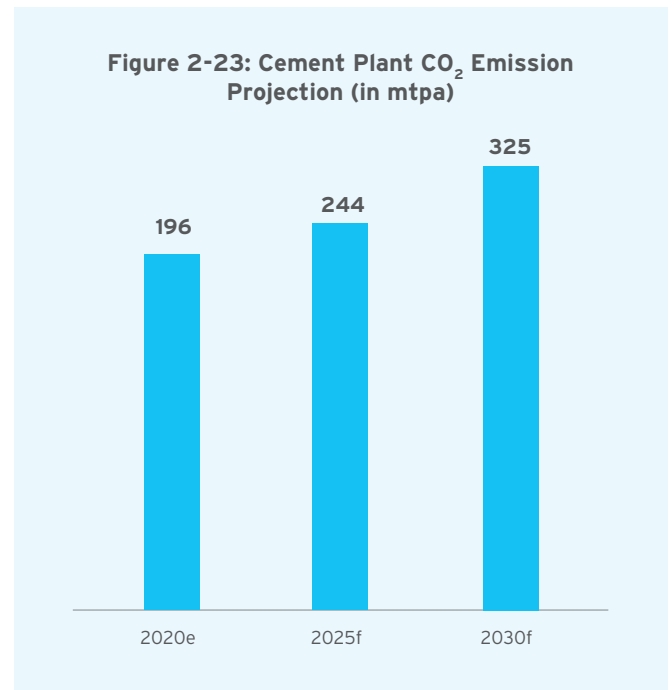
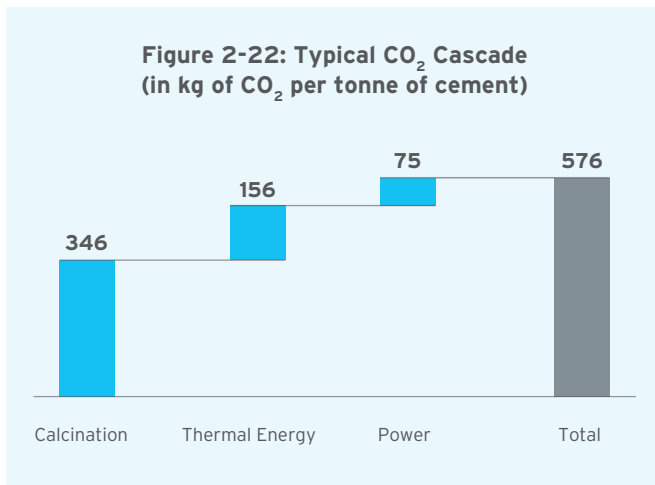

## 2.2.4 CO<sub>2</sub> Emissions: Indian Oil & Gas and Chemical Industry

### 2.2.4.1 Introduction

The chemical industry is another energy-intensive sector and produces materials used in multiple downstream sectors. The Indian chemical industry is ranked as the 6<sup>th</sup> largest in the world and the 3<sup>rd</sup> largest in Asia. India is one of the largest production hubs of chemicals and in the next 5-10 years the industry is expected to have a high growth trajectory, which would result in a significant increase in CO<sub>2</sub> emissions.

The chemical sector is recognized by the Indian government as one of the country's primary growth drivers and is expected to grow at 9.3% to reach US\$ 304 billion by 2025, based on rising demand from the end-user segments, especially for speciality chemicals and petrochemicals. In July 2020, production volumes of key chemicals stood at around 0.9 mtpa and petrochemicals at 1.9 mtpa. India ranks 14<sup>th</sup> in global exports and 8<sup>th</sup> in global imports of chemicals (excluding pharmaceuticals).

In 2020, the chemical industry accounted for about 160 mtpa of CO<sub>2</sub> emissions (7% of total emissions), which is expected to increase to approximately 220 mtpa by 2030, fueled by growth in speciality chemicals, petrochemicals and fertilizers. This chapter focuses on CO<sub>2</sub> emissions from the production of different segments of the chemicals sector, viz. refinery & petrochemical products, fertilizers, hydrogen, methanol and synthesis gas via coal/coke gasification.

### 2.2.4.2 Type of Primary Chemicals



#### Hydrogen

Hydrogen is widely considered a future energy carrier due to its potential uses across multiple sectors like refinery, steel, petrochemicals, power, transportation etc., with (potentially) zero CO<sub>2</sub> footprint and its potential role in the decarbonization of energy systems and as a low carbon fuel & chemical feedstock. Additionally, development and innovation in electrolyzer technologies and the availability of renewable power make the prospect of green hydrogen also realistic in the future. However, to be deployed at scale, hydrogen needs to compete with existing fossil fuels and other emerging low carbon alternatives, such as battery electric vehicles. Despite being inexpensive and

plentiful, there will be competing needs for low-carbon power, and hydrogen production via electrolysis is an extremely electro-intensive process. As a result, it's critical to analyze hydrogen's potential role from a systems viewpoint, considering the different end-uses, production routes, and value-chain combinations.

Hydrogen demand in India is currently 6 mtpa, and is confined to fertilizer plants and refineries. The development of new uses of hydrogen, cost reductions in key technologies, as well as the growing requirement to decarbonize the energy system could push hydrogen demand to roughly 11 mtpa by 2030 and 28 mtpa by 2050. Demand will remain mostly concentrated in industrial sectors, either expanding in existing sectors like fertilizers and refineries or extending into new ones like steel. Hydrogen will also have a minor role in the electricity sector as a long-term storage vector, and in the transportation sector in heavy-duty and long-distance segments. Demand for green hydrogen is expected to continue to rise after 2050, particularly in the steel and road transportation industries, as well as shipping and aviation.

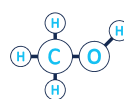

#### Methanol

Methanol is an essential chemical building block for hundreds of everyday products and applications, including plastics, paints, car parts and construction materials. Methanol is also an alternative clean energy resource that can be blended in existing fuels and used in cars, trucks, buses, ships, fuel cells, boilers and cooking stoves. India's current methanol production capacity is 0.7 mtpa, which is less than one-third of the country's total demand. The market is heavily reliant on imports from the Middle East, which account for more than 75 percent of methanol consumed in India. Methanol demand in India was 2.26 mtpa in FY 2020-21 and is expected to rise to 4.1 million tonnes by FY 2029-2030.

India has developed an indigenous technique for converting high-ash Indian coal to methanol and has set up its first pilot plant in Hyderabad for producing 0.25 tpd of 99 percent purity methanol. Conversion of coal to methanol will provide an alternate route for producing methanol and increase India's self dependence in this important energy carrier of the future, thus providing a pathway to India to lower both its crude imports and CO<sub>2</sub> emissions (i.e. when the methanol production is combined with CCUS).

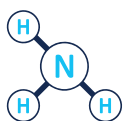

### Ammonia

India is the fourth-largest ammonia producer in the world, with production of 15.4 mtpa in 2020 and also one of the largest ammonia importers in the world. The largest demand for ammonia is for producing urea, ammonium nitrate and ammonium phosphate, which are major compounds for nitrogen-based fertilizers. Urea and ammonium phosphate fertilizers account for over 90% of ammonia demand in India.

Urea production in India is about 25 mtpa. With a growing population and food demand, the demand for urea and ammonia is also expected to grow. Ammonia is also an essential chemical needed for refrigerants. With rapid urbanization the demand for refrigerants is expected to increase, in turn impacting the demand for ammonia. Ammonia is also a basic building block for various compounds used in producing household products, cosmetics, pharmaceuticals, and in metal treating. Ammonia can also play a role in the future energy transitions as a hydrogen carrier for storing and transporting the chemical energy of hydrogen, and can be used as a transport fuel, particularly in the shipping industry.



### Synthetic Gas

Synthesis gas (syngas) production provides the foundation of many industries. Syngas is a mixture of H<sub>2</sub>/CO and is produced from gasification (coal, heavy hydrocarbons coke) or reforming (light hydrocarbons). Steam, oxygen, carbon dioxide or mixtures of them act as reforming agents and react with the carbon source at high temperatures, producing syngas of varying compositions.

The desired composition of syngas depends on the downstream applications; the most common H<sub>2</sub>/CO ratio is 2:1 for methanol and Fischer-Tropsch synthesis, or higher for hydrogen production. The generation of ethanol and higher alcohols, dimethyl ether, and oxo-alcohols use lower H<sub>2</sub>/CO ratios of about 1. When the carbon source is natural gas (methane), the conversion to syngas process is called reforming. The common technologies offer syngas with high hydrogen content (Steam Methane Reforming or SMR) or with reduced operating investment (Partial Oxidation or POX, Auto-thermal Reforming or ATR and Combined Reforming or CR). Newer technologies, which can

consume CO<sub>2</sub> (Dry Methane Reforming or DMR, Bi-reforming or BR and Tri-reforming TR) are also interesting options, even though they are more cost-intensive or produce syngas with lower H<sub>2</sub>/CO ratios, due to their reduced environmental impact under specific situations. Reliance Industries Ltd's (RIL) Jamnagar plant has the only petcoke gasification unit in India having a capacity of producing 12 mtpa of synthesis gas, which can be further used to produce various chemicals. The synthesis gas has a typical composition of H<sub>2</sub> 30-35 vol%, CO 35-40 vol% & CO<sub>2</sub> 15-20 vol%.



### Petrochemicals

Petrochemicals provide the basic raw materials for products of daily use.

Petrochemicals are primarily of two types: olefins and aromatics. The demand for petrochemicals is expanding rapidly and is expected to reach 35 mtpa by FY 2029-30. Within petrochemicals, the production of ethylene and propylene are the most emission intensive processes after ammonia. These chemicals are the building blocks for the polymer industry and are increasingly being used across diverse applications as they provide varied operational benefits over their metal counterparts.

#### 2.2.4.3 Process Description of Various CO<sub>2</sub> Sources

##### a) Refinery Unit

India's oil consumption is forecast to increase from 5 million barrels/day in 2020 to 7.2 million barrels/day in 2030 and 9.2 million barrels/day in 2050. The total refining capacity in India is about 250 mtpa, with total CDU capacity of 2300 thousand barrel/day & FCC capacity of 938 thousand barrel/day. For any complex refinery, there are multiple CO<sub>2</sub> emission sources such as Hydrogen Generation Unit (HGU), Power Plant/Co-Gen Plant (PP/CGP), Fluid Catalytic Cracking (FCC), Crude Distillation Unit (CDU) / Vacuum Distillation Unit (VDU) as well as heaters and boilers. Amongst these, the HGUs generate the most concentrated gas streams in terms of CO<sub>2</sub> (20-70 vol%), followed by CDU/VDU (10-12 vol.%), FCC (8-16 vol.%) and PP / CGP (4-8 vol%). The majority of CO<sub>2</sub> emissions in a typical refinery is contributed by the hydrogen generation unit, FCC, boilers, and process heaters. A brief description of HGU and FCC are given below:

**Hydrogen generation unit:** Hydrogen is indispensable in refinery operations for handling sour crudes as well for meeting stringent fuel norms. In India, almost all refineries produce hydrogen from natural gas (as well as naphtha) through steam methane reforming (SMR). Only RIL has a petcoke based gasifier at Jamnagar, which caters to a part of the total hydrogen requirement. In the SMR process, natural gas is fed to the reformer to react with steam over special catalyst-filled tubes to produce hydrogen and carbon monoxide. The gas stream from the SMR is conditioned in a water gas shift reactor to maximize the H<sub>2</sub> recovery. In the WGS, the carbon monoxide reacts with steam to form hydrogen and carbon dioxide. The hydrogen is then separated in a Pressure Swing Adsorption unit. Pure hydrogen with 99.9% purity is sent to end-user and the tail gas is used as fuel in the reformer unit.

The hydrogen production process and the possible CO<sub>2</sub> capture points are schematically depicted in Figure 2-24. The three gas streams where CO<sub>2</sub> can be captured are marked as 1, 2 and 3. Gas composition at these identified sources is given in Table 2-13. While

capture from tail gas or syngas (1 & 2) ensures the lowest cost of capture because of higher concentration and partial pressure of CO<sub>2</sub>, it can capture only 60% of total direct CO<sub>2</sub> emissions, whereas flue gas capture ensures over 95% direct CO<sub>2</sub> capture.

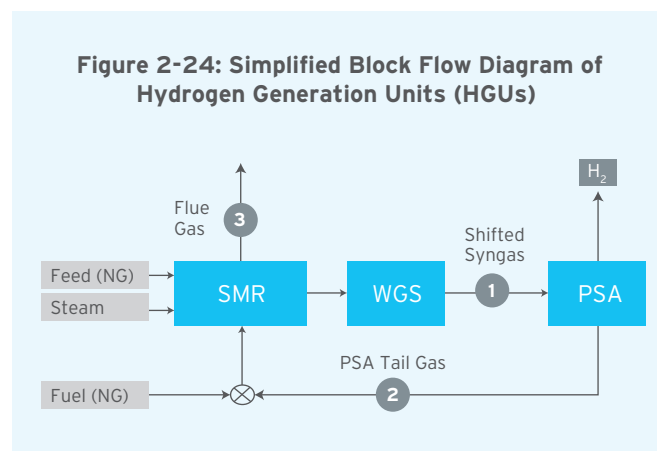

NG: Natural Gas; SMR: Steam Methane Reforming; WGS: Water Gas Shift; PSA: Pressure Swing Adsorption

**Table 2-13: Gas Composition at Different Source Points**

Parameter	Shifted syngas (vol.%, db)	PSA tail gas (vol.%, db)	Flue gas, (vol. %, db)
Carbon Dioxide	20	64	18-20
Hydrogen	77	26	
Carbon Monoxide	0.7	7	
Nitrogen			58

**Fluid Catalytic Cracking (FCC):** FCC helps in improving the recovery from crude through cracking higher hydrocarbons. Crude is allowed to react with steam in a fluidized bed (or fluid-bed) of catalyst particles. When the heated catalyst particles come in the presence of the feed, they evaporate it, and cracking begins as the gas oil vapors and catalyst particles migrate upward in the reactor. During the upward movement, the temperature of the catalyst particles reduces as the gas oil evaporates and endothermic cracking processes occur. Cracking processes also deposit a coke layer on the catalysts,

causing them to become inactive. The coked catalyst is transferred to the regeneration unit before they are reintroduced to the riser. After being separated from the catalyst particles in the upper section of the reactor, the cracking products are transferred to the fractionator for recovery. In the regeneration unit, the deposited coke layer of catalyst is burnt at around 700-800°C, and this is a primary source of CO<sub>2</sub> emission. The CO<sub>2</sub> concentrations at different units of a typical refinery operation, as shown in Table 2-14, vary depending on the respective processes.



**Table 2-14: CO<sub>2</sub> Concentration at Different Refinery Units**

Unit	Section	CO <sub>2</sub> vol% (db)
FCC	FCCU Regenerator	8.5
SMR	Reformer Flue	18-22
CDU	Crude distillation Unit	11
DCU	Coke heater	8.5
Reformer heater	Reformer heater	4
VDU	Vacuum Unit	11
Naphtha splitter	Reformer-Naphtha splitter	8.5
HC	Hydrocracker	8.5
HC-Heater	Hydrocracker Heater	8.5
HDS	Hydrodesulfurization	8.5
HDS-Heater	HDS- Charge heater	4
SRU	Sulfur removal & tail gas treatment	4
FCCU Heater	FCCU heater	4

### b) Petrochemical Unit

The petrochemical industry generates various kinds of chemical products such as polymers, fibers or rubber, from such raw materials as petroleum, LPG, natural gas, and other hydrocarbons through different production processes. The source feedstock, i.e. light or heavy hydrocarbons, are used to produce a variety of components including ethylene, propylene, butadiene and pyrolysis gasoline through non-catalytic thermal decomposition reaction with steam (thermal cracking). Pyrolysis of hydrocarbons is the most critical process in petrochemical production and presents the main source for most basic organic industrial raw materials:  $\alpha$ -olefins (ethylene, propylene, isobutane, butene), butadiene, and aromatic hydrocarbons (BTX = benzene, toluene, xylene). The most CO<sub>2</sub> emission intensive process is the production of ethylene through the following processes:

**Steam Cracking:** In steam cracking, a gaseous or liquid hydrocarbon feed-like ethane, propane, butane, naphtha, gas oil is diluted with steam and then heated in a furnace without oxygen. Typically, the endothermic reaction temperature is very hot (around 850°C) and allowed to take place with short residence time (resulting in gas velocities reaching speeds beyond the speed of sound) in the furnace coils. In modern cracking furnaces, the residence time is reduced to milliseconds in order to improve the yield of the desired products. After the cracking temperature has been reached, the gas is quickly quenched to stop the undesirable reaction in the downstream transfer line exchanger. The products produced in the reaction depend on the composition of the feed, on the hydrocarbon to steam ratio and on the cracking temperature and furnace residence time. The flue gas temperature is at around 1100-1200°C depending upon fuel gas composition.

Light hydrocarbon feeds (such as ethane, propane, or light naphtha) give product streams rich in the lighter alkenes, including ethylene, propylene, and butadiene while heavier hydrocarbons (full range and heavy naphtha as well as other refinery products) feeds give some of these, but also give products rich in aromatic hydrocarbons and hydrocarbons suitable for inclusion in gasoline or fuel oil. The higher cracking temperature favors the production of ethylene and benzene, whereas lower severity produces relatively higher amounts of propylene, C4 cut, and liquid products.

**Gas composition:** The exhaust flue gas is a CO<sub>2</sub> rich product, depending upon the type of fuel, combusted in modern low SO<sub>x</sub>-NO<sub>x</sub> burners. Normally the methane content varies from 60-70 vol% in the gaseous fuel. The typical flue gas composition with 10-15 vol% excess air is given Table 2-15.

**Table 2-15: Cracker Furnace Flue Gas Composition**

Parameter	vol% (db)
CO <sub>2</sub>	11-13
H <sub>2</sub>	3-4
N <sub>2</sub>	85-87
CO	100-200 ppm

### c) Fertilizer Unit

A typical fertilizer unit comprises hydrogen production, ammonia production and urea production. Most fertilizer plants in India operate with natural gas based SMR for hydrogen production, which is similar to refineries. However, CO<sub>2</sub> removal after the water gas shift reactor is an added process in fertilizer plants, since CO<sub>2</sub> is required for production of urea. In a fertilizer complex, the majority of CO<sub>2</sub> emission is contributed by hydrogen production. A part of CO<sub>2</sub> is consumed in downstream urea production. A brief description of the ammonia and urea production process is given below:

**Ammonia production:** The Haber process, in which nitrogen and hydrogen combine in the presence of an iron catalyst to make ammonia, is the most common method of producing ammonia. The cooled, compressed gas combination is supplied into the ammonia production loop. The incoming gas stream is mixed with a mixture of ammonia and unreacted gases that have already travelled around the loop and chilled to 5°C. The ammonia is removed, and the unreacted gases are heated to 400°C and passed over an iron catalyst. 26 percent of the hydrogen and nitrogen are transformed to ammonia under these conditions. The ammonia converter's discharge gas is cooled from 220 to 230°C. Moreover half of the ammonia is condensed during the cooling process, which is subsequently separated. The residual gas is combined with incoming gas that has been cooled and compressed. The ammonia is compressed quickly to 24 barg. The ammonia recovery machine removes the gas mixture above the liquid ammonia (which also includes considerable levels of ammonia).

**Urea production:** Urea is produced from ammonia and carbon dioxide. A mixture of compressed CO<sub>2</sub>

and ammonia at 240 barg is reacted to form ammonium carbamate in two stage reactors. The major impurities in the mixture at this stage are water from the urea production reaction and unconsumed reactants (ammonia, carbon dioxide and ammonium carbamate). The unconsumed reactants are removed in three stages with a series of pressure reduction and heating. By the time the mixture is at 0.35 barg, a solution of urea dissolved in water and free of other impurities remains. The urea solution is heated under vacuum, which increases the urea concentration from 68% to 80% w/w. At this stage some urea crystals also form. The solution is then heated from 80°C to 110°C to redissolve these crystals prior to evaporation. In the evaporation stage molten urea (99% w/w) is produced at 140°C. Urea is sold as 2 - 4 mm diameter granules. These granules are formed by spraying molten urea onto seed granules which are supported on a bed of air.

#### 2.2.4.4 CO<sub>2</sub> Emissions from the Chemical Industry

Based on the CO<sub>2</sub> emission intensities for various process units in the chemical industry, the direct process emissions may be considered for CO<sub>2</sub> capture and further utilization or sequestration. Based on the production data from various industries, the sector-wise production of different chemicals through various routes and the associated CO<sub>2</sub> emissions have been estimated.

The major sources of CO<sub>2</sub> emissions are hydrogen production in refineries, production of olefin, urea & syngas. Out of these emissions, only those from direct processes, apart from the utility CPP associated with these units, account for the capturable CO<sub>2</sub> volumes due to their possibility of integration with CCU facilities. The distribution of CO<sub>2</sub> emitted by the chemical industry is provided in Table 2-16.



**Table 2-16: Total CO<sub>2</sub> Emissions from Refineries, Petrochemicals & Fertilizers**

Products	Production in 2020, mtpa	Emission Intensity, TCO <sub>2</sub> /TProduct	CO <sub>2</sub> emissions in 2020, mtpa	Expected production 2030, mtpa	Estimated CO <sub>2</sub> emissions in 2030, mtpa
Ethylene	7.2	1.2	8.6	10.5	12.6
Methanol	0.7	0.5	0.4	4.1	2.1
Ethylene Oxide	1.36	0.5	0.7	2.2	1.1
Syngas (via coke)	10	2	20	12	24.0
SMR based hydrogen*	6	8.5 - 11	56	11	102
Refinery (CDU & FCC)	250	0.2	50	350	70.0
Vinyl Chloride	1.6	0.3	0.5	2	0.6
Urea	25	0.7	17.5	40	28.0
DAP	4.65	0.73	3.4	8	5.8
Complex + SSP	10	0.76	7.6	19	14.4
<b>Total</b>			<b>165</b>		<b>261</b>

**Note:** \*Most SMRs have the flexibility to take both NG and naphtha as feed, depending on the price. For calculating the CO<sub>2</sub> emissions, we have assumed 70% production from NG & 30% from naphtha.

## 2.2.5 CO<sub>2</sub> Emissions: Upstream Oil & Gas Exploration

### 2.2.5.1 Introduction

Exploration and production activities (E&P) to extract oil and gas from the subsurface are crucial in order to reduce the import dependency of petroleum and natural gas and ensure energy security. The fossil fuels thus produced are further refined to produce various value-added products that empower the Indian economy. The domestic production of oil and gas from FY 2014-15 to FY 2019-20 has been on a decline, as shown in Figure 2-25 and Figure 2-26.

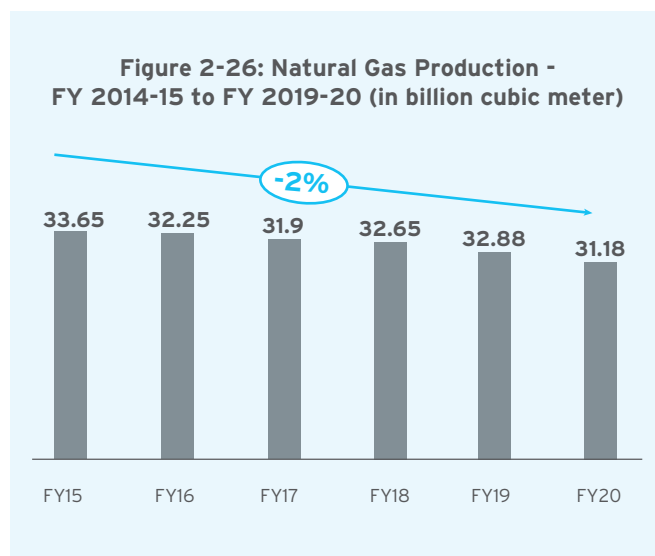
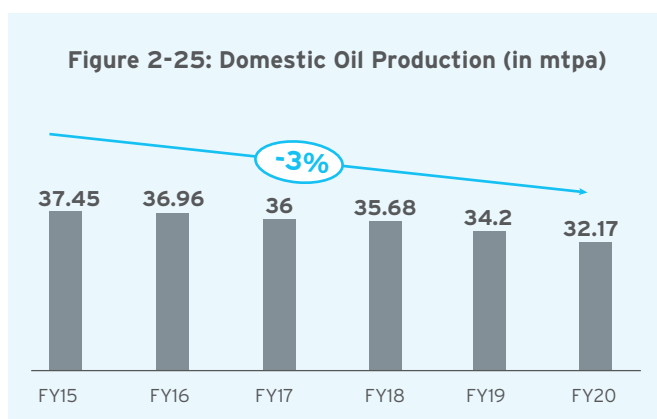

In the year FY 2019-20, ONGC accounted for about 64% of the crude oil production, followed by CEIL (Cairn Energy India Limited), accounting for 24% of crude oil production and OIL, with 10% of the total crude oil production.

In the year FY 2019-20, natural gas production was also led by ONGC, producing 76% of the total natural gas production. It was followed by OIL

accounting for 9% and CEIL accounting for 6% of the total production (India's Hydrocarbon Outlook, 2020).

**Figure 2-27: Oil Production by Operator in FY 2019-20 (in mtpa)**

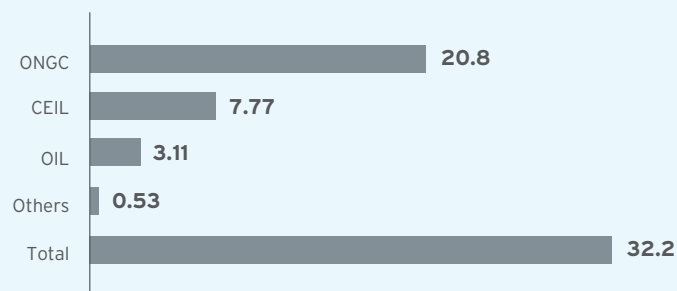

**Figure 2-28: Natural Gas Production in FY 2019-20 (in billion cubic meters)**

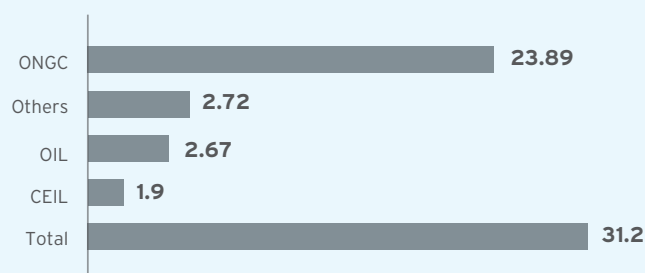

### 2.2.5.2 CO<sub>2</sub> Emission from the E&P Industry

The majority of the emissions in the upstream oil and gas exploration and production consists of methane, with some CO<sub>2</sub> also being released during flaring and during power generation required to operate drilling and other necessary equipment. The methane emissions thus need to be considered along with the CO<sub>2</sub> emissions and represented in terms of CO<sub>2</sub>eq.

To estimate the emissions from the upstream oil & gas operations, an emission intensity factor has been estimated. This has been done using the

emissions data for oil and gas production activities provided in World Energy Outlook (2018). The emission intensity factor thus obtained has been adjusted for the Indian scenario and used to estimate the CO<sub>2</sub>eq emissions from the oil and gas production data. The emission intensity for upstream activities for crude oil production is calculated to be 0.04 tCO<sub>2</sub>eq/toil and for upstream activities involved in natural gas production, the emission intensity is calculated to be 0.2 tonneCO<sub>2</sub>eq/bcmgas. Accordingly, the total CO<sub>2</sub> emissions have been tabulated in Table 2-17.

**Table 2-17: Total CO<sub>2</sub> Emissions from Oil & Gas Upstream Operations**

Products	Units	Production	CO <sub>2</sub> emission, mtpa of CO <sub>2</sub> eq
Crude Oil	mtpa	32.17	9.43
Natural Gas	billion cubic meter	31.18	6.24
<b>Total</b>			<b>15.7</b>

ONGC is the largest producer of crude oil and natural gas and has the lion’s share of the total

emission from the upstream E&P sector, followed by CEIL (Cairn Energy India Limited) and OIL.

**Figure 2-29: Carbon Emission by E&P Operator in FY 2019-20 (in mtpa of CO<sub>2</sub>eq)**

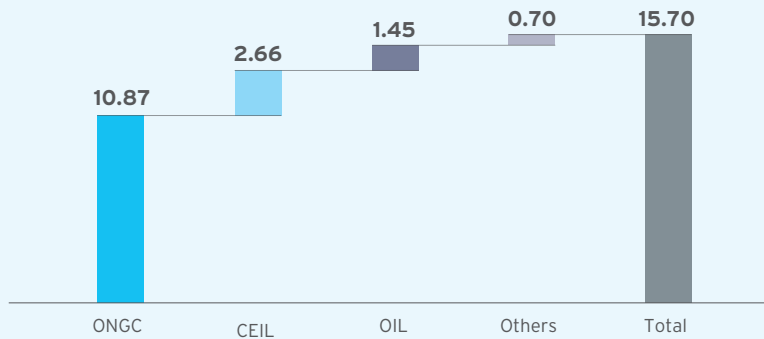

The forecasted domestic production data for oil in FY 2029-30 is expected to decline to 27 mtpa of oil, while natural gas production is expected to increase to 55 billion cubic meters (source: India Energy Outlook, 2021). Based on these forecasts, the corresponding emissions have been estimated for

FY 2029-2030 using the emission intensity factors. The increase in natural gas production will result in higher CO<sub>2</sub> emission volumes, and will offset the decrease due to lower crude oil production. Overall emissions in FY 2029-30 from upstream oil & gas operations is expected to reach 19 mtpa CO<sub>2</sub>eq.

**Figure 2-30: Emissions Projection for 2030, MT CO<sub>2</sub>eq**

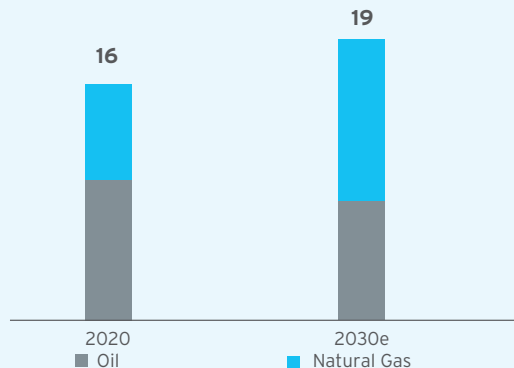



## 2.2.6 CO<sub>2</sub> Emissions: Gasification

### 2.2.6.1 Introduction

In India, coal is the most abundant and important fossil fuel. Despite a drop in demand due to the COVID-19 pandemic, India's coal production reached 730 mtpa in the fiscal year FY 2019-20 and 716 mtpa in FY 2020-21. The gasification of coal produces synthesis gas, which can be converted into a diverse slate of products such as hydrogen, methanol, ethanol, olefins, ammonia, acetic acid, DME and others. The Hon'ble Prime Minister has set a lofty goal of gasifying 100 mtpa of coal by the year 2030.

Coal gasification can help India become आत्मनिर्भर by substituting imports of crude oil and other value-added chemicals to meet the needs of a growing and resource-hungry nation. It is imperative for coal gasification to be combined with CCUS and provide a sustainable and clean pathway for producing chemicals and transportation fuels. In order to support this infant industry, financial support from the Government of India is necessary to help CCUS-enabled coal gasification projects compete with the conventional and carbon unabated fossil fuel (primarily NG) based manufacturing routes of these products.

As of today, there is only one commercial-scale coal gasifier operating in India, at JSPL Angul. The syngas feeds to a gas-based DRI unit. Given the importance of developing gasification technologies and projects suitable for high ash Indian coals, the Ministry of Coal has planned a three phase strategy for developing commercial-scale gasification projects:

**i) Phase I:** Establishing a pilot project through two gasification projects for gasifying about 4 mtpa of coal. These projects are the Talcher Fertilizer Plant and the Dankuni Methanol complex. The Talcher Fertilizer Plant is a joint venture of Coal India Limited (CIL), Rashtriya Chemicals & Fertilizers (RCF), and GAIL India Limited, and will be based on gasification of high ash coal with petcoke blending. The methanol plant in Dankuni will use low-ash coal from the country's eastern region and will be built under the Build-Own-Operate (BOO) method with an estimated investment of Rs. 20,000 crore.

**ii) Phase II:** Coal India Limited has identified four key gasification projects to be implemented through its subsidiaries: Eastern Coalfields Limited (ECL), South-Eastern Coalfields Limited (SECL), Central Coalfields Limited (CCL), and Western Coalfields Limited (WCL). These projects aim to gasify 6 mtpa of coal for producing different chemicals such as methanol, ammonium nitrate and synthetic natural gas.

**iii) Phase III:** Phase III aims to gasification the balance quantity of coal (as per the vision of the Government) by identifying new projects, following the successful implementation of the Phase II projects.

### 2.2.6.2 Process Description

A typical block flow diagram is shown in Figure 2-31. Details of major blocks like gasification and gas processing part is explained below:

**Gasification:** Coal after beneficiation and grinding is fed to the gasifiers. The coal reacts with steam and oxygen to produce syngas comprising of H<sub>2</sub>, CO, CO<sub>2</sub> along with H<sub>2</sub>S and other impurities. The hot gas is passed through a cooler where high pressure steam is generated through a heat exchanger. The steam is recycled partially in the gasifier and the balance is used for downstream gas conditioning units. Syngas comes out of cooler is passed through a series of filters to remove the particulate matters present in the gas. The particulate matters are recycled in the gasifier. Further, the cooled and particulate free syngas is scrubbed with water to remove corrosive chlorides present in the syngas. From the scrubber, the syngas is piped to the water gas shift reactor for gas conditioning.

**Water gas shift:** Based on the downstream requirements, the raw syngas needs to be processed to conform to a certain hydrogen/carbon monoxide (H<sub>2</sub>/CO) ratio, depending on the downstream application. To achieve the desired H<sub>2</sub>/CO ratio, the syngas is passed through a double-stage fixed bed reactor containing shift catalysts. This process converts a part of the CO and water of the syngas to additional CO<sub>2</sub> and H<sub>2</sub>. This process increases the H<sub>2</sub>/CO ratio as well as CO<sub>2</sub> content in the shifted gas.

Excess moisture present in the syngas takes part in the shift reaction to achieve the required H<sub>2</sub>/CO composition. The required additional steam is injected to the reactor.

**Acid gas removal:** Syngas conditioned in the water gas shift process contains CO<sub>2</sub> and H<sub>2</sub>S which are removed in the acid gas removal unit. CO<sub>2</sub> is captured and sent to the carbon dioxide processing

hub for compression. The H<sub>2</sub>S in the syngas is also captured and sent to the sulphur recovery unit. There are multiple commercially proven absorption processes using both physical and chemical solvents. However, due to the high concentration of CO<sub>2</sub> at the inlet of the acid gas removal process, a physical solvent based acid gas removal system is generally used.

Figure 2-31: A Typical Coal Gasification Based Ecosystem

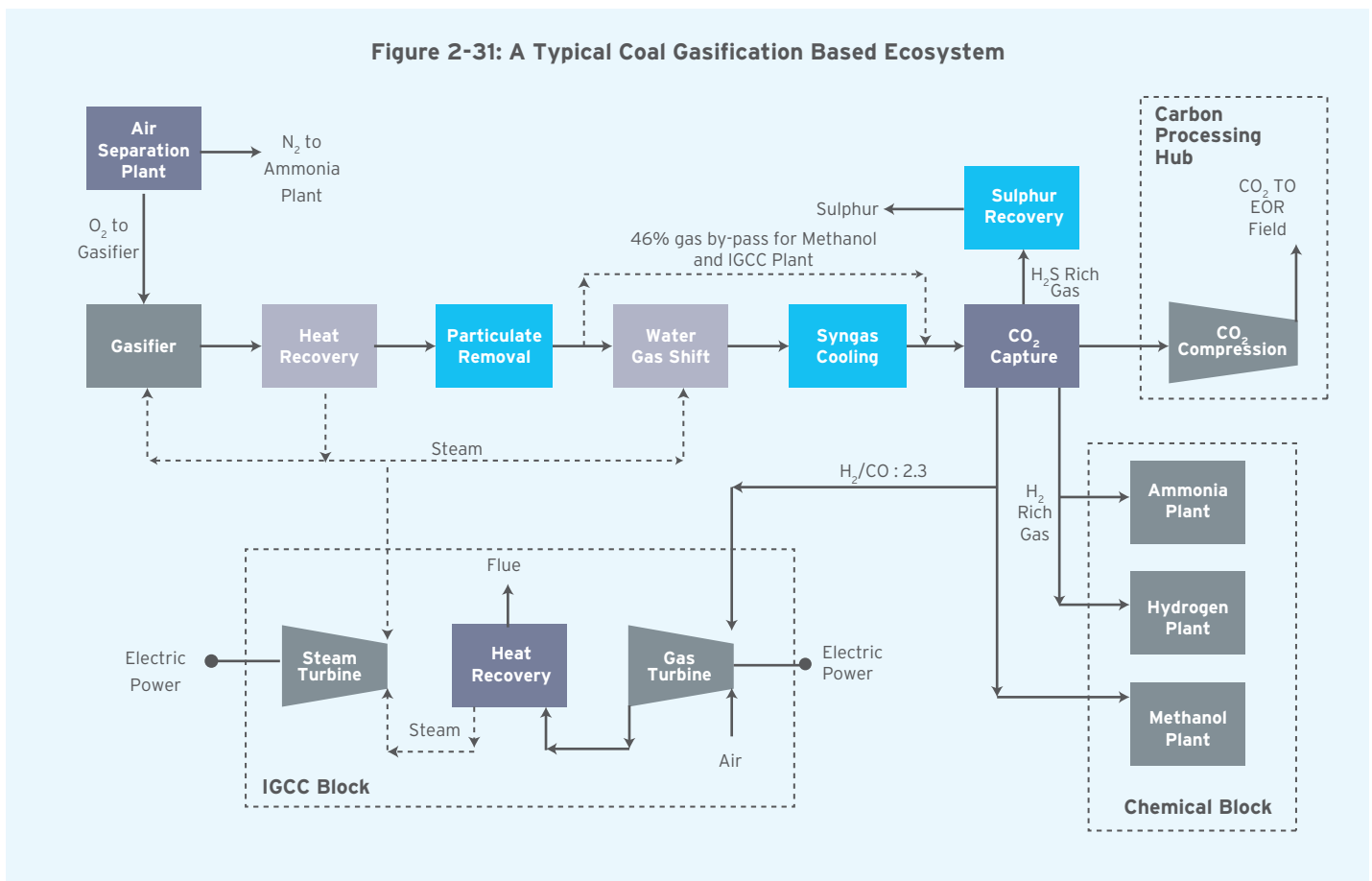

### 2.2.6.3 CO<sub>2</sub> Emission from the Gasification Industry

Though the Government of India has envisioned 100 mtpa of coal gasification by 2030, actual implementation may be delayed given the progress of the existing projects and the long gestation period and uncertainties involving gasification projects. The CO<sub>2</sub> emissions have been estimated considering the

announced projects, as well as 1 mtpa hydrogen production from coal gasification. Based on the values of emission intensities for various end product through syngas route, the capturable direct process emissions have been considered. The actual CO<sub>2</sub> emissions will vary based on the actual downstream products produced from the syngas.

**Table 2-18: Total CO<sub>2</sub> Emission from Coal Gasification**

Products	Emission Intensity, TCO <sub>2</sub> /TProduct	Expected production 2030, mtpa	CO <sub>2</sub> emission projection in 2030, mtpa
Hydrogen	13 - 15	1	14.0
Methanol	2 - 2.7	2	5.0
Ammonia	3 - 3.5	1.4	4.6
Urea	1.5 - 1.7	2	3.2
<b>Total</b>			<b>27</b>

## 2.3 Key Interventions Required

The estimated CO<sub>2</sub> emissions from key sectors of the Indian economy requiring CCUS interventions are tabulated below:

**Table 2-19: Sector-wise CO<sub>2</sub> Emissions and Interventions Required**

Sector	Estimated CO <sub>2</sub> emissions (in mtpa)		Rationale for CCUS	Key interventions required
	2020	2030		
Thermal power generation	1,004	1,210	Even with RE growth, coal-based power will continue to meet more than 50% of electricity demand. As the largest emitter of CO <sub>2</sub> , CCUS of the power sector is essential for meaningful decarbonization and ensuring energy security in India	Establish CCUS clusters in key identified districts
Steel	240	450	Future steel growth is largely based on the BF-BOF route, where use of fossil fuels is hard to replace. CCUS is necessary for sustainability and also ensures export competitiveness	Establish CCUS for Integrated Steel Plants, particularly in Eastern India
Cement	196	325	Another major CO <sub>2</sub> emitter, where fossil fuels are difficult to replace. Utilization of CO <sub>2</sub> in aggregates has synergies with the cement business	Establish CCUS clusters in key identified areas/districts
Oil & gas upstream, refineries & chemicals	125	177	Hard to abate sector. CCUS essential for the sustainability of the sector; carbon capture inbuilt in many of the processes	Decarbonize key applications like urea, olefins, syngas from petcoke
Hydrogen	56	102	Blue hydrogen is key to the hydrogen economy of the future. Carbon capture is unbuilt in the H <sub>2</sub> production process	Establish pathways for CO <sub>2</sub> utilization and storage
Coal gasification	-	27	Sunrise sector - key to materials and energy security of India, based on India's rich endowments of coal	Establish pathways for CO <sub>2</sub> utilization and storage
<b>Total</b>	<b>1621</b>	<b>2291</b>		

The categorization of emissions depending on CO<sub>2</sub> concentration, stream, pressure, synergy with existing operations, as well as CO<sub>2</sub> emission baselining is an immediate requirement for the development of carbon capture projects in India. Capturing from high concentration CO<sub>2</sub> sources (more than 30%) like HGU tail gas, gasification, etc. will reduce the CO<sub>2</sub> footprint with a low to moderate cost impact; however, the capturable CO<sub>2</sub> volume is limited to 100-150 mtpa i.e., 4 to 6% only of overall CO<sub>2</sub> emissions. So, it is important to prioritize carbon capture demonstration projects for high CO<sub>2</sub> concentration and low to medium volume sources.

Once technologies, as well as the disposition strategy, are finalized and demonstrated at a certain scale, carbon capture for low concentration and high volume sources such as power plants, steel & cement plants can be gradually taken up. However, the CO<sub>2</sub> volume for power and steel plants is often more than 5 mtpa, which is significantly higher than any other industry. So, it will be advantageous to develop CCU cluster infrastructure based on large-scale power or steel projects as anchor projects, which will lower the CCUS infrastructure costs for small and medium scale CO<sub>2</sub> emitters and enable them to adopt carbon capture projects.





## Chapter 3

# Overview of CO<sub>2</sub> Capture & Utilization Technologies



## 3.1 Introduction to Carbon Capture Technologies

CO<sub>2</sub> capture technologies separate carbon dioxide from gas streams that are released from industrial processes such as power plants, chemical production, cement production or steel making. There are three different

broad categories of technologies for capturing CO<sub>2</sub>: post-combustion capture, pre-combustion and oxy-fuel combustion. The operating principles of each is depicted in Figure 3-1.

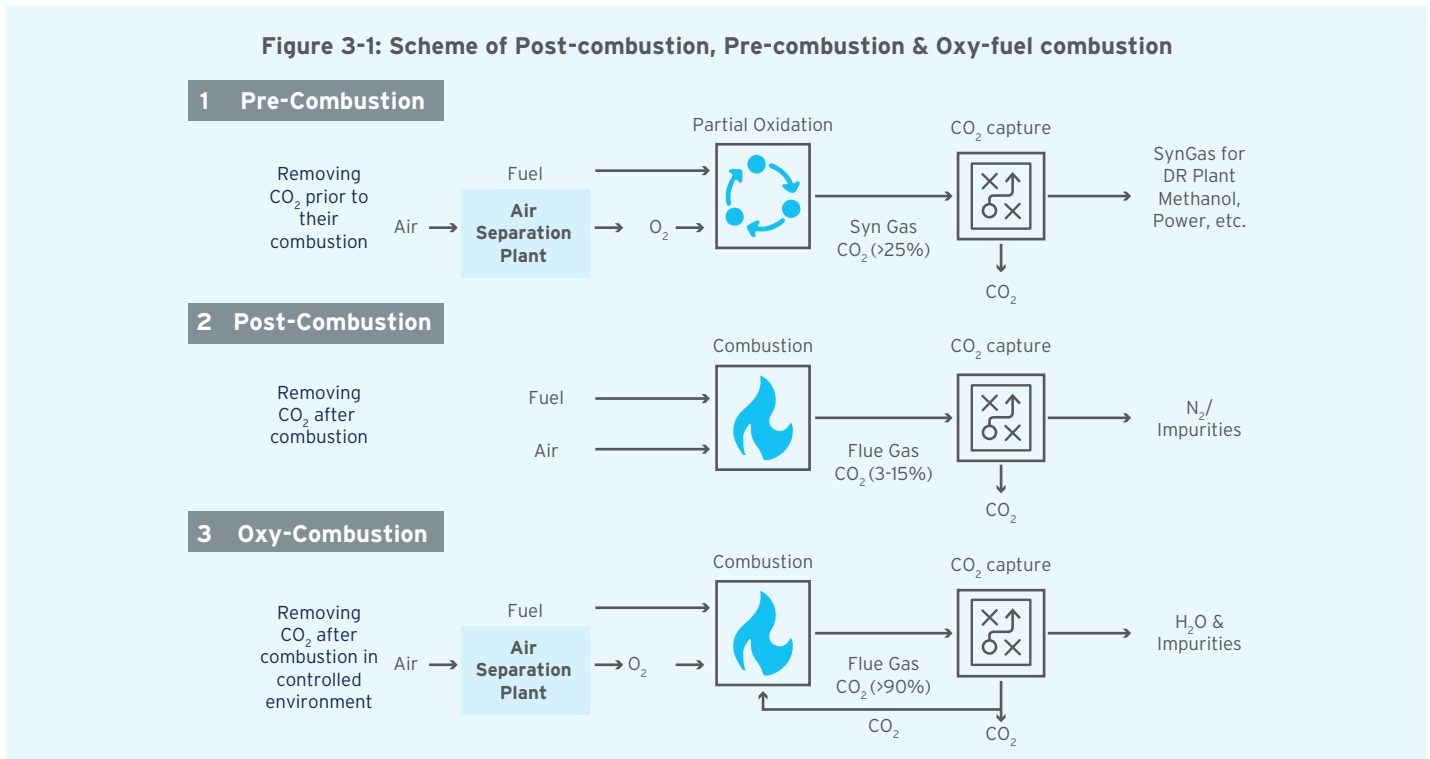

- (i) **Post-combustion technologies:** CO<sub>2</sub> is separated from the flue gas after combustion. Fossil fuels like coal, oil, NG etc., are burnt in the presence of air; hence the flue gas is rich in N<sub>2</sub>, and the CO<sub>2</sub> percentage typically varies between 3% to 15%. Since the partial pressure of CO<sub>2</sub> in the flue gas is quite low, very high-volume chemical solvent (amine) circulation is required for CO<sub>2</sub> capture, making post-combustion technologies energy and cost-intensive.
- (ii) **Pre-combustion technologies:** they involve removing CO<sub>2</sub> through the upstream treatment of fossil fuels prior to combustion. The major difference between pre-combustion and post-combustion is that the former is favoured in cases where the gas stream has a higher partial pressure of CO<sub>2</sub>, such as in gasification of fossil fuels, NG based H<sub>2</sub> production or sour gas processing. Since no chemical bonds need to be broken for solvent regeneration, the thermal energy penalty is much lower.

The regeneration of the physical solvent is primarily achieved by reducing pressure.

- (iii) **Oxy-fuel combustion technologies:** While post-combustion and pre-combustion carbon capture technologies have been commercially established, oxy-fuel combustion technologies are still in the developmental stage. Oxy-fuel combustion represents an emerging novel approach to near zero-emission. It is accomplished by burning the fuel in pure oxygen (O<sub>2</sub>) instead of air (O<sub>2</sub> and N<sub>2</sub>). The flue gas stream would be primarily composed of water and CO<sub>2</sub>, rather than N<sub>2</sub>. High purity CO<sub>2</sub> can be recovered by the condensation of water.

**Direct Air Capture (DAC):** DAC directly captures dilute CO<sub>2</sub> (at 415 ppm) from the air, and may also emerge as a form of carbon capture that has wide applicability, as it is independent of the source and concentration of the emission stream. However, DAC is still in early stages and the economics and scale of operations are yet to be established.



## 3.2 Mature and Commercially Proven CO<sub>2</sub> Capture Technologies

The mature and commercially proven CO<sub>2</sub> capture technologies can be broadly classified into three groups, as shown below. Additionally, there are membrane, microbial and algae-based CO<sub>2</sub> capture technologies, but these are at the developmental stage.

- i) Solvent-based absorption**
  - a) Physical solvent based absorption
  - b) Chemical solvent based absorption
- ii) Adsorption**
- iii) Cryogenic separation**

A simplified schematic depiction of these matured technologies is shown in Figure 3-2.

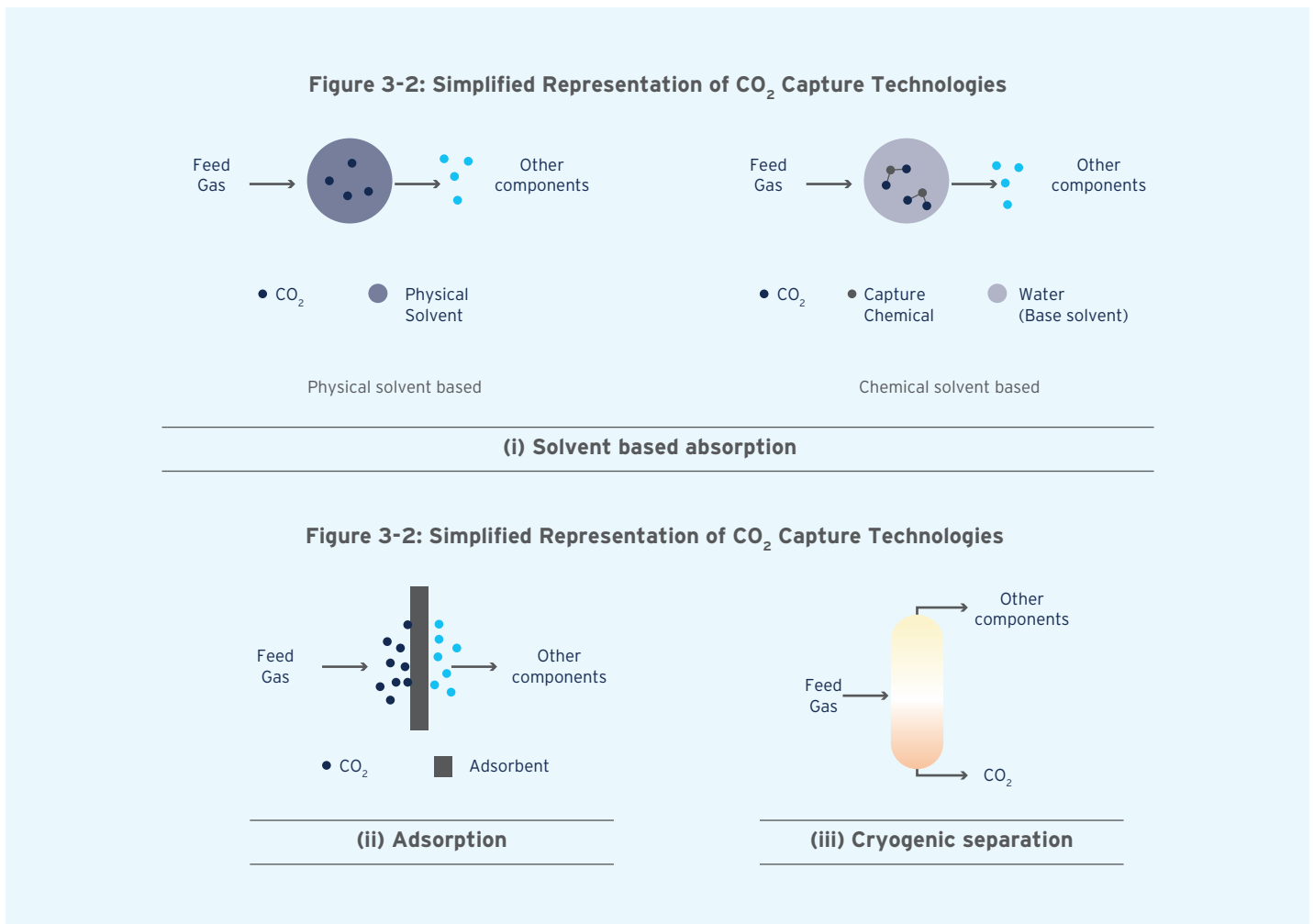

Brief descriptions of the aforementioned commercially proven and matured carbon capture technologies are provided.

### 3.2.1 Solvent-Based Absorption

Solvent-based CO<sub>2</sub> capture processes have been used for over half a century for processing natural (sour) gas, combustion flue gas and Fischer-Tropsch (FT) synthesis products. The fundamental principle on which

solvent-based CO<sub>2</sub> capture technologies work is 'selective absorption' of CO<sub>2</sub> over the other gaseous constituents. The working principle of solvent-based CO<sub>2</sub> capture is depicted in a schematic flow diagram in Figure 3-3.

**Figure 3-3: Schematic Representation of Working Principle of Solvent-Based CO<sub>2</sub> Capture**

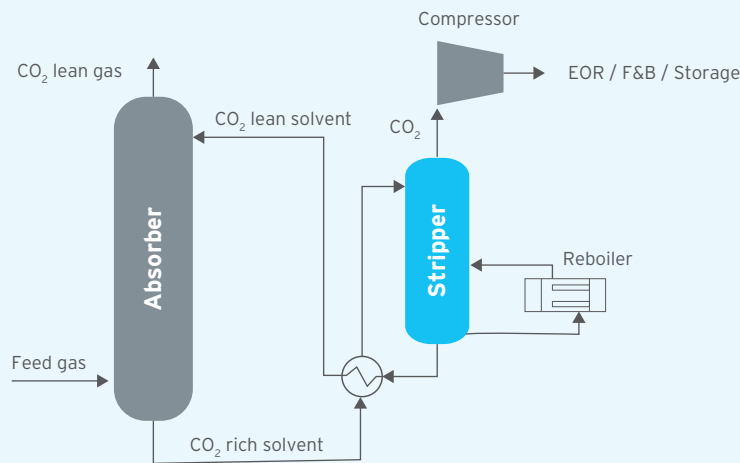

While the CO<sub>2</sub> present in the feed/process gas is first selectively absorbed in an absorber using a solvent (physical or chemical), the CO<sub>2</sub> lean gas exits the absorber. Next, the CO<sub>2</sub> rich solvent is sent to a stripper-type configuration where the CO<sub>2</sub> is released from the solvent and the lean solvent is regenerated for reuse. The CO<sub>2</sub> rich stream needs to be purified, dehydrated, and compressed to raise the pressure to the required level: supercritical CO<sub>2</sub> for pipeline transportation or liquefied CO<sub>2</sub> for ship or road transportation. Supercritical CO<sub>2</sub> can be obtained at pressures of >74 bar(a) at ambient temperature, whereas liquefied CO<sub>2</sub> can be obtained at pressures of 6-7 bar(a) at a temperature of about -50 °C. In the case of pipeline transportation to oilfields for EOR, the exit pressure at the carbon capture complex is determined based on the transportation distance and miscibility pressure requirements in the oil reservoir.

the relationship between the CO<sub>2</sub> absorption capacities of chemical and physical solvents (known as 'solvent loading') and partial pressure of CO<sub>2</sub> in the gas stream is provided in Figure 3-4.

The solvent-based CO<sub>2</sub> capture technologies are distinguished based on whether CO<sub>2</sub> reacts with the solvent chemically (chemical absorption) or dissolved physically (physical absorption). A schematic depiction of

**Figure 3-4: Schematic Representation of CO<sub>2</sub> Absorption Capacity of Chemical and Physical Solvents as a Function of the Partial Pressure of CO<sub>2</sub>**

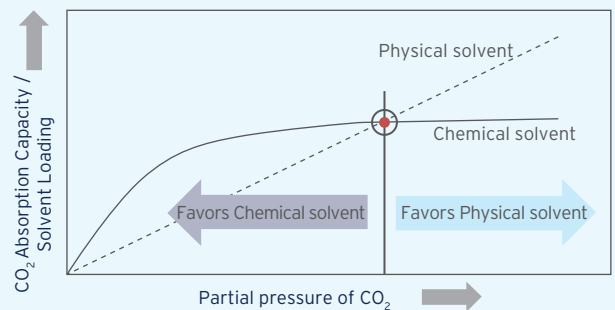

Chemical absorption based CO<sub>2</sub> capture is better suited for gas streams having a low concentration and partial pressure of CO<sub>2</sub> due to the high chemical affinity of CO<sub>2</sub> to amine-/carbonate-based chemical solvents as well as faster rate kinetics. While the chemical solvents can achieve high absorption capacity at low partial pressures of CO<sub>2</sub>, a non-reactive or physical solvent performs well at higher partial pressures of CO<sub>2</sub>. As shown in Figure 3-4, the solubility curve for a physical solvent typically follows Henry's law, i.e., a linear relationship with the partial pressure of CO<sub>2</sub>.

A chart depicting the operating ranges of various solvents for CO<sub>2</sub> capture is shown in Figure 3-5 and forms the basis for selecting suitable CO<sub>2</sub> solvents. The low CO<sub>2</sub> partial pressures in the flue gas of coal-fired power plants make amine-based chemical absorption the preferred technique. However, relatively higher gas stream pressure and CO<sub>2</sub> concentration, such as in the syngas of gasifiers and SMRs make physical absorption-based capture more suitable.

**Figure 3-5: Operating Regimes of Various Solvents for CO<sub>2</sub> Capture**

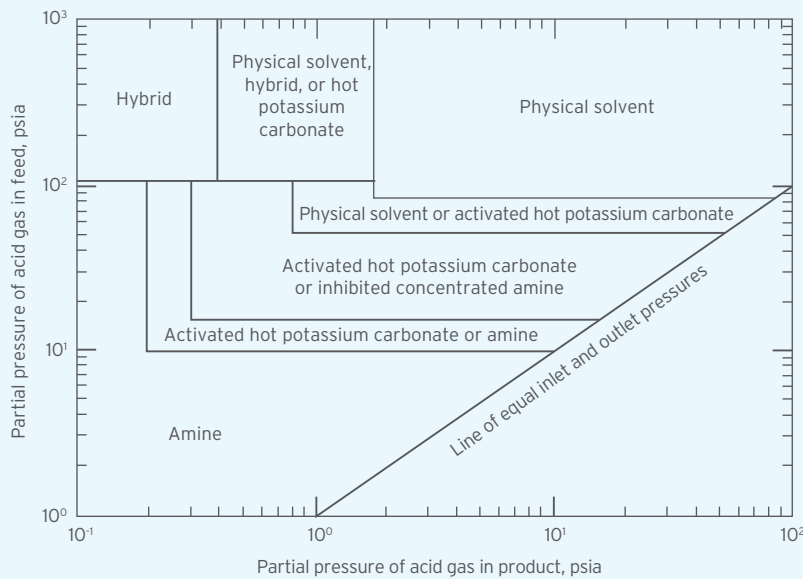

Source: NETL, US Department of Energy (DOE)

### 3.2.1.1 Chemical Solvent-Based Absorption

A basic flow diagram for a chemical solvent-based CO<sub>2</sub> capture is depicted in Figure 3-6. The chemical reaction between CO<sub>2</sub> and the chemical solvent is an exothermic reaction and hence favoured at lower

temperatures. Hence it is necessary to pre-cool the feed gas. During the cooling of the feed gas, water condenses out of the wet gas.

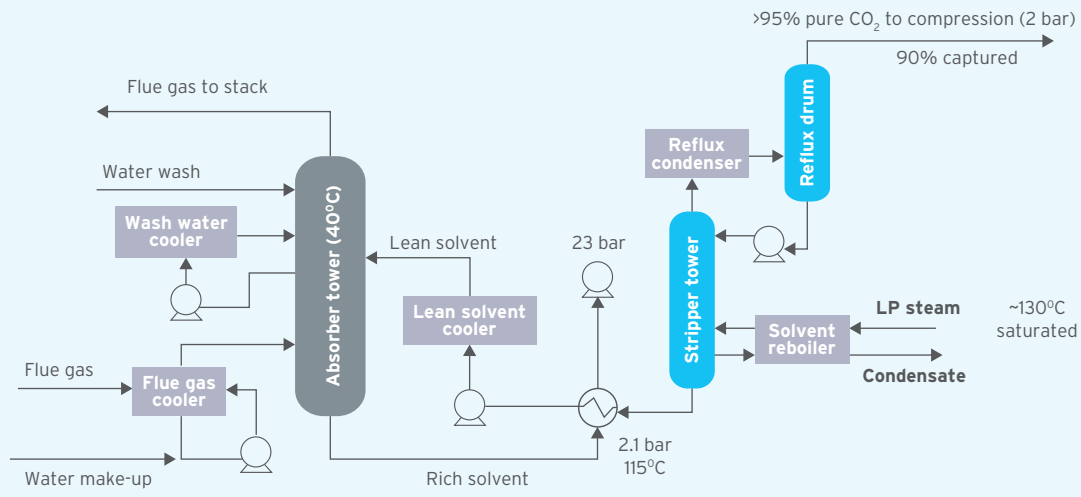
**Figure 3-6: Typical Flow Diagram of a Chemical Solvent Based CO<sub>2</sub> Capture**

The cooled gas stream reacts with the amine-based solvent at 40-60°C via a countercurrent flow reaction within the absorber column, resulting in:

- CO<sub>2</sub> free gas stream; and
- Solvent with chemically bound CO<sub>2</sub>

Multiple stages of structured packing in the absorber columns maximize the contacting surface area and mass transfer rate of CO<sub>2</sub> in the solvent during the countercurrent flow. While the CO<sub>2</sub> depleted gas stream leaves the absorber from its top stage, the CO<sub>2</sub> rich solvent stream exits the absorber column from its bottom stage, and is pumped to the stripper, where the application of higher temperatures (100-140°C) results in regeneration of the solvent by breaking the chemical bonds between CO<sub>2</sub> and the chemical solvent. The heat required for the regeneration of the solvent is provided by a reboiler, supplied with steam extracted from captive CHPs/CGPs. Such a heat and strip operation for the regeneration of the solvent leads to a high thermal energy penalty. Depending on the solvent used and system configuration, the steam consumption for solvent regeneration can range from 1.1 to 1.5 t/tCO<sub>2</sub>.

While the dense CO<sub>2</sub> stream exits the stripper from its top stage, the CO<sub>2</sub> lean solution is cooled and recirculated to the absorber. Typically, the absorber and stripper's operating pressures for chemical solvent-based capture are low, ranging from 1 - 4 bar(a). The primary characteristics of a solvent that need to be analyzed to determine its efficacy are as follows:

- Rate kinetics:** Faster rates of reaction between the solvent and CO<sub>2</sub> ensure better mass transfer performance at the gas-liquid interface, thus facilitating a smaller absorber volume and a lower cost of capture.
- CO<sub>2</sub> carrying capacity:** A higher CO<sub>2</sub> carrying capacity of the solvent reduces the regeneration load, auxiliary unit costs and energy requirements.
- Reaction enthalpy:** A lower enthalpy for the reaction between the solvent and CO<sub>2</sub> transpires into lower energy requirements to break the solvent-CO<sub>2</sub> bond during desorption.
- Water content:** A decrease in water content in the solvent (aqueous solution) decreases the energy loss associated with vaporizing water (during CO<sub>2</sub> stripping at high temperatures) and increases the CO<sub>2</sub> carrying capacity of the solvent.
- Other desirable characteristics of the solvent:**
  - Low CO<sub>2</sub> equilibrium backpressures at absorption conditions
  - Easy reversible reactions at regeneration temperatures
  - Low volatility of the solvent
  - High resistance of solvent to oxidative and thermal degradation

A multitude of chemical solvents have shown varying degrees of success, including amine-based (primary/secondary/tertiary/hindered), non-aqueous solvent (NAS), carbonate-based and phase change. While primary and secondary amines (such as MEA, DGA, AEE, DEA) have higher reaction rates and lower CO<sub>2</sub> carrying capacities, tertiary, and polyamines (such as MDEA and piperazine) have lower reaction kinetics and higher CO<sub>2</sub> carrying capacities. Due to competing characteristics, often blends of varying solvent compositions are used to exploit high reaction rates and CO<sub>2</sub> carrying capacity along with lower regeneration loads. Specifically, for MEA based systems, the steam (LP steam at ~3 bar(a)) energy requirement for solvent regeneration can range from 3.6 to 7 GJ/t CO<sub>2</sub>, depending on the system configuration and heat integration. A few of the proven and emerging solvent-based technologies are described below:

#### a) Air Liquide Amine

Both generic and proprietary amine-based solvents are used in the carbon capture solutions provided by Air Liquide. A process flow diagram for carbon capture using Air Liquide's amine-based solvent is depicted in Figure 3-7. The major process units include:

- **Pre-cooler:** cools the feed gas to the desired temperature

- **Absorber:** CO<sub>2</sub> is absorbed in the solvent through a chemical reaction, facilitated by the countercurrent flow of the solvent and the feed gas
- **Regenerator:** recovers the solvent by CO<sub>2</sub> stripping and recirculates the solvent back to the absorber

The proprietary OASE<sup>®</sup> (or former aMDEA<sup>®</sup> patented by BASF) amine solvent is also used apart from generic amine solvents. The main characteristics of the amine-based BASF OASE<sup>®</sup> solvent are as follows:

- **Proprietary composition:** most likely consists of blends of amines (primary/secondary/tertiary/hindered) and activators (heterocycles, primary or secondary alkanolamines, alkylenediamines or polyamines)
- **Solvent stability:** Higher stability than MEA
- **Energy consumption** for CO<sub>2</sub> stripping and solvent regeneration:
  - Significantly lower (2.4 to 2.6 GJ/t CO<sub>2</sub>) compared to MEA (3.6 to 7 GJ/t CO<sub>2</sub>)
  - Similar to piperazine (2.4 to 2.6 GJ/t CO<sub>2</sub>)

**Figure 3-7: Process Flow Diagram of Air Liquide's Amine Based CO<sub>2</sub> Capture**

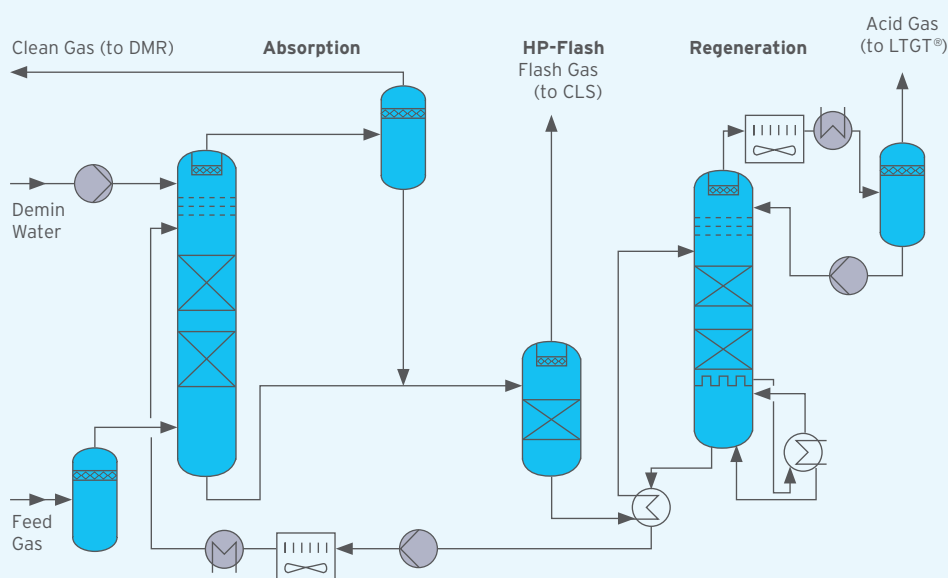

Source: Air Liquide Technology Handbook 2017

**b) ION Clean Energy's Proprietary Amine-Organic Solvent**

In collaboration with the US DOE NETL, ION Clean Energy (ION) has developed a proprietary solvent consisting of a low aqueous amine with an 'organic liquid' as the solvent (instead of water). Due to its lower sensible and latent heats, organic liquid results in a lower thermal regeneration energy duty compared to water. Their system design also includes process modifications such as cold rich gas bypass and intercooling, which further lowers the reboiler duty. A process flow diagram for carbon capture using ION's proprietary ICE-21 solvent is depicted in Figure 3-8. The major process units include:

- **Pre-scrubber:** Removes SO<sub>x</sub>, other harmful gases and most of the particles
- **Direct contact cooling unit:** Controls inlet flue gas temperature and humidity
- **Absorber:** A packed column removes CO<sub>2</sub> using the proprietary ICE-21 solvent through a chemical reaction, facilitated by countercurrent flow of the solvent and feed gas
- **Water wash:** Removes solvent droplets and vapors from the exhaust gas
- **Regenerator:** Recovers the solvent by CO<sub>2</sub> stripping and recirculates the solvent back to the absorber

**Figure 3-8: Process Flow Diagram of a Pilot Slipstream Test Unit at National Carbon Capture Center, USA using ION's Proprietary ICE-21 Solvent for CO<sub>2</sub> Capture**

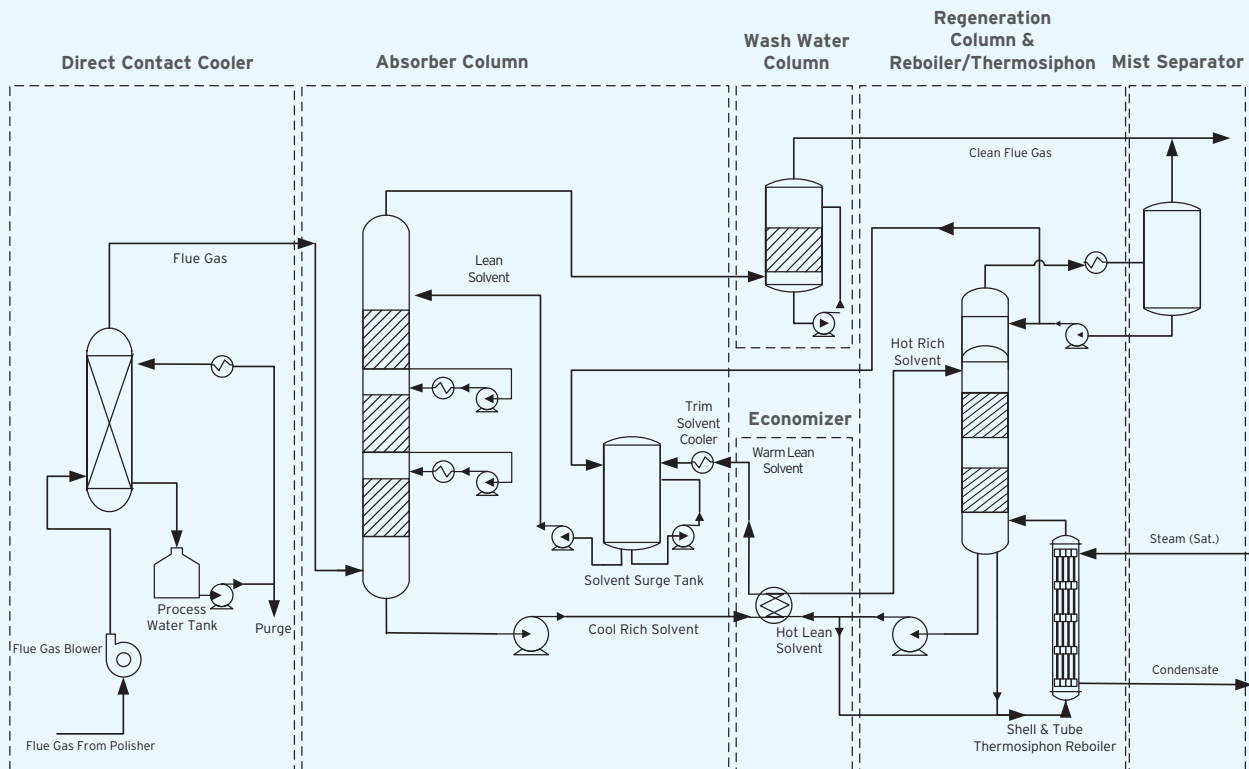

Source: ION Report 2018



The main characteristics of ION's proprietary amine-organic solvent are as follows:

- **Proprietary composition (ICE-21 and ICE-31):** Amine with an organic solvent; low water content.
- **Solvent stability:** Resistant to thermal degradation with low heat stable salt buildup on exposure to SO<sub>x</sub> and NO<sub>x</sub>
- **Energy consumption** for CO<sub>2</sub> stripping and solvent regeneration:
  - Significantly lower (1.6 to 2.5 GJ/t CO<sub>2</sub>) compared to MEA (3.6 to 7 GJ/t CO<sub>2</sub>)
  - Solvent regeneration in flash vessels instead of conventional packed bed stripper columns and reboilers lowers capital costs
- **Solvent recirculation rate:** ~30% lower than MEA for 90% CO<sub>2</sub> capture; lowers capital costs of the pumps, heat exchangers and flash vessels

### c) Kansai Mitsubishi Carbon Dioxide Recovery (KM CDR™)'s Proprietary Amine solvent

The advanced amine-based absorption technology named Kansai Mitsubishi Carbon Dioxide Recovery (KM CDR™) was jointly developed by Mitsubishi Heavy Industries Ltd. (MHI) & Kansai Electric Power Co. Inc. The KM CDR process has historically used the proprietary solvent named the KS-1™ solvent, with the potential to capture over 90% of the CO<sub>2</sub> from a flue gas stream and generate CO<sub>2</sub> with over 99.9% purity. The KS-1™ solvent is an advanced sterically hindered amine.

The development of a new solvent has improved the original KM-CDR process: KS-21™. A process flow diagram for carbon capture using KM CDR's proprietary KS-1™ solvent is depicted in Figure 3-9.

Figure 3-9: Process Flow Diagram of KM CDR CO<sub>2</sub> Capture using Proprietary KS-1 Solvent

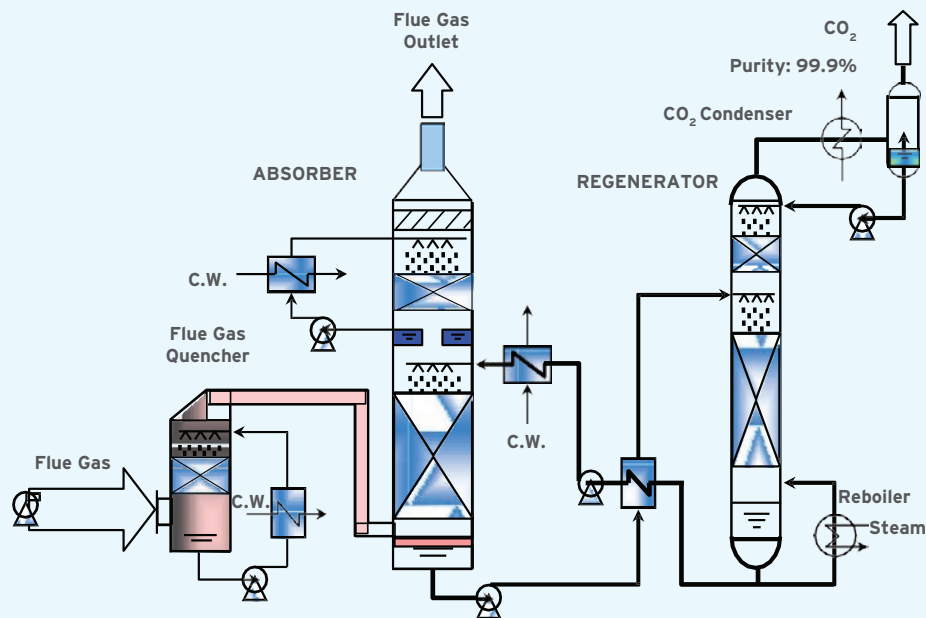

Source: US DOE NETL Compendium of Carbon Capture Technology 2020

The major process units include:

- **Flue gas pretreatment:** Cools the flue gas to the desired process temperature and also enables trim acid gas removal along with gas scrubbing to remove contaminants in a deep polishing scrubber
- **Absorber:** CO<sub>2</sub> is absorbed in the proprietary KS-1™ solvent through a chemical reaction, facilitated by the countercurrent flow of the solvent and the feed gas
- **Regenerator:** Recovers the KS-1™ solvent by CO<sub>2</sub> stripping and recirculates the solvent back to the absorber

The main characteristics of KM CDR KS-21™ solvent are as follows:

- **Proprietary composition:** sterically hindered amine
- Recovery of 95% of the CO<sub>2</sub> from the flue gas
- Low solvent volatility, which reduces the height of the water wash section of the CO<sub>2</sub> absorber
- Improved thermal stability of the solvent allows the regenerator to operate at a higher pressure and temperature
- **Low heat of absorption:** allows high circulation rate and low steam consumption.

- Good resistance to oxidative degeneration that reduces solvent loss

#### d) UOP Solvent Systems

UOP has several solvent-based solutions for CO<sub>2</sub> capture, including Amine Guard™ FS, Benfield™ and SeparALL™. Amongst these, the Amine Guard™ FS is arguably the most widely accepted technology. It uses the proprietary UCARSOL™ chemical solvents (MDEA based), formulated by The Dow Chemical Company. The solvents have a high affinity for acid gas components. UOP Benfield™ uses a chemical solvent that is made up of activated hot potassium carbonate. A process flow diagram for carbon capture using UOP's Amine Guard™ FS solvent is depicted in Figure 3-10. The major process units include:

- **Absorber:** CO<sub>2</sub> absorption in the proprietary UCARSOL™ solvent through a chemical reaction, facilitated by the countercurrent flow of the solvent and the feed gas
- **Regenerator:** Recovers the UCARSOL™ solvent by CO<sub>2</sub> stripping and recirculates the solvent back to the absorber
- **HP & LP flash columns:** Higher pressure operations allow exploitation of flash regeneration

Figure 3-10: Process Flow Diagram of the Amine Guard™ FS CO<sub>2</sub> Capture using Proprietary UCARSOL™ Solvent

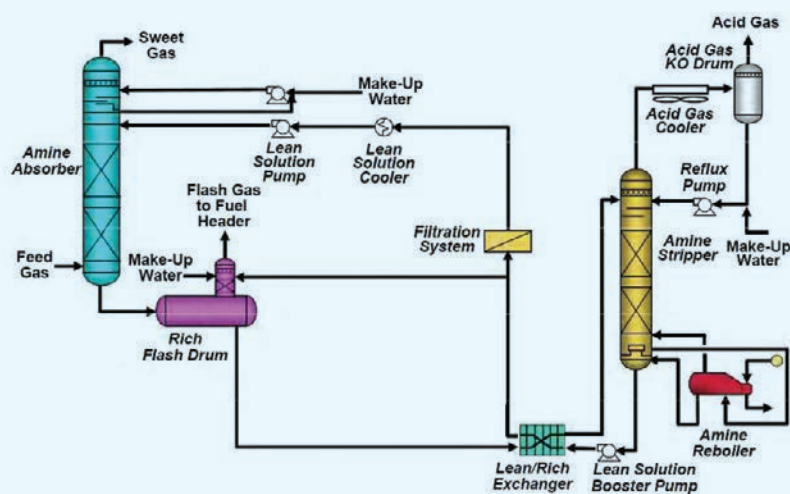

Source: UOP Technical paper

Apart from the conventional flow scheme, other flow schemes are also possible depending on the feed gas

characteristics and final product specifications, as depicted in Table 3-1.

**Table 3-1: Comparison of Various Flow Schemes of UOP Amine Guard™ FS Technology**

Scheme	Configuration quality	Feed gas quality	Desired product	Solvent Cons.	Reboiler duty, MBTU/lb CO <sub>2</sub> removed
<b>Conventional</b>	Absorber + thermal regeneration	Low acid gas (<7%)	50 ppmv CO <sub>2</sub>	Lowest	45-60
<b>Flash only</b>	Absorber + flash column	Very high acid gas (>12%)	>2% CO <sub>2</sub>	Low	8-10
<b>1-stage</b>	Absorber + flash column + thermal regeneration	High acid gas (7-12%)	50-1000 ppmv CO <sub>2</sub>	Higher than flash only	32-40
<b>2-stage</b>	1-stage + semi-lean solvent stream	Very high acid gas (>12%)	500 ppmv CO <sub>2</sub>	Highest	12-18

The main characteristics of the proprietary UCARSOL™ solvent are as follows:

- **Proprietary composition:** MDEA based solvent with low activator concentrations; solvent formulation can be tailored to achieve specific levels of CO<sub>2</sub> absorption. Amine Guard™ II uses inhibitors to increase the alkanolamine strength
- **Fast kinetics:** Activator accelerates the slow overall kinetics of the chemical reaction between CO<sub>2</sub> and MDEA
- **Reduced packing height of absorber column:** Use of an activator facilitates reduced column heights
- **High thermal and chemical stability**
- **Non-corrosive solvent:** No corrosion inhibitors needed
- **No foaming problems**



**e) Baker Hughes Chilled Ammonia Process (CAP)**

A process flow diagram for carbon capture using

the Baker Hughes Chilled Ammonia Process (CAP) is depicted in Figure 3-11.

**Figure 3-11: Process Flow Diagram of Baker Hughes Chilled Ammonia Process (CAP) using Ammonium Carbonate Solvent**

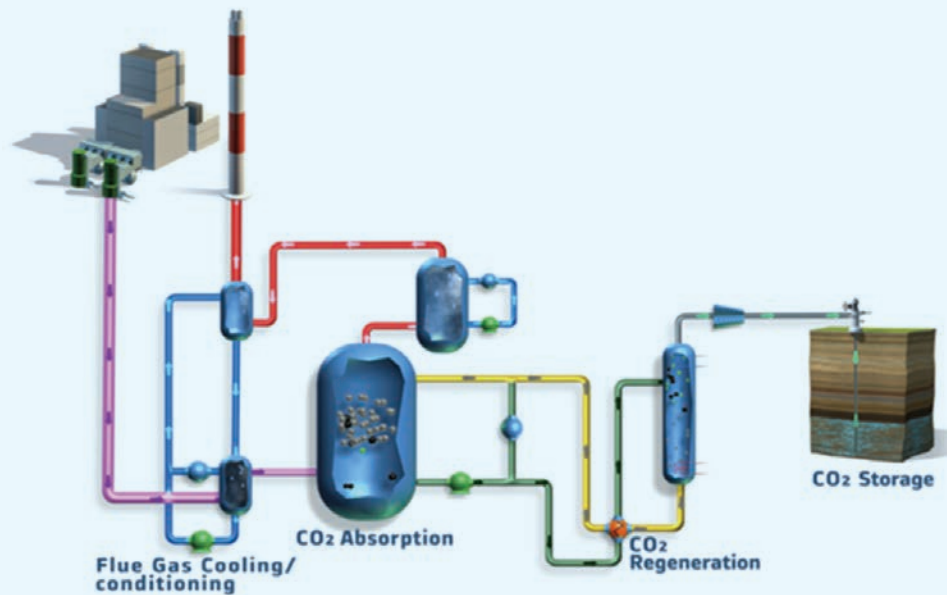

Source: Baker Hughes

An ammonia-based solvent, ammonium carbonate solution, is used for the absorption of CO<sub>2</sub> from flue gas at low temperature in the Chilled Ammonia Process (CAP). The ammonium carbonate solution reacts with CO<sub>2</sub> present in the flue gas to form ammonium bicarbonate. The regeneration of solvent and release of CO<sub>2</sub> from the solution is facilitated by raising the temperature in the regenerator.

The major process units of the CAP include:

- **Flue gas cooling:** Cools the flue gas to the temperature desired for absorption
- **Pretreatment:** for removal of NO<sub>x</sub>, SO<sub>x</sub> and other contaminants to acceptable levels
- **Absorber:** CO<sub>2</sub> is absorbed in the ammonium carbonate solvent through a series of chemical reactions.
- **Ammonia-based chiller system:** Reduces ammonia volatility.

- **Sulfuric acid supply:** Enables reduction of ammonia emissions into the atmosphere to acceptable levels.
- **Stripper:** Recovers the solvent by stripping CO<sub>2</sub> from ammonium bicarbonate solution and recirculates the solvent back to the absorber. The stripping operation can take place at higher pressure as the solvent can tolerate higher temperatures.

The main characteristics of the process include:

- High purity CO<sub>2</sub> and delivery pressure
- Tolerant to oxygen and flue gas impurities
- No degradation of solvent
- No emission of trace contaminants
- Efficient capture of CO<sub>2</sub> (90%)
- Low-cost, globally available reagent

### 3.2.1.2 Physical Solvent-Based Absorption

The major difference between chemical solvent-based capture and physical solvent-based capture is that the latter is favored in cases where the gas stream has a higher partial pressure of CO<sub>2</sub>, such as in gasification, sour gas processing or syngas from SMRs. There is no chemical reaction involved in the capture process as it is guided purely by physisorption. Since no chemical bonds need to be broken for solvent regeneration, the thermal energy penalty is much lower. The regeneration of the physical solvent is achieved by reducing pressure. However, the operating temperatures of physical solvent-based capture processes are much lower (ranging from -70°C to +20°C) compared to chemisorption-based capture, thus necessitating higher power consumption. The two major commercially available physical absorption-based technologies are discussed.

#### a) Rectisol®

In the Rectisol® process, the shifted syngas (after the WGS stage in the HGU) needs to be cooled first and then sent to the absorber column. The physical solvent used for CO<sub>2</sub> absorption is chilled methanol (at sub-zero temperatures). CO<sub>2</sub> is stripped from the CO<sub>2</sub> rich solvent in the stripper and compressed for transportation. The regenerated solvent is recycled and reused in the absorption unit. One advantage of this process route is that water levels in the exit CO<sub>2</sub> rich stream are very low, thus eliminating the dehydration facility requirement. The process flow diagram is depicted in Figure 3-12 below.

Figure 3-12: Basic Process Flow diagram of the Rectisol® Process

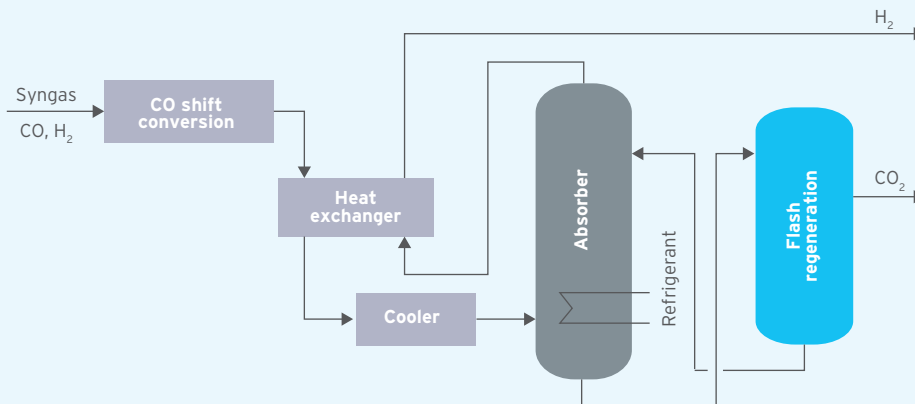

#### b) Selexol™

The Selexol™ process uses a mixture of dimethyl ether of polyethylene glycols (DEPG) and has two variants. The first variant removes all the acid gas components (H<sub>2</sub>S and CO<sub>2</sub>) in one step; the second is a dual-stage process where H<sub>2</sub>S is removed first, followed by CO<sub>2</sub>.

The typical process operating temperature is between 0-20°C, which saves on the refrigeration cost compared to the Rectisol® process. The feed gas is supplied at a pressure of 2-15 MPa with a CO<sub>2</sub> partial pressure of 0.7-3 MPa. A basic process flow diagram of the Selexol™ process is depicted in Figure 3-13.



Figure 3-13: Basic Process Flow Diagram of the Selexol™ Process

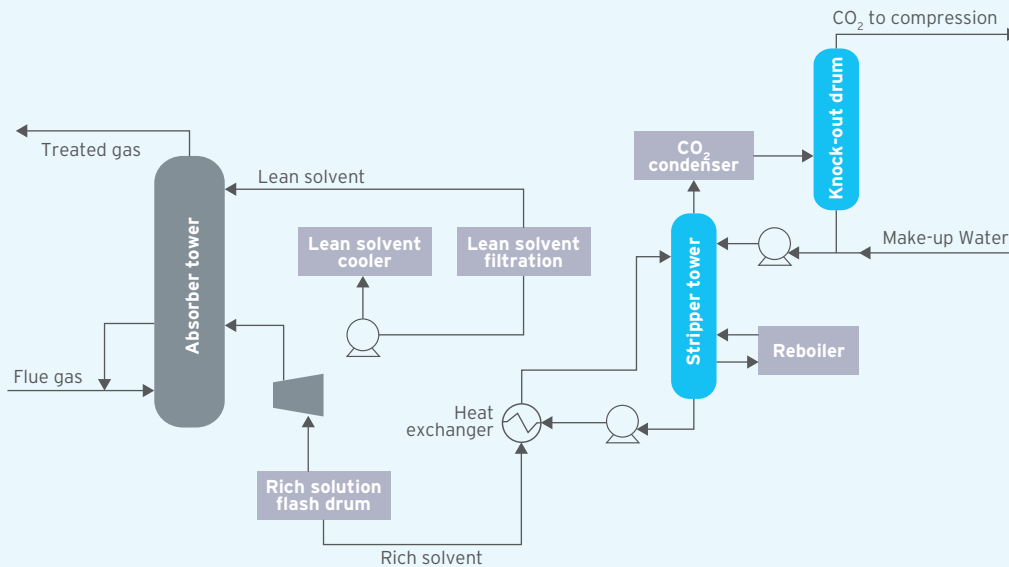

### 3.2.2 Adsorption

In the adsorption-based CO<sub>2</sub> capture process, the CO<sub>2</sub> molecules selectively adhere to the surface of the adsorbent material and form a film, as shown in Figure 3-2 (ii) earlier. This is possible because of the difference in diffusivities and heat of adsorption values for the feed gas stream components.

The working principle of adsorption-based CO<sub>2</sub> capture can be described in three primary steps:

- CO<sub>2</sub> adsorption on the surface of the adsorbent material
- Diffusion of other gaseous molecules through the adsorbent material and exit from the system
- CO<sub>2</sub> desorption by either decreasing pressure or increasing temperature. While the former is known as Pressure Swing Adsorption (PSA), the latter is called Temperature Swing Adsorption (TSA)

Since TSA operations involve high temperatures, it may lead to degradation of the desirable products and reduce the life of the adsorbent material. Since there is no need for heating/cooling in the PSA route, the cycle time is significantly reduced to the order of a few minutes. Hence, adsorption through the PSA route is the preferred choice, allowing the economical removal of a large number of impurities.

The PSA route comprises timed cycles of adsorption, pressure equalization, depressurization, blowdown, purge and re-pressurization across multiple fixed beds. These beds consist of different types of adsorbent materials, such as activated alumina, silica gel, activated carbon or molecular sieves. Few relevant PSA based technologies for carbon capture are described below:



### 3.2.2.1 Air Products Vacuum Swing Adsorption (VSA)

The process flow diagram of the Air Products' VSA technology is depicted in Figure 3-14.

Figure 3-14: Basic Process Flow Diagram of Air Products' VSA Technology

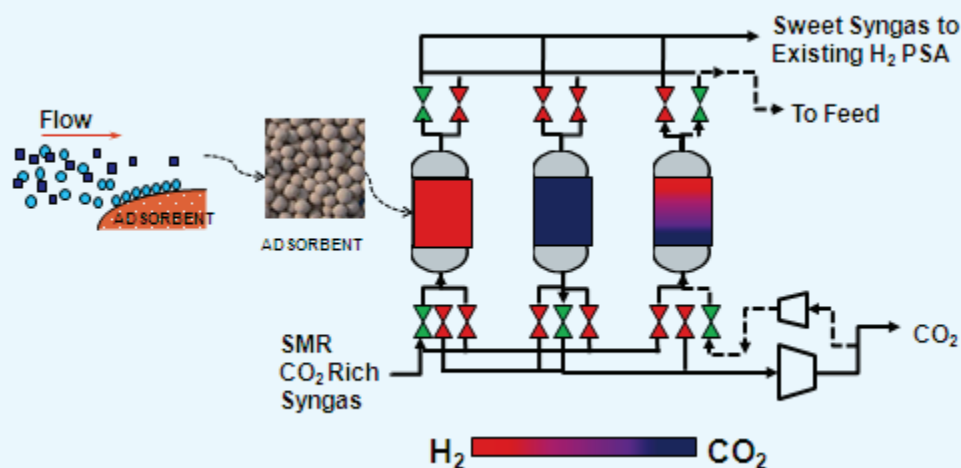

Source: IEAGHG 2018 Report on "The Carbon Capture Project at Air Products' Port Arthur Hydrogen Production Facility"

The various features and steps of the process are outlined below:

- The SMR syngas is cooled in the cold process condensate separator
- VSA vessels (fixed beds) consist of high surface area adsorbent material, on which the CO<sub>2</sub> molecules are selectively adsorbed
- The SMR syngas at high pressure is sent to one vessel for adsorption, while the other vessels undergo low-pressure regeneration
- The H<sub>2</sub> rich sweet syngas (devoid of CO<sub>2</sub>) is sent to the existing PSAs for purification
- A series of pressure equalizations are performed in the VSA vessels at reduced pressures before a vacuum pump removes the CO<sub>2</sub>
- The blowdown gas is taken from the intermediate pressure bed during a 'rinse step'. This gas is compressed and fed to a higher pressure bed to improve the CO<sub>2</sub> recovery

### 3.2.2.2 UOP Polybed™ PSA systems

Typically, a five-step pressure swing cycle is followed in UOP's Polybed™ PSA systems. The steps are shown

schematically in Figure 3-15, where red and blue represent the impurities and the product, respectively.

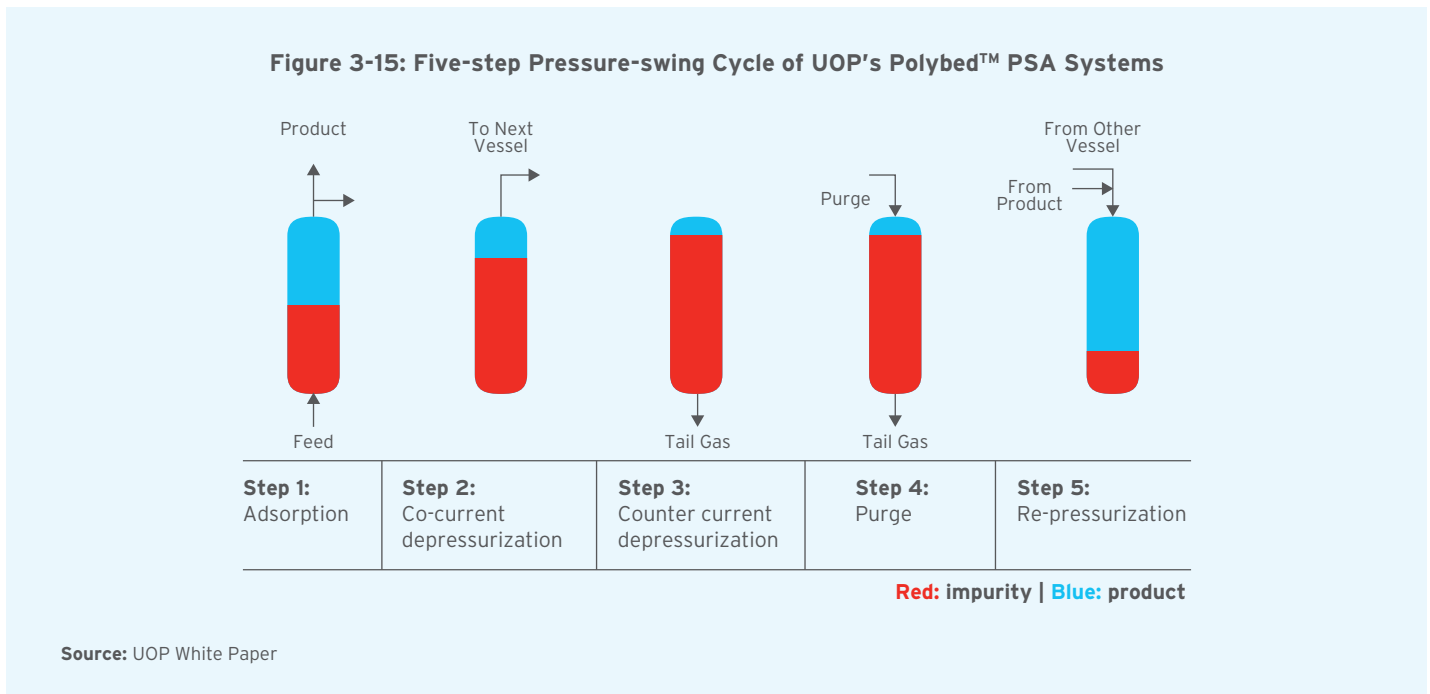

- **Step 1 (Adsorption):** The feed gas (usually flowing in the upward direction) enters an adsorber vessel at high pressure. Once the adsorbent material is saturated, the vessel is taken offline and the feed is automatically switched to a fresh vessel
- **Step 2 (Co-current depressurization):** The adsorbed vessel is co-currently (in the same direction of feed gas flow) depressurized to recover the residual product components. This residual product gas is used internally to repressurize and purge other adsorbers
- **Step 3 (Countercurrent depressurization):** Right after the co-current depressurization step, the adsorbent is partially regenerated by counter-currently depressurizing the adsorber to the tail gas pressure. At the same time, the impurities are rejected
- **Step 4 (Purge):** Further regeneration of the adsorbent is achieved by purging it with a high-purity stream obtained from Step 2
- **Step 5 (Re-pressurization):** On repressurizing (with the gas stream from Step 2 and a slipstream from the product or the feed), the adsorber reaches the adsorption pressure and is ready for the next adsorption step. This marks the completion of the cycle

### 3.2.3 Cryogenic Separation

Cryogenic separation for CO<sub>2</sub> capture is similar to the conventional distillation process, except that it involves the separation of components from a gaseous mixture (instead of liquid) based on the difference in their boiling points. A simple schematic illustration is provided in Figure 3-2 (iii). The feed gas stream is cooled to sub-zero temperatures (lower than -50°C) to separate CO<sub>2</sub> from the other components. Due to the extreme operating conditions of high pressure and low temperature, it is an energy intensive process. The energy consumption can range from 600-660 kWh/t CO<sub>2</sub> recovered in liquid form. Few relevant cryogenic separation-based technologies for carbon capture are described herein.

### 3.2.3.1 Air Liquide's Cryocap™ Technology

The Cryocap™ technology for CO<sub>2</sub> capture is based on the principle of cryogenic separation combined with

membrane separation. The process flow diagram of the Cryocap™ H<sub>2</sub> technology is depicted in Figure 3-16.

**Figure 3-16: Process Flow Diagram of the Cryocap™ H<sub>2</sub> Technology**

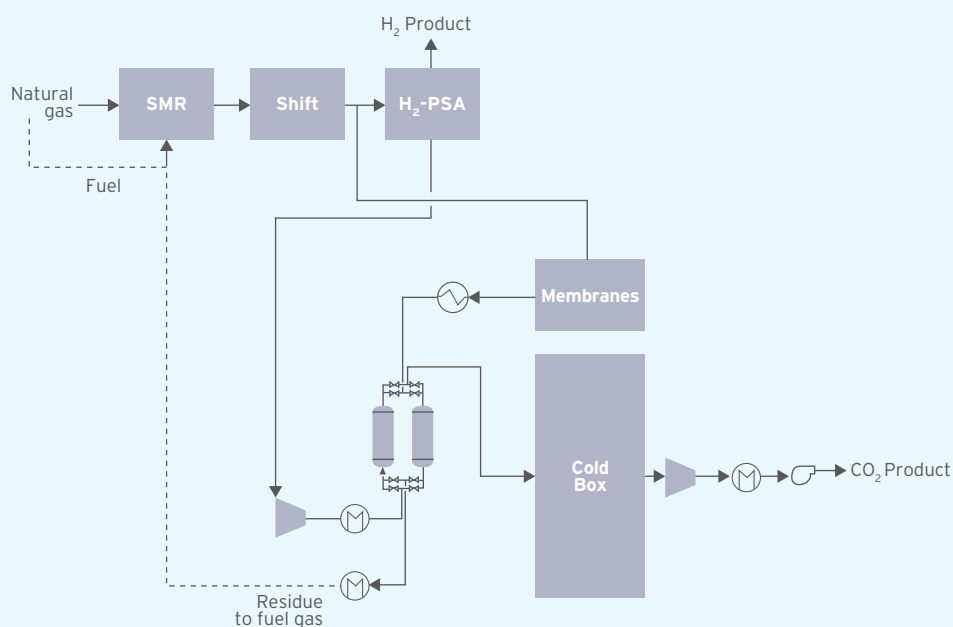

The important features of this technology are listed below:

- A combination of partial condensation and distillation is utilized for CO<sub>2</sub> separation from the other components
- The non-condensed gases are recycled through a membrane system to recover H<sub>2</sub> and CO<sub>2</sub>
- Over 98% CO<sub>2</sub> recovery is possible
- Additional (13 to 20%) H<sub>2</sub> production can be achieved with the same amount of SMR feed i.e. natural gas. The credit of the additional H<sub>2</sub>/savings in natural gas consumption for the production of the same quantity of hydrogen (as the case may be) reduces the overall cost of carbon capture
- The residual gas is utilized as a fuel for the reformer (SMR)
- It is possible to produce food-grade CO<sub>2</sub> by adding

a step of catalytic bed purification to destroy all the remaining hydrocarbons and alcohols

- Lower area footprint is required compared to amine-based systems

### 3.2.3.2 UOP's Ortloff Dual Refrigerant CO<sub>2</sub> Fractionation (DRCF)

- The Ortloff Dual Refrigerant CO<sub>2</sub> Fractionation (DRCF) technology is similar to Air Liquide's Cryocap™ technology. Some of the key features include:
  - Recovery of CO<sub>2</sub> in the liquid state
  - Low energy consumption due to liquid state separation (no need to solidify CO<sub>2</sub>)
  - Additional recovery is possible from the residue gas stream by coupling DRCF with a physical solvent like Selexol™ or membranes
  - Lower area footprint than amine-based systems

### 3.3 R&D in Direct Air Capture

DAC directly captures dilute CO<sub>2</sub> (415 ppm) from the air, and may also emerge as a form of carbon capture, as it has wide applicability and is independent of the source and concentration of the emission stream. DAC is still in its early stages and the economics (present cost of DAC is estimated to range between US\$ 400-800/tonne of CO<sub>2</sub>) and scale of operations are yet to be established. Given the wide applicability of DAC as also the opportunity to remove CO<sub>2</sub> stock from the atmosphere, it is important from a policy perspective to support R&D in DAC technologies.

### 3.4 Microalgae Based Carbon Capture

Microalgae cultivation has piqued the curiosity of the research community for its application in the field of carbon sequestration and further production of various value-added products such as renewable biofuels, bio-fertilizers, bioactive substances, etc. They utilize the sparsely concentrated CO<sub>2</sub> from the atmosphere via Carbon Concentrating Mechanism (CCM) thus are well qualified for CO<sub>2</sub> capture from a more concentrated stream of flue gas. These can be cultivated in saline water systems as well and do not compete with food crops for arable land for cultivation. Due to the faster growth cycle of these microalgae, they can typically entrap 10-50 times more CO<sub>2</sub> compared to terrestrial plants. They can also deacidify the seawater or wastewater used for their cultivation. Owing to these factors, microalgae have been studied for carbon capture and sequestration by several researchers as well as industries around the globe.

The basic philosophy behind the process of carbon capture by microalgae is the use of CO<sub>2</sub> as a nutrient for the cultivation of microalgae. The selected strains of microalgae can be cultivated in ponds or

vertical/horizontal photo-bioreactors. The flue gas stream after removal of traces of heavy metals and other harmful components can be mixed in the ponds/photo-bioreactors, cultivating selected strains of microalgae. The CO<sub>2</sub> will be absorbed by the microalgae and the resulting gas will leave the cultivation system. Selection of appropriate strain of algae and maintaining its growth condition is critical to this process of carbon capture.

The technology is in its nascent stages, with a majority of tests being performed at lab and pilot scales. The capture rate would vary with the climatic conditions, location, algae strain, and other relevant parameters. A demonstration was performed at NALCO's coal-based captive power plant facility in Angul, Odisha in 2017, where algal productivity of 20 tons ac<sup>-1</sup> year<sup>-1</sup> was achieved, leading to a carbon sequestration capacity of 32 tons ac<sup>-1</sup> year<sup>-1</sup>. A simulation based study was also carried out for simulation of algal productivity techno-economic feasibility study for Odisha Power Generation Corporation Limited (OPGC)'s coal-based power plant in Jharsuguda, led by P. Balasubramanian et al. (2019). The maximum average algal productivity achieved in the biophysical model on MATLAB was 111.39 Kg ha<sup>-1</sup> d<sup>-1</sup> enabling CO<sub>2</sub> sequestration of 147.03 Kg ha<sup>-1</sup> d<sup>-1</sup>. This translates to the sequestration figure of 1.32 Kg CO<sub>2</sub>/Kg algal biomass produced in one hectare in a day. The maximum growth varied each month with the highest growth being observed in the month of February. The techno-economic modelling was performed in SuperPro Designer. The study revealed that the production cost came out to be US\$ 58.41/metric tonne of algal biomass. The algal paste could further be sold as a fertilizer which would lead to an evaluated revenue generation. The technology needs to further develop in both upstream (cultivation and harvesting) and downstream (value added products synthesis) stages for commercialization.

### 3.5 Comparative Analysis of Various CO<sub>2</sub> Capture Technologies

Table 3-2: Comparative Analysis of Various Classes of CO<sub>2</sub> Capture Technologies

Process	Working Principle	Advantages	Limitations	Examples
<b>Chemical Solvent</b>	<ul style="list-style-type: none"> <li>Chemical reaction between CO<sub>2</sub> and solvent</li> <li>Governed by rate kinetics &amp; thermodynamics</li> </ul>	<ul style="list-style-type: none"> <li>High absorption at low partial pressure of CO<sub>2</sub></li> <li>Selective capture and high purity CO<sub>2</sub> product</li> </ul>	<ul style="list-style-type: none"> <li>High energy (steam) requirements for solvent regeneration</li> </ul>	<ul style="list-style-type: none"> <li>BASF / OASE®</li> <li>ICE-21, ICE-31</li> <li>KS-1™, KS-21™</li> <li>UCARSOL™</li> <li>CAP</li> </ul>
<b>Physical Solvent</b>	<ul style="list-style-type: none"> <li>Absorption due to CO<sub>2</sub> solubility in the solvent</li> <li>Governed by Henry's Law</li> </ul>	<ul style="list-style-type: none"> <li>Suitable for gas streams with high partial pressure of CO<sub>2</sub></li> <li>Regeneration through low temperature flashing or pressure reduction</li> <li>High absorption capacity &amp; lower solvent recirculation rates</li> </ul>	<ul style="list-style-type: none"> <li>Low energy efficiency for low partial pressure of CO<sub>2</sub></li> <li>High compression requirement for low pressure feed gas</li> <li>H<sub>2</sub>S often absorbed more effectively than CO<sub>2</sub></li> </ul>	<ul style="list-style-type: none"> <li>Rectisol™</li> <li>Selexol™</li> </ul>
<b>Adsorption</b>	<ul style="list-style-type: none"> <li>Selective adsorption due to difference in diffusivity &amp; heat of adsorption</li> <li>Governed by pressure change</li> </ul>	<ul style="list-style-type: none"> <li>Selective capture</li> <li>Can be performed at normal temperatures</li> </ul>	<ul style="list-style-type: none"> <li>Batch process</li> <li>Complex pressure balancing management system</li> <li>High electrical energy consumption</li> </ul>	<ul style="list-style-type: none"> <li>PSA</li> <li>VSA</li> <li>TSA</li> </ul>
<b>Cryogenic Separation</b>	<ul style="list-style-type: none"> <li>Low-temperature separation through liquefaction</li> <li>Governed by temperature change</li> </ul>	<ul style="list-style-type: none"> <li>Selective capture and high purity CO<sub>2</sub></li> <li>Liquefied CO<sub>2</sub> product</li> <li>Food grade CO<sub>2</sub></li> <li>Almost no steam consumption</li> <li>Low area footprint</li> </ul>	<ul style="list-style-type: none"> <li>High energy requirement</li> <li>High operating pressure</li> </ul>	<ul style="list-style-type: none"> <li>Cryocap™</li> <li>Ortloff Dual Refrigerant CO<sub>2</sub> Fractionation (DRCF)</li> </ul>

Summary of the CO<sub>2</sub> capture technology types and applicability to carbon capture:

- **Chemical solvent-based CO<sub>2</sub> capture technologies:** Preferred when dealing with gas streams that are lean in CO<sub>2</sub> and have relatively lower pressures, such as flue gases. The cost and availability of steam is also a key factor as regenerating the solvent requires large quantities of steam.
- **Physical solvent-based CO<sub>2</sub> capture technologies:** These work well on gas streams with relatively higher CO<sub>2</sub> concentration and pressure.
- **Adsorption-based CO<sub>2</sub> capture:** They are suitable for pre-combustion capture, where the gas stream has high pressure and a high CO<sub>2</sub> concentration.
- **Cryogenic CO<sub>2</sub> capture:** Preferred in cases where the cost of power is low. This technology also provides a unique advantage of generating

additional hydrogen without increasing the amount of feedstock (natural gas)/ producing the same quantity of hydrogen with lower natural gas consumption.

The applicability of the various CO<sub>2</sub> capture technologies viz., physical solvent, chemical solvent, adsorption and cryogenic, depends on the project objectives and the project-specific and gas stream characteristics, including:

- CO<sub>2</sub> capture volumes targeted/desired
- CO<sub>2</sub> end usages and CO<sub>2</sub> purity required
- Source gas characteristics (CO<sub>2</sub> concentration, pressure and volumes)
- Availability and cost of utilities such as steam, power, water, fuel, etc.
- Plot availability and space constraints

### 3.6 Summary of Major Large Scale Carbon Capture Commercial Projects

Figure 3-17: Summary of Major Large Scale Carbon Capture Commercial Projects

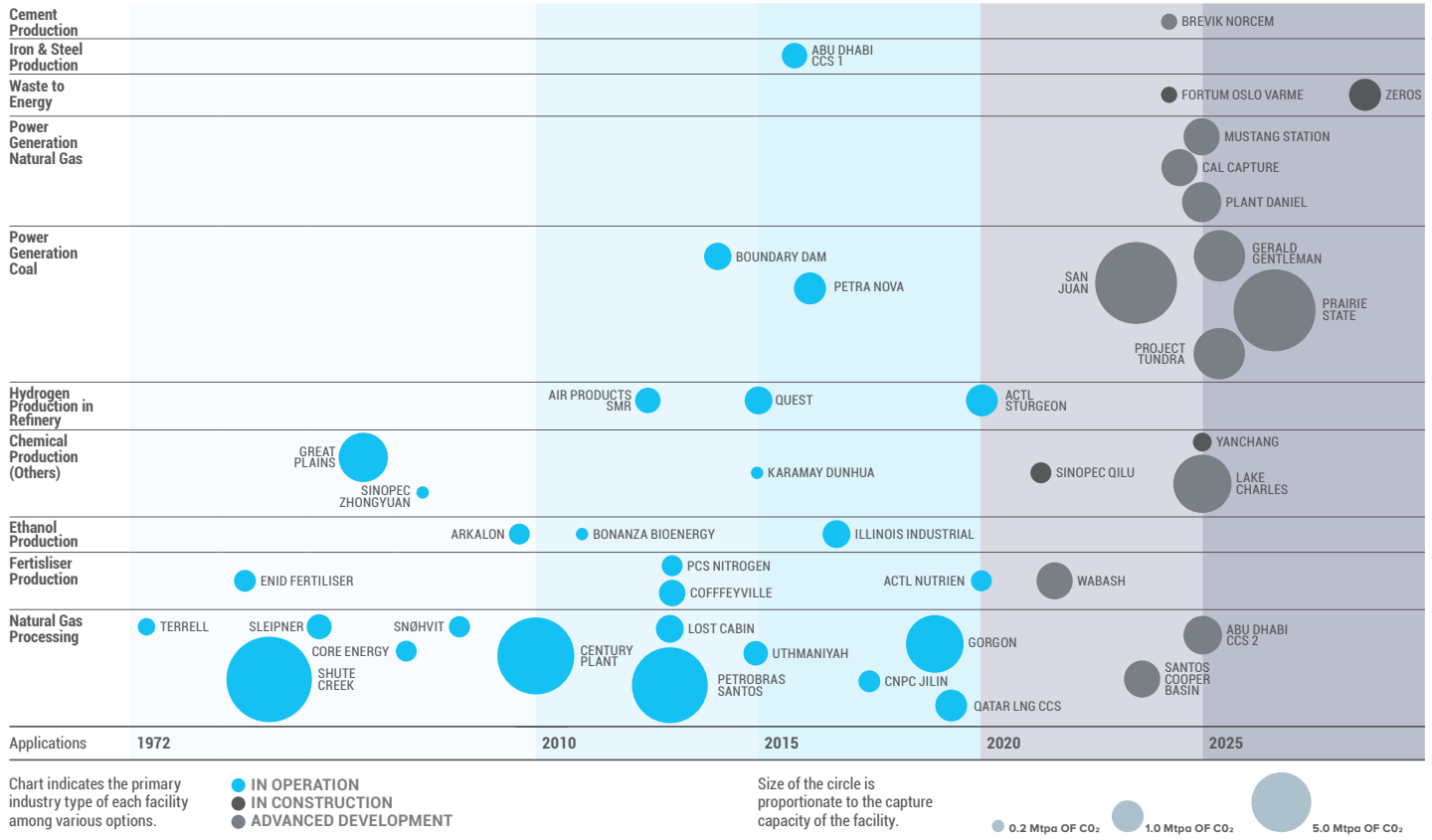

Source: Global Status of CCS 2020 Report

### 3.7 CO<sub>2</sub> Capture Cost Across Processes/Industries

The capital cost and cash costs of carbon capture depends on CO<sub>2</sub> source characteristics (pressure & CO<sub>2</sub> concentration), capture technology, power & steam sourcing costs. Given the trajectory of growing CO<sub>2</sub> emissions in India and the nascent stage of CCUS in India, it is envisioned that by 2030, at least one demonstration scale project carbon capture should be implemented in each of the identified sectors.

The estimated CO<sub>2</sub> capture cost curve for demo scale carbon capture projects in each sector is shown in Figure 3-18. This curve is based on the CO<sub>2</sub> capture potential in each sector, and the typical costs for carbon capture projects, considering Indian costs and conditions. Since the CO<sub>2</sub> source characteristics are generally process-driven, the typical capture cost of

CO<sub>2</sub> (including cash costs & capital charges) has been estimated for a reference plant size for each sector. CO<sub>2</sub> delivery from the plant gate has been assumed at 100 bar (a) for each case.

CO<sub>2</sub> capture cost is the lowest for the gasification process, as carbon capture is already integrated within the process. So, an additional cost of around Rs. 400/tonne of CO<sub>2</sub> is estimated for polishing and compression of the CO<sub>2</sub> stream. The capture costs for other production processes like SMR-based H<sub>2</sub> production, iron & steel, cement, etc. include the costs for gas processing, carbon capture, and compression and are hence higher. Since CO<sub>2</sub> concentration is the lowest for coal-based power plants, the capture cost is the highest out of all major industries.



**Figure 3-18: Cost Curve for CO<sub>2</sub> Capture Across Processes/Industries**

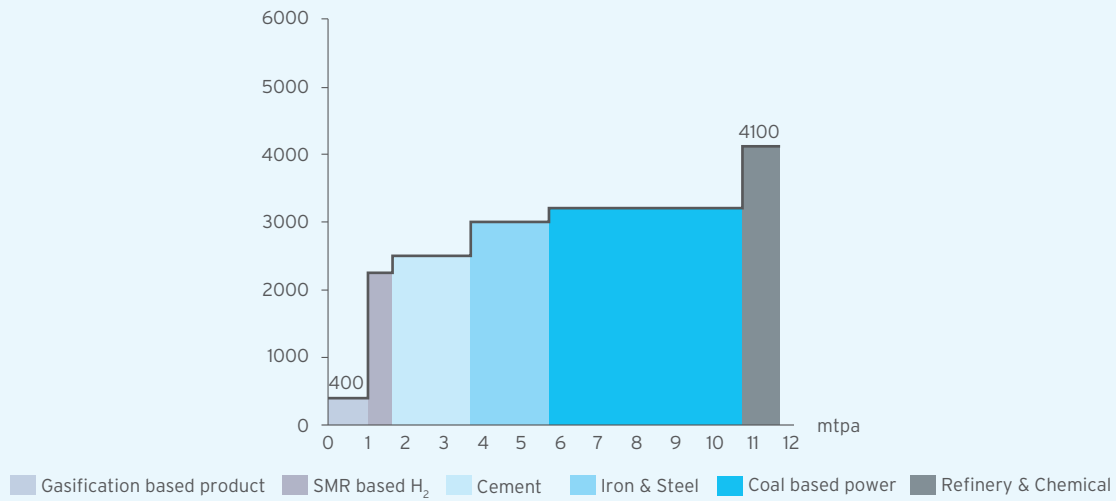

**Note:** The CO<sub>2</sub> capture costs depicted above include costs for capture, conditioning and compression to 100 bar (a) and the amortized capital costs

### 3.8 Overview of CO<sub>2</sub> Utilization Technologies

With the rising interest in CCUS as a decarbonization solution across industries, there is also a need to look at the CO<sub>2</sub> utilization pathways and technologies that

are most appropriate for India. The possible CO<sub>2</sub> utilization pathways are illustrated in Figure 3-19.

**Figure 3-19: Possible CO<sub>2</sub> Utilization Pathways**

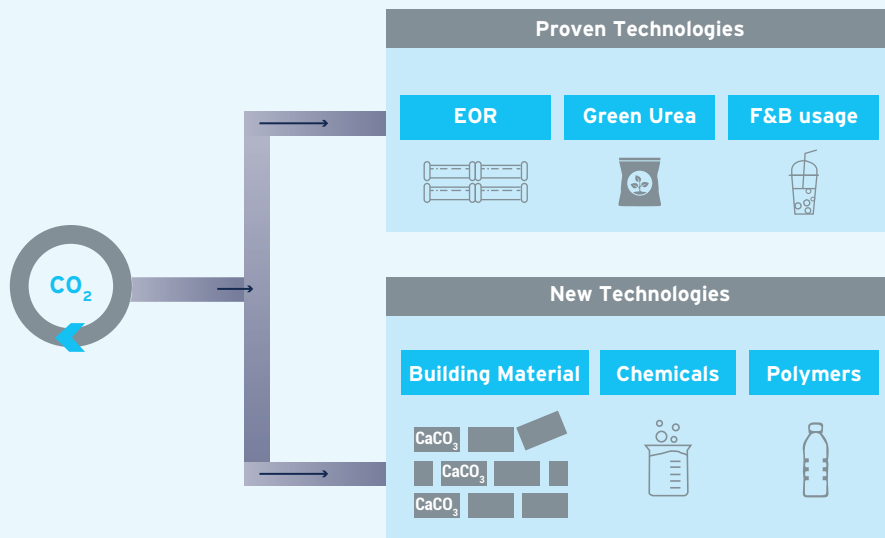

Thways for utilization of the captured CO<sub>2</sub> are primarily EOR, green urea production (conversion of

green ammonia to green urea using the captured CO<sub>2</sub>) and utilization of CO<sub>2</sub> in food & beverage applications.

- (i) **Enhanced Oil Recovery (EOR):** Using CO<sub>2</sub> for EOR has been successfully carried out for decades to produce low-carbon oil from maturing oil fields in North America and other geographies. With Indian oil fields progressing towards their maturity, CO<sub>2</sub> EOR can play an important role in residual oil extraction that is environmentally sustainable and economically feasible.
- (ii) **Green urea:** Urea production from green ammonia can utilize a significant part of CO<sub>2</sub>. India's current production of ammonia and urea is primarily based on imported LNG. So, renewable energy-based ammonia can replace conventional ammonia production with an increased scale of renewables and a competitive cost of green hydrogen production. While renewable-based hydrogen is still in a nascent stage in India, the new green hydrogen policy will boost electrolysis based hydrogen production in the near future.
- (iii) **F&B applications:** The utilization of CO<sub>2</sub> in F&B is in applications such as carbonated drinks, dry ice, and modified atmosphere packing; however,

the scales are quite small compared to the volume of CO<sub>2</sub> generation/emissions.

Additionally, there are other promising propositions for the utilization of CO<sub>2</sub>. The relatively matured CO<sub>2</sub> utilization pathways are:

- (i) **Building material (concrete and aggregates):** A high-level review of the new technologies indicates that utilizing CO<sub>2</sub> for producing building materials (aggregates and concretes) is likely to be the most attractive and feasible option. There is a large market for aggregates and concrete in a developing country like India. CO<sub>2</sub> can be used both during concrete curing and aggregate formation. Since CO<sub>2</sub> is injected in a liquid state without any conversion, relatively little energy is consumed. Moreover, large volumes of alternative feedstock, such as steelmaking slag, are available sources of CaO/MgO which can be utilized to produce synthetic aggregates. The simplified schematic for the CO<sub>2</sub> mineralization process has been illustrated in Figure 3-20.

Figure 3-20: A Simplified Schematic of CO<sub>2</sub> Mineralization Process

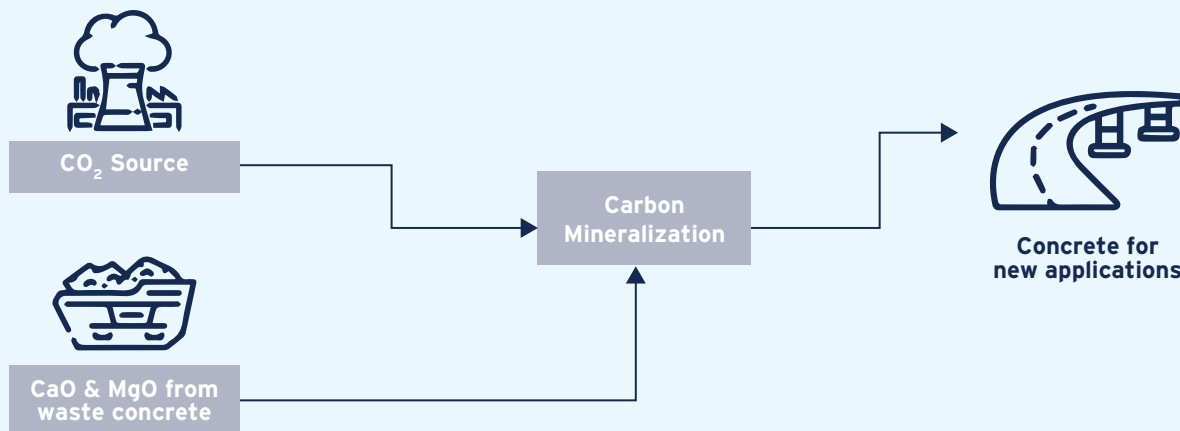

- (ii) **Chemicals (methanol and ethanol):** The production of chemicals such as methanol and ethanol from CO<sub>2</sub> have been proven at commercial scales by various companies around the world. India has ambitious plans for increasing indigenous methanol production capacity and to that extent, the NITI Aayog has also launched 'Methanol Economy' programme. Methanol is a low carbon hydrogen carrier fuel that can support

applications like fuel substitution, as well as an intermediate for the production of various speciality chemicals like acetic acid, MTBE, DME, and formaldehyde which produce essential products like adhesives, foams, plywood subfloors etc. Thus, the proposed methanol economy programme would not only bring down the crude oil import bill and GHG emissions but also can establish a billion-dollar methanol based आत्मनिर्भर economy.

CO<sub>2</sub> hydrogenation process is used to convert the captured CO<sub>2</sub> into methanol. The typical schematic for the CO<sub>2</sub> hydrogenation process along with integration with the carbon capture unit has been illustrated in Figure 3-21. The hydrogenation reaction takes place in the presence of a suitable catalyst.

The major challenges to this technology include sourcing raw materials (H<sub>2</sub>, CO and CO<sub>2</sub>), their capture and conditioning, sourcing clean power for operations, and the conversion process. Some technology suppliers in this field are Carbon Recycling International (CRI), Thyssenkrupp and Mitsui Chemical.

**Figure 3-21: Typical Schematic for the CO<sub>2</sub> Hydrogenation Process along with Integration with Carbon Capture Unit**

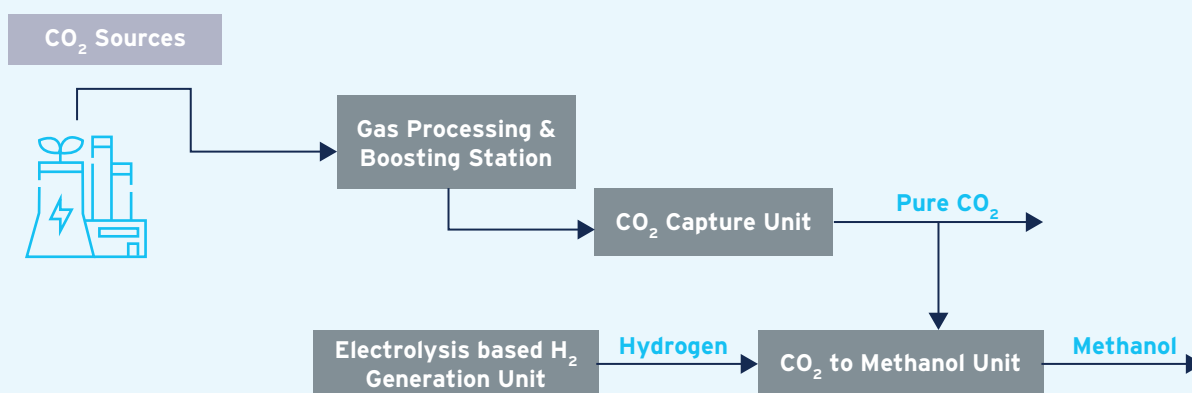



The Government has also set out a target for 20% Ethanol Blend Petrol (EBP) by 2030. Ethanol can be produced by ethylene hydration or biological processes like using H<sub>2</sub>, CO and CO<sub>2</sub> by biological gas fermentation process. Recently, Twelve (a carbon transformation company) and LanzaTech (a biotechnology company) have announced a research and development partnership for CO<sub>2</sub> to ethanol conversion that would eventually aid in scaling up the process to the commercial level. In 2021, LanzaTech and Twelve had also announced plans to develop propylene from CO<sub>2</sub>.

Conversion of CO<sub>2</sub> to methanol and ethanol present attractive opportunities for India. Apart from obvious advantages like reduction in oil import bill and GHG emissions, it would also give boost to commodity production in the country and thus contribute to economic development and job creation.

**(iii) Polymers (including bio-plastics):** The conversion of CO<sub>2</sub> to polymers presents another possible CO<sub>2</sub> utilization route. Various kinds of polymers, such as polyether carbonates, polycarbonates, diphenyl carbonate, cyclic carbonates etc. have been manufactured globally at different scales. However, the polymer product named AirCarbon, produced by the company named Newlight, has found multiple applications (laptop packaging, cell phone casings, furniture, etc.).

The development of new utilization technologies and pathways would enable a circular carbon economy in the country. The need of the hour is to support research development and demonstration (RD&D) of such technologies to establish their viability and aid them in commercialization. The following table summarizes the products, technologies and production scales based on the new technologies for CO<sub>2</sub> utilization.

**Table 3-3: Various CO<sub>2</sub> Utilization Pathways**

Product	Sub-category	Project & Location	Technology Provider	Production Capacity	Quantity of CO <sub>2</sub> utilized
 Building materials	Concrete	San Francisco Bay Aggregates LLC, USA	Blue Planet	33 ktpa (Phase-I)	14 ktpa (Phase-I)
	Concrete	Thomas Concrete, USA	CarbonCure Technologies	1.8 million yd <sup>3</sup>	4500 tpa (across its US operations)
	Lightweight construction aggregates	AVR's Energy from waste plant, Duiven, Netherlands	Carbon8 Systems	100 tonnes of building product (pilot level)	-
	Concrete bricks	Ghent Footpath Construction, Belgium	Carbstone Innovation	Unknown	1 m <sup>3</sup> of carbstone bricks stores a net 350 kg of CO <sub>2</sub>
	Concrete Masonry Unit (CMU)	-	Carbcrete	Unknown	3 kg CO <sub>2</sub> removed per CMU
 Chemicals	Methanol	Shunli CO <sub>2</sub> -to-Methanol plant, China	Carbon Recycling International (CRI)	110,000 tpa	150,000 tpa
	Methanol	George Olah Renewable Methanol plant, Iceland	Carbon Recycling International (CRI)	4000 tpa	5500 tpa
	Methanol	ThyssenKrupp Duisburg Steel Plant, Germany	ThyssenKrupp	Unknown	Unknown
	Ethanol	Beijing Shougang LanzaTech New Energy, China	LanzaTech	60 kt (since May 2018)	100 kt CO <sub>2</sub> (since May 2018)
	Ethanol	Steelanol, ArcelorMittal, Belgium	LanzaTech	80 million litres of bio ethanol (aim)	~1.5 mtpa CO <sub>2</sub> (aimed)
 Polymers	Bio-plastics (AirCarbon)	<ul style="list-style-type: none"> <li>• Dell Latitude series laptop packaging</li> <li>• Sprint cell phone cases</li> <li>• KI plastic chair components</li> </ul>	Newlight	> 23 ktpa	Unknown
	Polyether carbonate	Cardyon mattresses, Germany	Covestro	10 ktpa	Mattresses formed of 20 % CO <sub>2</sub>

### 3.9 Promoting the Adoption of CCUS Technologies in India

The envisaged CCUS policy needs to adopt a multi-pronged approach to promote the adoption of CCUS technologies in India. The key elements of the approach need to incentivize the following:

- i) **Technology transfer:** Carbon capture, CO<sub>2</sub> sequestration and CO<sub>2</sub> EOR technologies are already demonstrated at commercial scale in different parts of the world and particularly in the US for nearly 50 years. Hence the focus for

India should be on technology transfer, assimilation and adoption of such proven technologies (TRL 8 and 9), rather than reinventing the wheel. This would reduce the technology risks, operational risks and costs for CCUS projects in India. Pre-combustion and post-combustion carbon capture technologies (whether solvent, adsorption or cryogenic based) are deployed in commercial scale projects and available from multiple technology providers.

There is an opportunity to engage with such technology suppliers for deploying these proven technologies in demonstration scale projects across different industries, viz. coal-based power, steel, cement, refining & petrochemicals.

The Government of India, through its Department of Science and Technology, may fund such CCUS demonstration projects, with the twin objectives of promoting CCUS projects at demonstration scale, as well as to initiate the process of technology transfer, based on Intellectual Property (IP) use and transfer. The key steps in the technology transfer process, ultimately leading to manufacturing leadership is demonstrated in Figure 3-22 below.



The modalities of the technology transfer could be international collaboration between the suppliers of commercially proven carbon capture technologies and premier Indian engineering consultants for the development and engineering of the Process Development Package and subsequent fabrication & manufacturing of equipment at Indian manufacturing plants, leading to implementation of successful demonstration projects. The collaborating model needs to build in considerations of IP rights transfer/use mechanisms, manufacturing capability and quality, and performance fidelity of operations for transferred technology through

EPC implementation in India. The project structure can also be in the form of a consortium of partners with shared incentives to support the technology transfer and technology suppliers as part of the project consortium. This will drive the incentive to successfully transfer technology while retaining control of the IP of the originating technology partner. This will eventually support the Make-in-India programme, enable technology/IP exports from the originating country, will be less expensive, reduce equipment imports and increase domestic expertise in India.

Government funding for demonstration projects should be through stage gates, with the project partners also contributing to the cost share of the project, typically in the form of in-kind contributions. This kind of model has been successfully implemented by the US DOE for funding carbon capture projects in the US, primarily in the NG based power generation and more recently in other hard to abate industrial sectors. The typical stage gates could be project conceptualization & Pre-FEED, FEED and demonstration of the project, with outputs and parameters being defined at each stage, based on which the funding decision for the subsequent stage is made. A staged approach will also help in developing and detailing the potential technology transfer model, as the details of technology and engineering dependencies across the project life cycle become better defined. It will be necessary to clearly delineate the technology interfaces so that once the project is implemented, the technology performance responsibilities can be assured across the parties.

- ii) **Promoting R&D in novel technologies:** While carbon capture technologies and technologies for CO<sub>2</sub> EOR and sequestration are well developed and implemented at a commercial scale, technologies for the utilization of CO<sub>2</sub> are relatively less developed. Even the relatively more developed technologies for CO<sub>2</sub> utilization such as CO<sub>2</sub> to methanol and CO<sub>2</sub> to aggregates are at TRL levels of 4-5 and 6-7 only respectively. Other promising technology propositions such as CO<sub>2</sub> to synthetic fuels, polymers and novel materials like carbon nano tubes are even further behind on the technology development and deployment curve.

Figure 3-23: Promising CO<sub>2</sub> Utilization Technology Propositions

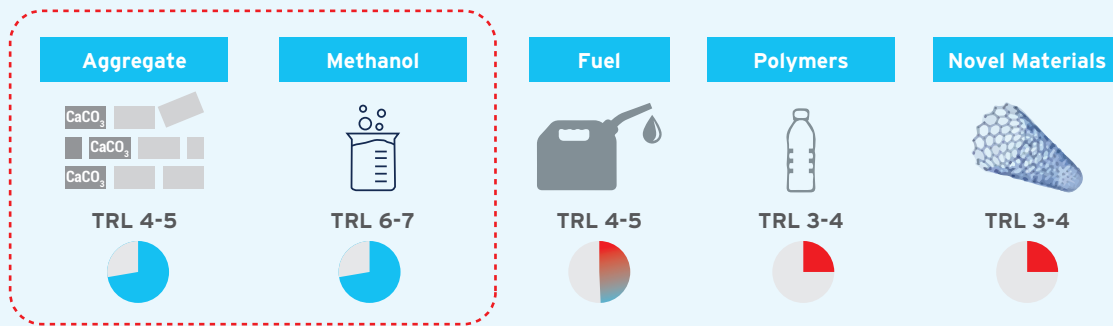

The Government of India should support and promote an ecosystem that promotes and fosters R&D and innovation in the development of CO<sub>2</sub> utilization technologies and also develops new products & applications based on the utilization of the captured CO<sub>2</sub>. The other technology areas to support could be the relatively nascent oxy-fuel combustion, membrane, microbial & algae-based CO<sub>2</sub> capture technologies and calcium looping, which potentially could have a role to play in India's net zero and clean energy transition journey. Similarly, in the area of capture technologies, the Government's policy incentives should encourage R&D in DAC as a possible future option.

These developments are multi-faceted and across different applications, viz. the development of CO<sub>2</sub> to materials, carbon injection, new CO<sub>2</sub> capture technologies etc. and many of the developments are also happening in India through international collaborations and support, such as at the National Centre of Excellence in Carbon Capture and Utilization at IIT Bombay. It is difficult to pronounce a verdict on the developing technologies as innovation and technology development follow their own trajectory. Therefore there is a need to fund, foster and incubate an innovation-based ecosystem, both through national centers of excellence such as the IIT Bombay as well as jointly fund pilot-scale projects with private sector participation.

**iii) Private sector participation:** Private sector participation is quintessential to promote the transfer and commercialization of existing CCUS technologies and also push the envelope for the

development of new and emerging technologies in both capture and utilization. One need not look further than the US DOE or the Build Back Greener programme of the UK Government regarding the institutional frameworks created for leveraging private investments in clean energy and CCUS technology and project development. Early investment and signalling through public/government funding, long term policies to incentivize & de-risk CCUS projects and viable CCUS business models and value chains are needed to encourage and leverage private investment and participation in the development of CCUS technologies and projects. While the funding provided by the US DOE for the development of novel technologies and projects in CCUS is well known, recently the UK Infrastructure Bank has been set-up for promoting the development of new clean energy technologies, particularly for scaling early-stage technologies beyond the R&D phase, where typically more Government support is required. The Bank has initial funding of £12 billion and seeks to pull in private investment to accelerate the net-zero transition in the UK. Similarly in India, governmental institutional frameworks and grants are needed to strategically support new and emerging CCUS technologies, as well as CCUS projects. This will lower the risk for private sector participation and investment, as CCUS scales up and moves to the commercial scale in India. Given the nascent stage of CCUS in India, the Government would need to support the full project/funding cycle, from emerging technologies to part-funding actual CCUS implementations and projects.



## Chapter 4

# Potential for CO<sub>2</sub> Storage in India<sup>2</sup>



## 4.1 Introduction

The end use of the captured CO<sub>2</sub> can be either utilization or permanent storage. Utilization can be done in various areas such as urea manufacturing, conversion to other chemicals (methane, methanol, ethanol), and evolving applications like aggregates. An alternative is the permanent storage of the captured CO<sub>2</sub> in deep underground geological reservoirs like depleted oil and gas reservoirs (for enhanced oil production or EOR), deep saline aquifers, and in basaltic rock formations.

## 4.2 CO<sub>2</sub> Storage Options

For carbon capture at scale, it is important to estimate the CO<sub>2</sub> storage capacity in the geological formations in the Indian subcontinent. This section focuses on the potential CO<sub>2</sub> storage capacities in India for utilization pathways such as EOR (Enhanced Oil Recovery) &

ECBMR (Enhanced Coal Bed Methane Recovery) and permanent storage options like saline aquifers & basaltic storage. In India, exploration activities have been performed with hydrocarbon extraction as the primary target and not CO<sub>2</sub> storage. Thus, the values are theoretical capacities derived from hydrocarbon exploration data available in the public domain. In-depth and detailed studies are required for more accurate CO<sub>2</sub> storage capacity estimation.

### 4.2.1 Enhanced Oil Recovery (EOR)

Oil recovery techniques can be categorized as primary, secondary, and tertiary recovery techniques. Primary techniques rely on natural reservoir pressure and the use of pumps to bring oil to the surface, but the recovery is only about 10%. The secondary techniques involve the injection of water or gas in the reservoir to drive the oil to the production wellbores. This helps in the recovery of 20-40% of the original oil in place. To further improve the production performance of wells, tertiary techniques are used.

Figure 4-1: Working of CO<sub>2</sub> EOR

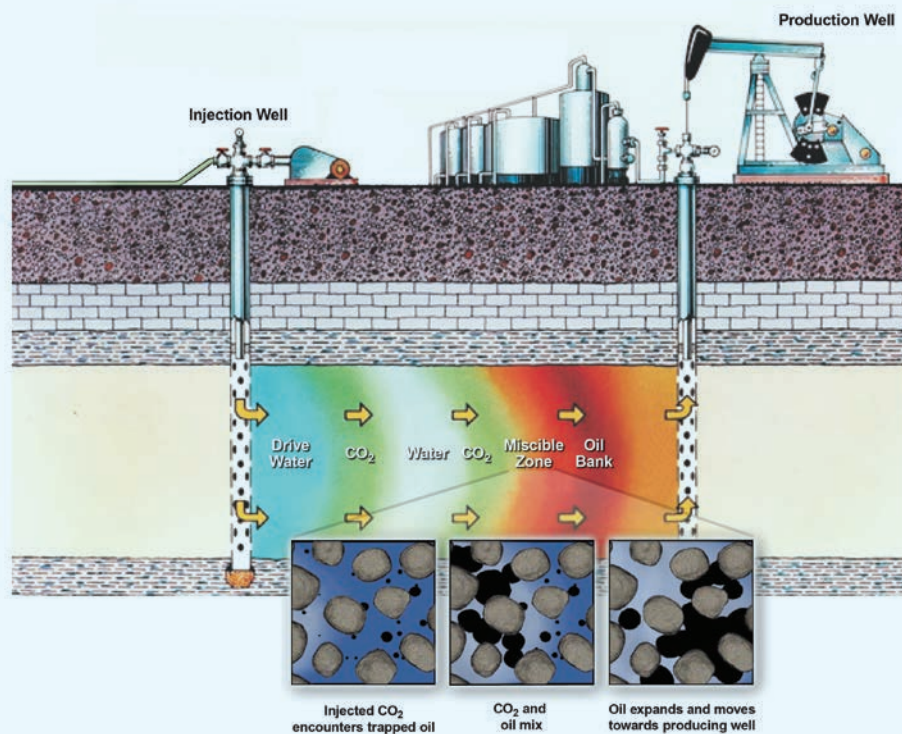

Tertiary techniques of recovery include thermal recovery (steam injection), gas injection (CO<sub>2</sub> injection), and chemical injection (use of polymers or surfactants). These help in the production of 30-60% of the original oil in place.

Injection of CO<sub>2</sub> for EOR has been studied and applied for years, especially in North America. CO<sub>2</sub> is miscible with crude oil which helps in recovering oil not possible by secondary methods. This also helps in permanently storing CO<sub>2</sub> in oil reservoirs, thus making CO<sub>2</sub> EOR a sustainable option for abating CO<sub>2</sub>.

In CO<sub>2</sub> EOR, compressed CO<sub>2</sub> is injected into the reservoir. At high densities, CO<sub>2</sub> is readily miscible with oil. It swells the oil and reduces its viscosity, thereby driving it away from rock formations and towards the production wells. A minimum pressure is required for CO<sub>2</sub> and oil to be miscible. To prevent lower viscosity CO<sub>2</sub> from escaping the reservoir, water and CO<sub>2</sub> are injected alternatively.

#### 4.2.2 Enhanced Coal Bed Methane Recovery (ECBMR)

Coal bed methane (CBM) can be produced from coal seams and can contribute to the energy security of India. In ECBMR, CO<sub>2</sub> is injected into unmineable coal seams under supercritical conditions. The CO<sub>2</sub> injected is accumulated in the coal cleats in a dense gas phase. This CO<sub>2</sub> is adsorbed and absorbed in the coal. Since CO<sub>2</sub> has a higher affinity for coal than CBM, it pushes the coal bed methane towards production wells, thus enhancing its primary recovery. Similar to CO<sub>2</sub> EOR, ECBMR can help in permanently storing CO<sub>2</sub> and the recovered methane can also help offset the cost of carbon capture. This can be a viable option for thermal power plants as many large coal based power plants are located near coalfields. Figure 4-2 gives a pictorial representation of the ECBMR process.

Several pilot tests for ECBMR have been performed across the world, but there is no commercial-scale ECBMR plant (Mazzotti, Pini, & Storti, 2009). Thus, further R&D is required before commercial deployment.

Figure 4-2: Working of CO<sub>2</sub> ECBMR

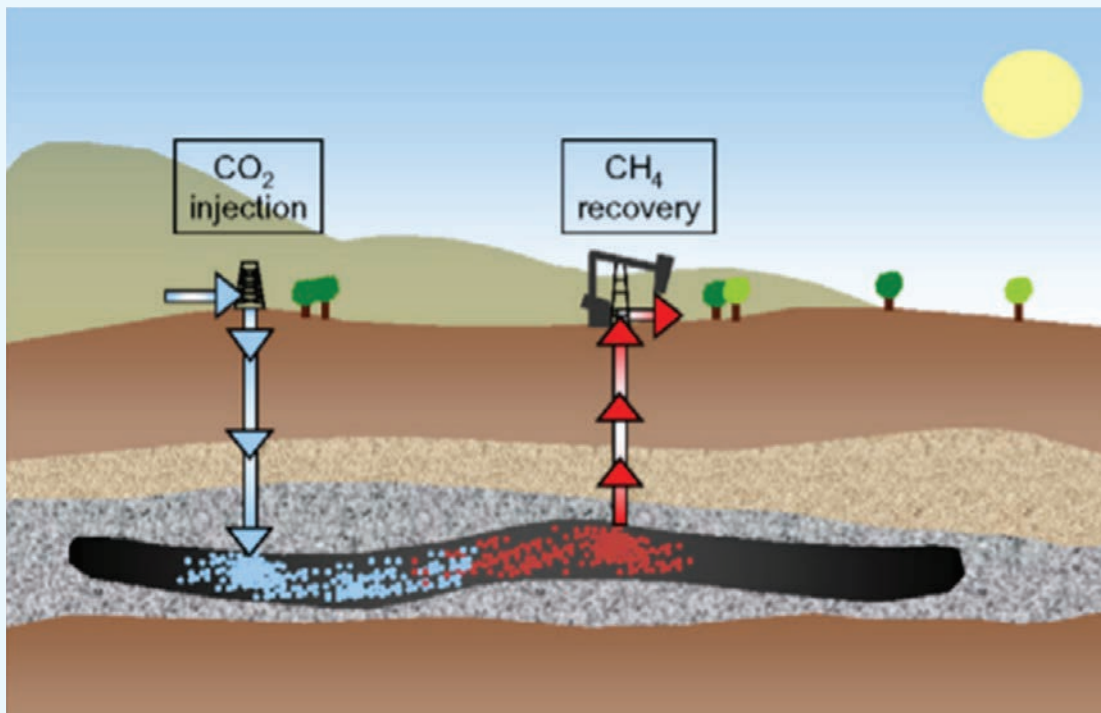



### 4.2.3 Storage in Deep Saline Aquifers

Captured CO<sub>2</sub> can be permanently stored in deep saline aquifers. Unlike EOR and ECBMR, injection of CO<sub>2</sub> in deep saline aquifers has no economic benefit. Deep saline aquifers are spread across very large areas and thus have the potential to store very large quantities of CO<sub>2</sub>.

Deep saline aquifers consist of porous rock formation that contains high quantities of unusable saltwater. The salt/mineral content is very high in this water rendering it unusable for human use. The brine water is called formation liquid and it is trapped by an impermeable rock called the caprock.

Supercritical CO<sub>2</sub> can be injected into the saline aquifers. Brine water has a higher density compared to the injected CO<sub>2</sub>; thus, CO<sub>2</sub> rises towards the caprock and is trapped in the saline aquifer. This is also termed structural/ stratigraphic trapping. While injecting, some CO<sub>2</sub> might occupy the pore spaces by displacing the previously present fluid. This is known as residual trapping. Some of the injected CO<sub>2</sub> also dissolves in the brine. This mixture is denser than the surrounding brine and thus settles down. This is called solubility trapping. CO<sub>2</sub> dissolves in water to form a weak carbonic acid that can react with minerals over time to form solid carbonate minerals. This process is termed mineral trapping.

### 4.2.4 CO<sub>2</sub> Storage in Basalts

Recently studies have been carried out to learn about the CO<sub>2</sub> storage potential of basaltic rocks. Basaltic rock constitutes divalent cations of Ca, Mg, and Fe. They can react with the CO<sub>2</sub> dissolved in water to form stable carbonate minerals and thus can offer a safe CO<sub>2</sub> sequestration method for an extended period.

Compared to mineralization in saline aquifers, basalt rocks offer faster reaction kinetics due to the abundance of iron, calcium, and magnesium oxides. The abundance of basalts on the earth's surface is also a reason for the rising interest in CO<sub>2</sub> storage research and development programmes in basalts. According to calculations done by researchers, the global CO<sub>2</sub> storage capacity of basalts is estimated to be around 8000-41000 Gt of CO<sub>2</sub> (Vikram, Yashvardhan, Debanjan, & Dhananjayan, 2021).

## 4.3 Capacity Assessment for CO<sub>2</sub> Storage

Based on secondary research, the estimated CO<sub>2</sub> storage capacity of India for each of the options discussed above has been presented in this section. Due to the absence of high-level data focused on CO<sub>2</sub> storage, all the capacities presented here are theoretical calculations and estimations. Further work is required to acquire real-time storage data for these options.

Currently, initial storage assessment is being carried out in India. These are focused on the feasibility of CO<sub>2</sub> EOR through seismic, geomechanical, and reservoir studies based on initial surveys by ONGC. Research on the possibility of CO<sub>2</sub> storage in saline aquifers and basalts, predicting and monitoring of CO<sub>2</sub> plume by seismic methods has also been done by some authors. The Technology Information, Forecasting, and Assessment Council (TIFAC), Govt of India, has identified CO<sub>2</sub> EOR and ECBMR as the two immediate pathways for CO<sub>2</sub> sequestration in India (TIFAC, 2018). However, there are no elaborate or dedicated geological, geomechanical or seismic studies 'focused' on country-wide CO<sub>2</sub> storage.

### 4.3.1 CO<sub>2</sub> EOR Storage Capacity Assessment

India has a total of 26 sedimentary basins. The Directorate General of Hydrocarbon's (DGH) 2020 India Hydrocarbon Outlook report divides these basins into three categories, namely category I, category II, and category III basins.

Category I basins are the ones where commercial oil & gas exploration and production activities are ongoing. There are 7 basins in category I. Extensive data for these basins are available due to the exploratory efforts of oil and gas companies. However, these basins have not been explored with the intention of CO<sub>2</sub> storage. Thus, the data of in-place hydrocarbon resources and Ultimate Recoverable Reserves (URR) provided by DGH in the recent exploration assessment has been used with a suitable Recovery Factor for EOR ( $RF_{EOR} = 10\%$ ) to calculate the total pore volume. A conversion factor of 1.165 is used to convert the values of MMTOE to Mm<sup>3</sup>. This pore volume is used along with the formation volume factor ( $B_o$ ) and CO<sub>2</sub>

density at reservoir conditions to calculate the quantity of CO<sub>2</sub> that can be stored in a particular basin. The calculation formulae in equations (1) and (2) are used.

$$V = \text{URR} + (\text{OOIP} \times \text{RF}_{\text{EOR}}) \quad (1)$$

$$M = V B_0 \rho_{\text{CO}_2} \quad (2)$$

The theoretical capacity estimates of the seven category I basins have been listed in Table 4-1.

**Table 4-1: CO<sub>2</sub> EOR Storage Capacity Estimates**

Basin	Storage Capacity (mt CO <sub>2</sub> )
Krishna-Godavari	658.69
Mumbai	1597.24
Assam shelf	667.48
Rajasthan	312.52
Cauvery	99.50
Assam-Arakan	67.01
Cambay	657.25
<b>Total</b>	<b>3402.43</b>

Thus, a total of 3.4 Gt of theoretical storage capacity is estimated to be available for EOR. The Bengal basin has also started producing oil in late 2020, but it has been excluded due to the lack of availability of data about the reserves. The CO<sub>2</sub> EOR capacities are expected to increase as more basins are explored for hydrocarbon production.

### 4.3.2 CO<sub>2</sub> ECBMR Storage Capacity Assessment

Indian coal reserves mostly comprise anthracite and bituminous coal, spread across the Gondwana basin and scattered in some parts of north-eastern India. These coalfields are rich in CBM, and the CH<sub>4</sub> to CO<sub>2</sub> ratio may vary in the range of 1:2 to 1:3. Since several large-scale thermal power plants are located near coal fields, ECBMR presents a promising opportunity for CO<sub>2</sub> utilization and storage.

Information about several parameters is required for a high-level estimation of the CO<sub>2</sub> storage capacity in coal reserves. Since it is difficult to get information about each of these parameters, a few empirical equations have been used to calculate the storage capacity. In the referred work (Vikram, Yashvardhan, Debanjan, & Dhananjayan, 2021), four equations, given by Kim, Ryan, Mavor, and Langmuir, were used to estimate the volume of methane (V<sub>Gas</sub>) present in the coal formations. This volume thus calculated indicates the amount of CO<sub>2</sub> that can be stored in the coal formations using equation (3).

$$Q_{\text{CO}_2} = 3V_{\text{Gas}} \times Q_{\text{coal}} \times \rho_{\text{CO}_2} \quad (3)$$

$Q_{\text{CO}_2}$  is the quantity of CO<sub>2</sub> adsorbed in the coal seam,  $Q_{\text{coal}}$  is the quantity of coal resources and  $\rho_{\text{CO}_2}$  is the density of CO<sub>2</sub> at coal formation depths. The calculations according to the formula of Kim and Langmuir get results close to each other and are considered as appropriate estimations in this study. Kim's formula considers the coal properties and depth of reserve, while Langmuir's formula relies on sorption properties. Mavor's formula was found to be the simplest as it only took ash and moisture content into account. Ryan's formula is dependent on vitrinite reflectance. Based on the above analysis, the results for each coalfield have been tabulated in Table 4-2.

Table 4-2: CO<sub>2</sub> ECBMR Storage Capacity Estimates

Coalfield	Kim (Gt CO <sub>2</sub> )	Ryan (Gt CO <sub>2</sub> )	Mavor (Gt CO <sub>2</sub> )	Langmuir (Gt CO <sub>2</sub> )
Bokaro	0.28	0.32	0.30	0.20
North Karanpura	0.28	0.38	0.35	0.21
Raniganj	0.50	0.59	0.44	0.52
Sohagpur	0.09	0.16	0.19	0.07
Sonhat	0.03	0.06	0.07	0.03
South Karanpura	0.08	0.16	0.13	0.11
Wardha Valley	0.06	0.15	0.15	0.09
Birbhum	0.08	0.14	0.11	0.10
Godavari	0.23	0.53	0.50	0.32
Mand-Raigarh	0.25	0.60	0.53	0.35
Rajmahal	0.16	0.30	0.31	0.13
Singrauli	0.10	0.26	0.29	0.10
Tatapani-Ramkola	0.05	0.08	0.07	0.05
Ib river	0.17	0.41	0.34	0.19
Talcher	0.32	0.80	0.61	0.41
Makum	0.01	0.01	0.01	0.00
Jharia	0.47	0.55	0.41	0.51
Ramgarh	0.01	0.03	0.04	0.01
Auranga	0.02	0.06	0.07	0.03
Hutar	0.00	0.00	0.01	0.00
Daltonganj	0.00	0.00	0.00	0.00
Deogarh	0.00	0.01	0.01	0.00
Johilla	0.00	0.00	0.01	0.00
Pench-Kanhan	0.03	0.06	0.07	0.02
Pathakhera	0.01	0.01	0.01	0.00
Singrauli	0.09	0.23	0.20	0.10
Jhilimili	0.00	0.00	0.01	0.00
Chirimiri	0.00	0.01	0.01	0.00
Bisrampur	0.01	0.02	0.05	0.00
Lakhanpur	0.00	0.00	0.01	0.00
Hasdo-Arand	0.04	0.08	0.10	0.02
Sendurgarh	0.00	0.00	0.01	0.00
Korba	0.06	0.16	0.18	0.06
Kamptee	0.02	0.06	0.06	0.03
Umrer-Makardhokra	0.00	0.01	0.01	0.00
Nand-Bander	0.00	0.01	0.02	0.00
<b>Total</b>	<b>3.5</b>	<b>6.3</b>	<b>5.7</b>	<b>3.7</b>



Based on Kim and Langmuir's formula, the CO<sub>2</sub> storage capacity has been estimated storage to be between 3.5 Gt to 3.7 Gt of CO<sub>2</sub>, respectively. More pilot tests are required to generate data for ECBMR in the Indian context, which would pave the way for the commercial deployment of this technology.

#### 4.3.3 Deep Saline Aquifer CO<sub>2</sub> Storage Capacity Assessment

Indian deep saline aquifers are distributed in the 26 sedimentary basins and are categorized into 3 categories, namely category I, II & III basins. Category I basins have the most detailed lithological data. Additional exploration is needed to obtain high-quality data for category II & III basins.

The CO<sub>2</sub> storage capacity estimation has been done by using the volume of formation being considered for

storage and appropriate storage efficiency factors. The storage efficiency factors account for the dominant lithology of a formation or basin and help in calculating a more accurate capacity. The formula used for calculation has been given in equation (4). The storage capacity estimates for each basin have been tabulated in Table 4-3. Capacity estimation has not been possible for seven basins of category III due to lack of data.

$$G_{\text{CO}_2} = Ah\phi\rho E \quad (4)$$

In the above equation, A is the area covered by the basin, h is the gross thickness of the formation,  $\phi$  is the average porosity,  $\rho$  is the CO<sub>2</sub> density at reservoir conditions and E is the storage efficiency factor that takes area, thickness, porosity, volumetric displacement, and microscopic displacement efficiency into account.

**Table 4-3: CO<sub>2</sub> Storage Capacity Estimation for Deep Saline Aquifers**

Category	Basin	Capacity (Gt)
Category I	Krishna-Godavari	13.39
	Mumbai offshore	9.26
	Assam Shelf	14.16
	Rajasthan	7.34
	Cauvery	16.08
	Assam-Arakan fold belt	32.3
	Cambay	16.13
	Saurashtra	39.74
	Kutch	15.6
Category II	Vindhyan	11.81
	Mahanadi-NEC (North East Coast)	3.25
	Andaman-Nicobar	12.35
	Kerala-Konkan-Lakshadweep	25.33
	Bengal-Purnea	51.58
	Ganga-Punjab	-
	Pranhita-Godavari	6.14
	Satpura-South Rewa-Damodar	1.87
	Himalayan Foreland	-
Chhattisgarh	0.11	
Category III	Narmada	-
	Spiti-Zanskar	-
	Deccan Syncline	-
	Cuddapah	14.24
	Karewa	-
	Bhima-Kaladgi	0.41
	Bastar	-
<b>Total</b>		<b>291.09</b>

The total theoretical storage capacity is estimated to be 291.1 Gt CO<sub>2</sub> for deep saline aquifers. This estimation will increase based upon the availability of more data on the seven category III basins for which calculations could not be done. Deep saline aquifers offer immense storage potential and thus more studies and pilot tests are required to generate the baseline data for CO<sub>2</sub> sequestration operations in India.

#### 4.3.4 Basalt Rock CO<sub>2</sub> Storage Capacity Assessment

Basalt formations in India have been discovered in the Deccan Volcanic Province (DVP) and Rajmahal trap (Vikram, Yashvardhan, Debanjan, & Dhananjayan, 2021). The DVP basalts are spread across the north-western region, covering nearly 500,000 km<sup>2</sup> in area. The volume of these formations is estimated to be close to 512,000 km<sup>3</sup>. A relatively smaller basalt formation is present in the eastern part of India in the Rajmahal traps. This trap consists of 450 to 600 m thick basalt, and spread across an area of 18,000 km<sup>2</sup>.

The CO<sub>2</sub> storage capacity for basalts has been

estimated by using the methodologies used by Sænbjörnsdóttir et al. (Sænbjörnsdóttir, 2014) and McGrail et al. (McGrail, 2006). The formula used for calculation has been described in equation (5).

$$G_{\text{CO}_2} = Ah\phi E_{\text{CO}_2} \quad (5)$$

In the above equation, A is the area of basalt formation, h is the net thickness of formation,  $\phi$  is the average porosity and  $E_{\text{CO}_2}$  is the storage efficiency factor. The methodology used by Sænbjörnsdóttir considers three geothermal systems in Iceland, Krafla, Hellisheidi, and Reykjanes, where the CO<sub>2</sub> content per square meter of surface area was measured. Reykjanes provided the lower limit of CO<sub>2</sub> storage efficiency while Krafla provided the upper limit. McGrail assumed 10 suitable interflow zones, average porosity of 15%, and 1000 m as the targeted depth of injection.

These two methodologies have been applied to Indian basalts to generate the CO<sub>2</sub> storage efficiency factors and, ultimately, the storage capacity estimates. The efficiency factor results and the storage capacity estimates for the two basalt formations of India have been tabulated in Table 4-4.

**Table 4-4: Basalt Formation CO<sub>2</sub> Storage Capacity Estimates**

	Sænbjörnsdóttir et al. (2014)		McGrail et al. (2006)
	Low	High	
Storage Efficiency (Kg/m <sup>3</sup> )	18.8	48.7	40.65
CO <sub>2</sub> Storage Capacity (Gt)			
Deccan Volcanic Province (DVP)	94	243.5	304.88
Rajmahal Traps	3.38	8.77	10.98
<b>Total (Gt)</b>	<b>97.38</b>	<b>252.27</b>	<b>315.85</b>

## 4.4 Overall CO<sub>2</sub> Storage Capacity in India

The overall CO<sub>2</sub> storage capacity assessment for the four options discussed above has been summarized in Table 4-5.

**Table 4-5: Theoretical CO<sub>2</sub> Storage Capacity in India**

Storage Pathways	Theoretical Storage Capacity (Gt)
EOR	3.4
ECBMR	3.5-3.7
Deep Saline Aquifers	291
Basalts	97-315
<b>Total</b>	<b>395-614</b>

EOR and ECBMR provide relatively low storage capacity in comparison to deep saline aquifers and basalts. However, EOR is a more researched and tested technology in major carbon capture projects across the globe and thus can be probably more easily

implemented in the Indian scenario. ECBMR requires more dedicated studies and pilot tests for the Indian coal beds since no commercial-scale project is active in the world.

Deep saline aquifers offer great CO<sub>2</sub> storage potential for India. Since waste material injection is not an industrial practice in India, data related to storage in deep saline aquifers is not readily available. Thus, characterization of the various onshore/ offshore saline formations and improving the quality of data available should be part of future studies for saline aquifers. Based on the recommended CCUS cluster framework, field/basin-specific studies need to be undertaken for regions of higher priority. The pilot tests will further help in preparing baseline data for the development of commercial-scale injection of CO<sub>2</sub> in saline aquifers. Basalt formations are concentrated in the western part of the country and offer a good storage option for emitters in the western states of India like Maharashtra, Gujarat, and parts of Madhya Pradesh. Some basalts are also found in Eastern India in the Rajmahal traps. Further studies are required to get a better understanding of storage mechanisms in these traps. Pilot tests need to be carried out to further develop the industrial CO<sub>2</sub> sequestration framework and infrastructure.



## 4.5 CO<sub>2</sub> Storage Capacity in India - Earlier Work and Future Work

### 4.5.1 Assessment by the British Geological Society

Some of the earliest work done with regard to the assessment of the potential of CO<sub>2</sub> storage in geological reserves in India was done by the British Geological Society (BGS). The BGS report submitted in 2008, covered the Indian subcontinent (India, Pakistan, Bangladesh and Sri Lanka) and was commissioned by the International Energy Agency Greenhouse Gas R&D Programme. The potential geological storage sites were divided into three categories. The categories, along with the estimated CO<sub>2</sub> storage capacity, is given below:

- Oil fields - 1 to 1.1 Gt
- Coal seams - 0.345 Gt
- Saline water-bearing reservoir rocks - 142 Gt

Thus, the total CO<sub>2</sub> storage capacity estimated was 143 Gt, which is a significant number considering the annual CO<sub>2</sub> emissions in India of 2.6 Gt. However, the BGS study did not consider the potential CO<sub>2</sub> storage capacity in basaltic rock formations due to the relative immaturity of the technology but noted the potential of CO<sub>2</sub> storage in the thick basaltic formations of the Deccan trap and the smaller Rajmahal trap. The BGS study also involved a high-level source-sink mapping based on which the sources in the north-west and

south-eastern coast of India were identified to have good nearby storage potential, whereas the sources in south-east, central and northern India were not found to have good nearby storage potential.

### 4.5.2 Assessment by IIT Bombay

Building on the earlier work of the BGS, an assessment was recently undertaken by Professors Vikram Vishal, Yashvardhan Verma, Debanjan Chandra, Dhananjayan Ashok of IIT Bombay. Their paper "A systematic capacity assessment and classification of geologic CO<sub>2</sub> storage systems in India" has reviewed and applied different methodologies for estimating CO<sub>2</sub> storage capacities in different types of geological formations in India. The study identified four storage pathways with adequate potential for CO<sub>2</sub> storage:

- CO<sub>2</sub> storage in deep saline aquifers - 291 Gt
- CO<sub>2</sub> storage in basalt formations - 97 to 316 Gt
- CO<sub>2</sub> based enhanced oil recovery (EOR) - 3.4 Gt
- Enhanced coalbed methane recovery (ECBMR) - 3.7 Gt

The study also categorized the sedimentary basins of India based on CO<sub>2</sub> storage prospects as well as the feasibility of CO<sub>2</sub> storage; the same is depicted in Figure 4-3.

Figure 4-3: Classification of CO<sub>2</sub> Storage Potential of Sedimentary Basins of India

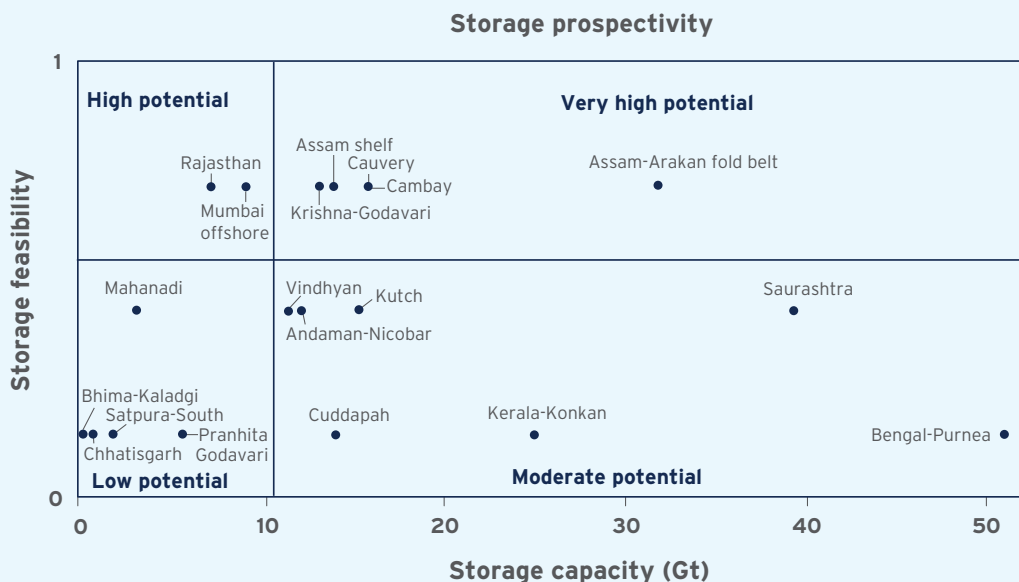

The CO<sub>2</sub> storage potential of the different basins in India is depicted in Figure 4-4.

**Figure 4-4: Major Sedimentary Basins in India with their CO<sub>2</sub> Storage Potential**

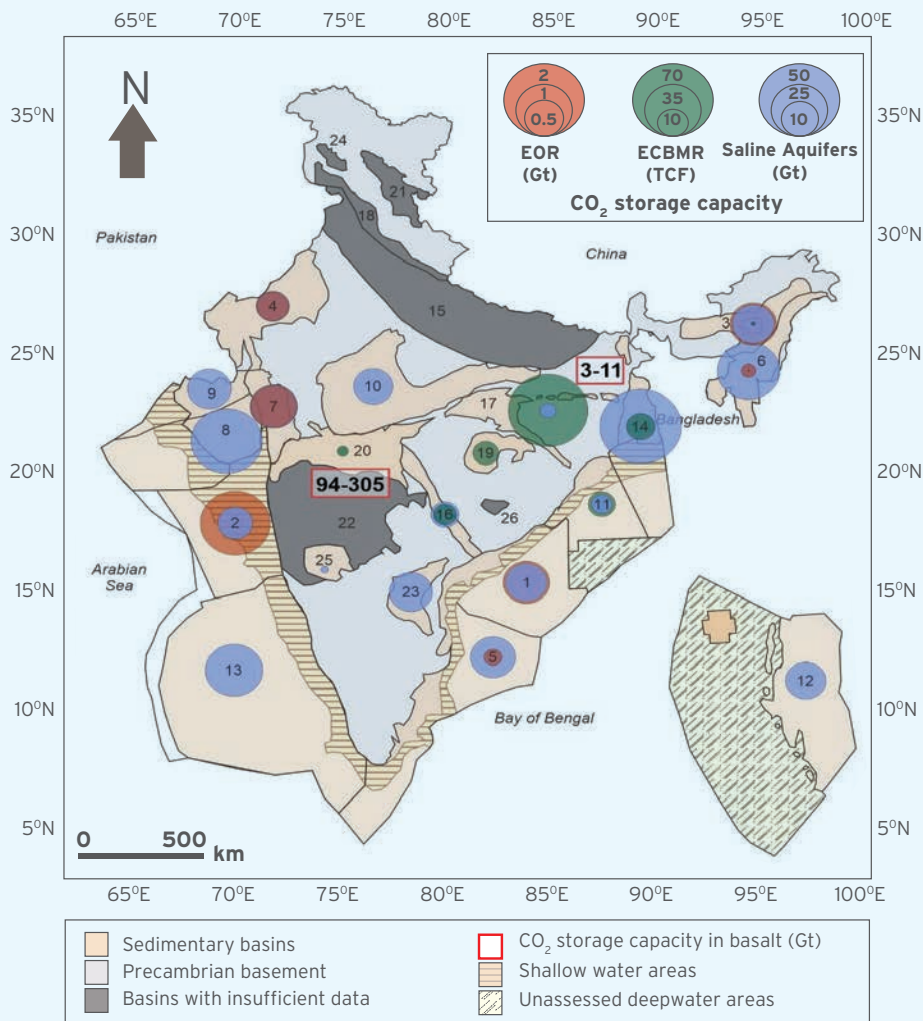

Category-I basins	Category-II basins	Category-III basins
1. Krishna-Godavari	8. Saurashtra	13. Kerala-Konkan
2. Mumbai Offshore	9. Kutch	14. Bengal-Purnea
3. Assam-Shelf	10. Vindhyan	15. Ganga-Punjab
4. Rajasthan	11. Mahanadi	16. Pranhita-Godavari
5. Cauvery	12. Andaman	17. Satpura-South Rewa-Damodar
6. Assam-Arakan Fold belt		18. Himalayan Foreland
7. Cambay		19. Chhattishgarh
		20. Narmada
		21. Spiti-Zanskar
		22. Deccan Syncline
		23. Cuddapah
		24. Karewa
		25. Bhima-Kaladgi
		26. Baster

Although the estimated storage capacity for EOR and ECBMR is relatively smaller, they still offer an attractive option due to the following:

- Provide an option to store CO<sub>2</sub> emissions from nearby large point sources

- Economic value creation through enhanced oil and methane production, thus offsetting part of the CCUS costs
- Availability of exploration data, geological information and infrastructure in existing oil fields and coal fields

### 4.5.3 Future Work Required

Existing studies show enormous CO<sub>2</sub> storage potential in India; however, further actions are needed to make geological storage of CO<sub>2</sub> a reality in India. Some of the key steps which need to be funded/promoted by the Government of India are:

- Source sink mapping to prioritize the regions and basins most opportune for CO<sub>2</sub> storage in terms of storage capacity and feasibility
- Pore space mapping and characterization of the most promising CO<sub>2</sub> storage regions and basins - geological characterization and exploration for CO<sub>2</sub> storage. In the US, the US Department of Energy (US DOE) has funded a network of seven Regional Carbon Sequestration Partnerships (RCSPs) across the country. The aim of the RSCP program is to develop the regional infrastructure of carbon capture and storage across seven identified regions of the US. The seven RSCPs are depicted in Figure 4-5.
- For the prospective regions identified in India, developing the CO<sub>2</sub> storage infrastructure would consist of the following steps:
  - i) **Characterization:** characterization and geological modelling of the prospective regions for assessing the potential to store CO<sub>2</sub> in different types of geological formations.

This would include mapping the large point sources of CO<sub>2</sub> in the region, characterizing prospective sites for CO<sub>2</sub> storage, and ranking the sites for future CO<sub>2</sub> storage projects. The characterization would provide the requisite data for mapping sites to the large CO<sub>2</sub> point sources, develop a better understanding of the CO<sub>2</sub> transportation & storage costs and create a business case for the envisaged CCUS projects.

- ii) **Validation:** undertaking lab-scale field projects in different types of storage fields across EOR, ECBMR, saline aquifers and basaltic formations to gather information about the CO<sub>2</sub> storage sites, and validation of the characterization and modelling work done. This would help in validating the most promising CO<sub>2</sub> storage sites in each region.
- iii) **Commercial-scale Development:** undertake commercial-scale (at least 1 mtpa of CO<sub>2</sub>) CO<sub>2</sub> injection in selected sites. The projects would be optimized through the implementation of an appropriate Monitoring, Verification and Accounting (MVA) framework and risk management measures, and also help in proving the permanence of CO<sub>2</sub> storage in the subsurface and monitoring the extent & movement of CO<sub>2</sub> plume.



Figure 4-5: Seven RSCPs Funded by the US DOE

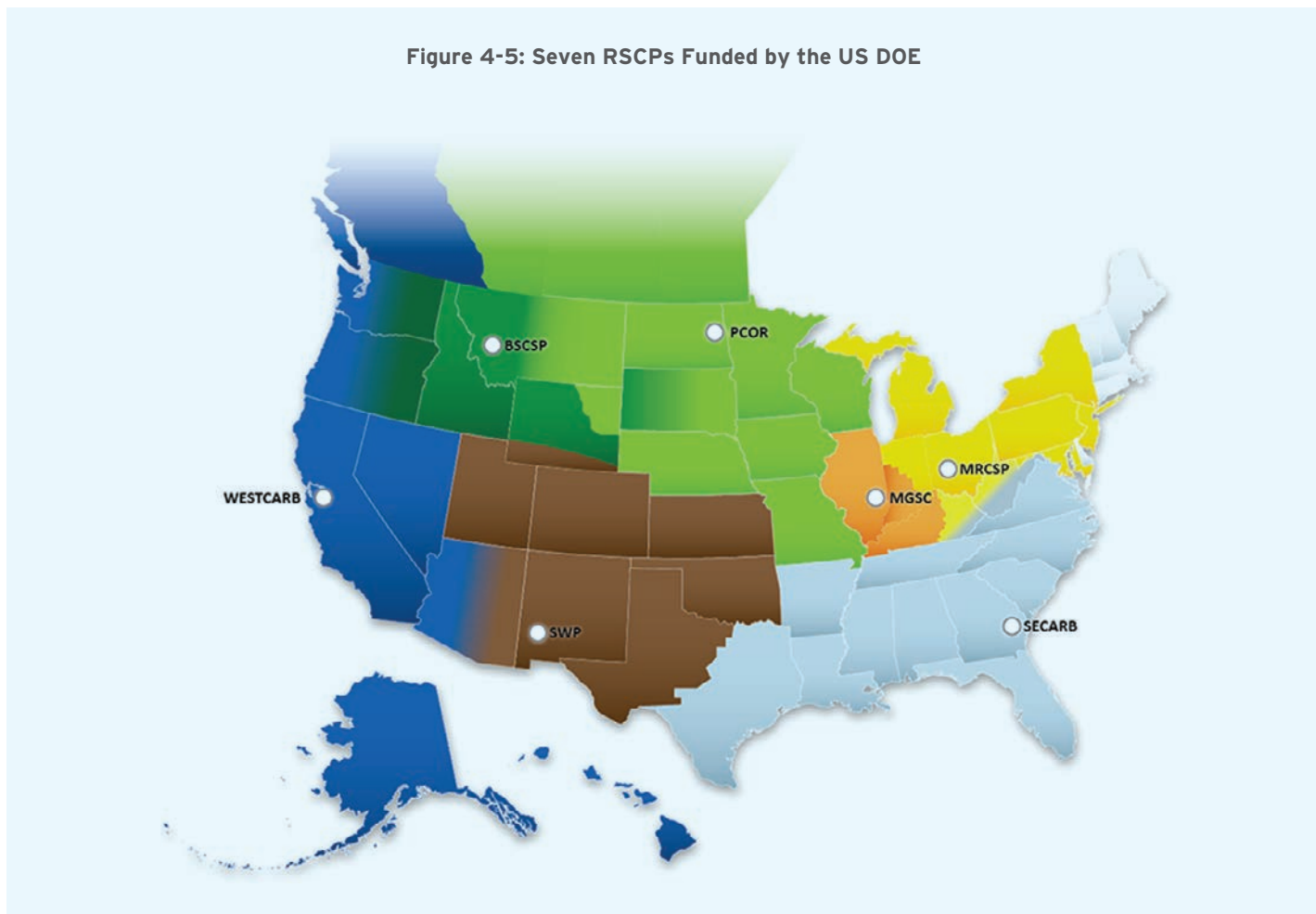

RCSP	Abbreviation	Lead Organisation
Big Sky Carbon Sequestration Partnership	<b>BSCSP</b>	Montana State University Bozeman
Midwest Geological Sequestration Consortium	<b>MGSC</b>	Illinois State Geological Survey
Midwest Regional Carbon Sequestration Partnership	<b>MRCSP</b>	Battelle Memorial University
Plains CO <sub>2</sub> Reduction Partnership	<b>PCOR</b>	University of North Dakota Energy and Environmental Research Center
Southeast Regional Carbon Sequestration Partnership	<b>SECARB</b>	Southern States Energy Board
Southwest Regional Partnership on Carbon Sequestration	<b>SWP</b>	New Mexico Institute of Mining and Technology
West Coast Regional Carbon Sequestration Partnership	<b>WESTCARB</b>	California Energy Commission

Source: US DOE National Energy Technology Laboratory

## 4.6 SECARB

The Southeast Regional Carbon Sequestration Program (SECARB) is one of the prominent RSCPs, setup with US DOE funding for the development and management of CO<sub>2</sub> storage and CO<sub>2</sub> storage infrastructure across 13 south-eastern states of the US. SECARB was set up in 2003 and is managed by the Southern States Energy Board (SSEB). The main goal was to identify major sources of carbon emissions, characterize the geology of the 13 states with respect to CO<sub>2</sub> storage (both EOR and sequestration), identify the most promising sites and sequestration technologies and validate the same through extensive field testing.

The key phases of the SECARB program and accomplishments/developments in each phase are as below:

- i) **Phase I (2003 - 2005):** Phase I focussed on characterizing the geology and CO<sub>2</sub> storage potential of different sequestration options in the SECARB area, based on which an action plan was developed for undertaking small-scale field demonstration of CO<sub>2</sub> sequestration in the subsequent phase of the program.
- ii) **Phase II (2005 - 2010):** During Phase II, three types of small scale field tests were conducted in four locations. These were:
  - a. **Enhanced Oil Recovery:** Ageing oil fields along the US Gulf Coast have an estimated CO<sub>2</sub> storage potential of 31 Gt and are an ideal target for geological storage of CO<sub>2</sub>. SECARB's Gulf Coast Stacked Storage Field Test ran from 2008 to 2015 and was the first RSCP Phase II program to inject more than 500 ktpa of CO<sub>2</sub>.
  - b. **Coal bed methane:** Two field tests were conducted at an existing CNX gas well in Russel County, Virginia and near Tuscaloosa, Alabama.
  - c. **Saline aquifers:** CO<sub>2</sub> injection in saline aquifers was conducted at the Mississippi Power Company's Victor J. Daniel coal-fueled power plant.
- iii) **Phase III (2007 - 2017):** Phase III consisted of two large CO<sub>2</sub> volume storage projects, namely:

- a. **CO<sub>2</sub> EOR at the Cranfield oilfield:** The SECARB "Early Test" ran from 2009 to 2015 and the cumulative volume of stored CO<sub>2</sub> that was monitored during this period was about 5.4 million tonnes. The CO<sub>2</sub> volumes were monitored using a variety of MVA technologies to determine the commercial viability of the project.
- b. **CO<sub>2</sub> sequestration at Citronelle oilfield:** The SECARB "Anthropogenic Test" ran from 2012 to 2014 during which 114 ktpa of CO<sub>2</sub> captured from Alabama Power Company's James M. Barry Electric Generating Plant in Bucks, Alabama was transported (through pipeline) about 19 km and sequestered in a deep saline formation. MVA technologies were applied to monitor the movement of the CO<sub>2</sub> plume in the sub-surface.

The role of both the SECARB Phase III projects in advancing the understanding of CO<sub>2</sub> storage technologies has been recognized internationally and has also helped in the development of international guidance, best practices and standards for carbon capture, transportation, and storage.

The key learning and finding from the SECARB is that once site selection & design, project management and logistical issues are managed, operations of CO<sub>2</sub> storage projects are simple and without any effect or manifestation on the surface. SECARB also demonstrates the criticality of project planning and coordinating the various elements of the CCUS value chain and the importance of site-specific public outreach with local government leaders, community representatives, and sharing details of the project and address their questions & apprehensions about the project risks. The success of the SECARB project has also led to other commercial-scale CCUS projects being constructed in the SECARB area.

The success of the SECARB program demonstrates how Government funding and support can lay the seeds and develop a CCUS value chain. The Government of India may also consider similar programs for the regions that prima facie have good prospects for CCUS, viz. the Krishna Godavari basin, Mumbai offshore, Cambay and eastern parts of the Bay of Bengal basin, especially around Haldia.

## 4.7 MVA (Monitoring Verification and Accounting)

The storage of CO<sub>2</sub> in geological storage sites requires a variety of tools to monitor the volume of CO<sub>2</sub> stored, as well as to prevent CO<sub>2</sub> leakages and releases from the storage sites. These tools are used for monitoring the CO<sub>2</sub> in the atmosphere, near the surface and the sub-surface. The MVA framework provides the tools and approaches required for ensuring the safe, effective and permanent geological storage of CO<sub>2</sub>.

MVA plans are needed for all CO<sub>2</sub> geological storage projects, covering aspects of CO<sub>2</sub> storage, quality control, as well as verification and accounting of CO<sub>2</sub> volumes stored, which would be eligible for earning incentives/credits linked to carbon abatement, viz. the 45Q tax credits in the US. MVA plans need to be developed specific to sites, given the variance of geological conditions across storage sites. Risk management is an important component of the MVA framework for ensuring the safe, effective, and permanent storage of CO<sub>2</sub> across a variety of geologic formations and avoiding CO<sub>2</sub> releases & leakages. It is also important to monitor the location and movement of the CO<sub>2</sub> plume in the subsurface and ensure that the water table is not polluted. In the case of CO<sub>2</sub> EOR, the monitoring and tracking of the CO<sub>2</sub> plume may be easier due to the presence of a number of oil wells; at the same time there is more complexity due to the presence of oil and gas.

The key goals of MVA for CO<sub>2</sub> storage sites are as follows (source: US DOE):

- Improve understanding of the CO<sub>2</sub> storage processes and confirm the storage effectiveness

- Evaluate the reaction and interaction of CO<sub>2</sub> with the formation solids and fluids.
- Assess the likely environmental, safety, and health impacts in case of a CO<sub>2</sub> leakage event and evaluate the remedial actions required.
- Provide a technical basis in case of events such as groundwater impacts, seismic events, crop losses as a result of the CO<sub>2</sub> sequestration.

For any geological sequestration project, the MVA activities are carried out in four phases:

- Pre-Operation Phase:** Project design, establishing baseline conditions, characterization of the site geology and identification of risks.
- Operation Phase:** Period of CO<sub>2</sub> injection in the storage site.
- Closure Phase:** Period of closing and plugging the sites, removal of equipment and facilities and undertaking site restoration. However, necessary monitoring equipment are retained at the site.
- Post-Closure Phase:** Ongoing monitoring is undertaken before making a decision that further monitoring is not required, except in case of any incidents like leakage, or legal cases, for which new information is required about the storage project/site.

Each monitoring phase has specific monitoring tools and techniques to address the specific atmospheric, near-surface hydrologic, and deep-subsurface monitoring needs. These are tabulated below:

**Table 4-6: List of Monitoring Techniques for CO<sub>2</sub> Storage Projects**

Area of Monitoring	Monitoring Techniques
Atmospheric Monitoring Techniques	<ul style="list-style-type: none"> <li>- <b>CO<sub>2</sub> Detectors:</b> Sensors for monitoring CO<sub>2</sub> either intermittently or continuously in the air.</li> <li>- <b>Eddy Covariance:</b> Atmospheric flux measurement technique to measure atmospheric CO<sub>2</sub> concentrations at a height above the ground surface</li> <li>- <b>Advanced Leak Detection System:</b> sensitive three-gas detector (CH<sub>4</sub>, Total HC, and CO<sub>2</sub>) with a GPS mapping system carried by aircraft or terrestrial vehicles</li> </ul>

Area of Monitoring	Monitoring Techniques
<p data-bbox="131 468 302 527"><b>Near-Surface Monitoring</b></p>	<ul style="list-style-type: none"> <li data-bbox="565 279 1495 338">- <b>Laser Systems and LIDAR:</b> Open-path device that uses a laser to shine a beam with a wavelength that CO<sub>2</sub> absorbs</li> <li data-bbox="565 363 1446 422">- <b>Tracers or Isotopes:</b> Natural isotopic composition and/or compounds injected into the target formation along with the CO<sub>2</sub></li> </ul> <hr/> <ul style="list-style-type: none"> <li data-bbox="565 468 1507 493">- <b>Ecosystem Stress Monitoring:</b> Satellite or airplane-based optical method.</li> <li data-bbox="565 518 1438 577">- <b>Tracers:</b> CO<sub>2</sub> soluble compounds injected along with the CO<sub>2</sub>, into the target formation</li> <li data-bbox="565 602 1458 661">- <b>Groundwater Monitoring:</b> Sampling of water or vadose zone/soil (near surface) for basic chemical analysis.</li> <li data-bbox="565 686 1442 745">- <b>Thermal Hyperspectral Imaging:</b> An aerial remote-sensing approach primarily for enhanced coalbed methane recovery and sequestration.</li> <li data-bbox="565 770 1495 829">- <b>Synthetic Aperture Radar (SAR &amp; InSAR):</b> Satellite-based technology in which radar waves are sent to the ground to detect surface deformation.</li> <li data-bbox="565 854 1479 913">- <b>Color Infrared (CIR) Transparency Films:</b> Vegetative stress technology deployed on satellites or aerially.</li> <li data-bbox="565 938 1500 997">- <b>Tiltmeter:</b> Measures small changes in elevation via mapping tilt, either on the surface or in subsurface.</li> <li data-bbox="565 1022 1463 1081">- <b>Flux Accumulation Chamber:</b> Quantifies the CO<sub>2</sub> flux from the soil, but only from a small, predetermined area.</li> <li data-bbox="565 1106 1495 1182">- <b>Induced Polarization:</b> Geophysical imaging technology commonly used in conjunction with DC resistivity to distinguish metallic minerals and conductive aquifers from clay minerals in subsurface materials.</li> <li data-bbox="565 1207 1458 1333">- <b>Spontaneous (Self) Potential:</b> Measurement of natural potential differences resulting from electrochemical reactions in the subsurface. Typically used in groundwater investigations and in geotechnical engineering applications for seepage studies.</li> <li data-bbox="565 1358 1406 1417">- <b>Soil and Vadose Zone Gas Monitoring:</b> Sampling of gas in vadose zone/soil (near surface) for CO<sub>2</sub>.</li> <li data-bbox="565 1442 1490 1467">- <b>Shallow 2-D Seismic:</b> Closely spaced geophones along a 2-D seismic line.</li> </ul>
<p data-bbox="131 1507 277 1566"><b>Subsurface Monitoring</b></p>	<ul style="list-style-type: none"> <li data-bbox="565 1518 1455 1577">- <b>Multi-component 3-D Surface Seismic Time-lapse Survey:</b> Periodic surface 3-D seismic surveys covering the CCS reservoir.</li> <li data-bbox="565 1602 1490 1707">- <b>Vertical Seismic Profile (VSP):</b> Seismic survey performed in a wellbore with multi-component processes. Can be implemented in a “walk-away” fashion in order to monitor the footprint of the plume as it migrates away from the injection well and in time-lapse application.</li> <li data-bbox="565 1732 1451 1791">- <b>Magnetotelluric Sounding:</b> Changes in electromagnetic field resulting from variations in electrical properties of CO<sub>2</sub> and formation fluids.</li> <li data-bbox="565 1816 1487 1875">- <b>Electromagnetic Resistivity:</b> Measures the electrical conductivity of the subsurface including soil, groundwater, and rock.</li> <li data-bbox="565 1900 1474 1925">- <b>Electromagnetic Induction Tomography (EMIT):</b> Utilizes differences in how electromagnetic fields are induced within various materials.</li> </ul>

Area of Monitoring	Monitoring Techniques
	<ul style="list-style-type: none"> <li>- <b>Injection Well Logging (Wireline Logging):</b> Wellbore measurement using a rock parameter, such as resistivity or temperature, to monitor fluid composition in wellbore</li> <li>- <b>Annulus Pressure Monitoring:</b> Mechanical integrity test on the annular volume of a well to detect leakage from the casing, packer or tubing.</li> <li>- <b>Pulsed Neutron Capture:</b> A wireline tool capable of depicting oil saturation, lithology, porosity, oil, gas, and water by implementing pulsed neutron techniques.</li> <li>- <b>Electrical Resistance Tomography (ERT):</b> Use of vertical arrays of electrodes in two or more wells to monitor CO<sub>2</sub> as a result of changes in layer resistivity.</li> <li>- <b>Sonic (Acoustic) Logging:</b> A wireline log used to characterize lithology, determine porosity, and travel time of the reservoir rock.</li> <li>- <b>2-D Seismic Survey:</b> Acoustic energy, delivered by explosive charges or vibroseis trucks (at the surface) reflecting back to a straight line of recorders (geophones). After processing, the reflected acoustic signature of various lithologies is presented as a 2-D graphical display.</li> <li>- <b>Time-lapse Gravity:</b> Use of gravity to monitor changes in density of fluid resulting from injection of CO<sub>2</sub>.</li> <li>- <b>Density Logging (RHOB Log):</b> Continuous record of a formation bulk density as a function of depth by accounting for both the density of matrix and density of liquid in the pore space.</li> <li>- <b>Optical Logging:</b> Device equipped with optical imaging tools is lowered down the length of the wellbore to provide detailed digital images of the well casing.</li> <li>- <b>Cement Bond Log (Ultrasonic Well Logging):</b> Implements sonic attenuation and travel time to determine whether casing is cemented or free. The more the cement which is bonded to the casing, the greater will be the attenuation of sounds transmitted along the casing.</li> <li>- <b>Gamma Ray Logging:</b> Use of natural gamma radiation to characterize the rock or sediment in a borehole.</li> <li>- <b>Microseismic (Passive) Survey:</b> Provides real-time information on hydraulic and geomechanical processes taking place within the reservoir in the interwell region, remote from wellbores by implementing surface or subsurface geophones to monitor earth movement.</li> <li>- <b>Crosswell Seismic Survey:</b> Seismic survey between two wellbores in which transmitters and receivers are placed in opposite wells. Enables subsurface characterization between those wells. Can be used for time-lapse studies.</li> <li>- <b>Aqueous Geochemistry:</b> Chemical measurement of saline brine in storage reservoir.</li> <li>- <b>Resistivity Log:</b> Log of the resistivity of the formation, expressed in ohm-m, to characterize the fluids and rock or sediment in a borehole.</li> </ul>

Source: Best Practices for Monitoring, Verification, and Accounting of CO<sub>2</sub> Stored in Deep Geologic Formations (US DOE NETL)

Examples of successful MVA programs are the MVA programs funded by the US DOE with the goal of demonstrating 95% and up to 99% retention of CO<sub>2</sub> through geological storage by ensuring leakages are contained up to 5% and 1% of the stored CO<sub>2</sub> volumes. The US DOE's Carbon Sequestration Program supports the development of technologies in this domain through the Regional Carbon Sequestration Partnerships (RCSP) Program. Some of the early projects/CO<sub>2</sub> storage sites where the US DOE supported the MVA program are given below. The portfolio of sites was selected to ensure variety in the type and geology of site, CO<sub>2</sub> application, formation depth and porosity, pressure and temperature conditions, to maximize the understanding of the behaviour of the stored CO<sub>2</sub> in different operating and geological regimes.

- i) **Gulf Coast Mississippi Strandplain Deep Sandstone Test in Mississippi:** moderate porosity and permeability storage site
- ii) **Nugget Sandstone Test in Wyoming:** high depth, low porosity and permeability site
- iii) **Cambrian Mt. Simon Sandstone Test in Illinois:** moderate depth, low porosity and permeability site
- iv) **San Joaquin Valley Fluvial-Braided Deep Sandstone Test in California:** high porosity and permeability site
- v) **Williston Basin Deep Carbonate Test in North Dakota:** EOR site

The US DOE also supported the MVA program at the Petro Nova project in Texas for CO<sub>2</sub> capture from NRG Energy's WA Parish Unit 8 (a 640 MW coal fired power plant) and storage in the West Ranch oilfield. The MVA program was conducted by the University of Texas at Austin's Bureau of Economic Geology and consisted of the following components:

- i) **Modeling:** development of a fluid flow simulation model using actual logging and production data
- ii) **Mass balance accounting:** accounting for injected CO<sub>2</sub>

- iii) **Pressure monitoring:** monitoring pressure in 10 dedicated AZMI (above zone monitoring intervals) wells
- iv) **Fluid sampling:** collection of pre-injection fluids (brine, gas, oil) in the injection and AZMI zones
- v) **Groundwater monitoring:** one year of baseline and periodic ongoing sampling of groundwater at several groundwater wells
- vi) **Soil gas monitoring:** characterization of soil gases at several sites
- vii) **Additional monitoring:** additional monitoring of the surface level and downhole pressure by the oilfield operator

CO<sub>2</sub> storage in geological formations (both sequestration and EOR to a limited extent) is the most likely pathway for the disposition of CO<sub>2</sub> at scale, and hence critical to the implementation of CCUS at scale in India, especially for the decarbonization of large emitters of CO<sub>2</sub> such as coal-based power plants. The emissions for a 660 MW supercritical coal based power plant is estimated to be about 4 mtpa of CO<sub>2</sub>. Given the safety concerns about underground CO<sub>2</sub> storage as well as for accounting CO<sub>2</sub> volumes eligible for credits/incentives, it is necessary to develop CO<sub>2</sub> storage demonstration projects and develop robust MVA programs for them. These CO<sub>2</sub> storage demonstration projects should be at identified sites across the different prospective regions in India. In order to develop a holistic perspective, it is also important to implement projects at different types of CO<sub>2</sub> storage sites, such as saline aquifers, basaltic traps and oilfields amenable for EOR. The MVA programs and best practices developed by the US DOE and ISO 14064 & ISO 14065 standards developed for GHG accounting, verification and validation provides a good starting point based on which site specific MVA programs can be developed and implemented.



## Chapter 5

# CCUS Policy Framework for India



## 5.1 Introduction

The key to a successful CCUS policy for India is a framework that supports the creation of sustainable and viable markets for CCUS projects. The framework must consider the fact that the private sector is unlikely to invest in CCUS unless there are sufficient incentives to do so (or conversely penalties from inaction), or unless it can benefit from the sale of CO<sub>2</sub> or gain credits for emissions avoided under carbon pricing regimes. Direct capital grants, tax credits, carbon pricing schemes, operational subsidies, regulatory requirements, and public procurement preference for low-carbon products are some of the policy measures required for CCUS to become a reality in India.

## 5.2 Review of Policy Instruments and Strategies Adopted by Various Countries and Institutions

Local market conditions and institutional factors, such as the current stage of CCUS infrastructure development, emission targets, domestic energy resources and mix, availability and cost of alternative approaches to cutting emissions, all influence the appropriate choice or mix of instruments for each country. The appropriateness of each form of policy instrument varies depending on the CCUS application. Some applications of carbon capture, such as natural gas processing, are well-established and relatively inexpensive and need only minor policy changes. Other applications, such as the CCUS in heavy industries such as steel, are still in the early stages of development. High CO<sub>2</sub> capture costs and their impact on the cost/price and competitiveness of the final product are major hurdles to CCUS adoption. Government support for project developers is key to managing the costs and risks associated with CCUS projects, across the value chain of capture, transportation and storage and establishing and expanding CCUS in a meaningful way in India.

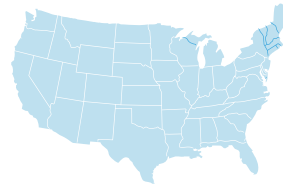

### 5.2.1 USA

The US leads the world in CCUS deployment, with the earliest CCUS projects being implemented in the 1970s. There are 14 operating CCUS facilities in the US, with a combined carbon capture capacity of more than 25 mtpa. The US has heavily invested in CCS R&D since the early 2000s. The US DOE has funded research and development (R&D) in aspects of CCS since 1997 within its Fossil Energy and Carbon Management Research, Development, Demonstration, and Deployment programme (FECM) portfolio. Since 2010, the US Congress has provided USD 7.3 BB\$ for DOE's CCS-related activities, including annual increases in recent years. In 2021, the US Congress provided USD 750 MM\$ to FECM, of which USD 228.3 MM\$ was earmarked for CCUS.

Apart from the DOE funding, CCUS projects received a major fillip in 2009 when the US Federal Government enacted the American Recovery and Reinvestment Act (ARRA), which provided another USD 3.4 BB\$ specifically for CCS projects and R&D activities. Nine individual projects accounted for USD 2.65 BB\$ out of the ARRA funding, with each receiving in excess of USD 100 MM\$. Five out of the nine projects are large scale demonstration projects intended to capture CO<sub>2</sub> from electric power plants. The balance four are in the industrial sector. While some of the projects have faced implementation challenges and delays, the policy intent in USA has clearly focused on developing large scale demonstration plants for CCS through government support and funding. A large number of CCUS projects are under different stages of conceptualization and development, and CCUS is integral to the emission reduction and net-zero commitments of a large number of corporations in different sectors such as coal & NG based power plants, waste-to-energy plants, cement, ethanol facilities, and chemical production.

Some of the key enablers of CCUS in the US are the 45Q tax credits, California's LCFS standards, State Primacy for CO<sub>2</sub> injection and the SCALE Act; these are describe herein:

### 5.2.1.1 45Q

The 45Q provides tax credits for CCUS, starting from USD 12.83 for each tonne of CO<sub>2</sub> utilized for EOR in 2017, linearly increasing to US\$ 35/tonne in 2026. Similarly, for CO<sub>2</sub> captured and geologically stored, the tax credit was US\$ 22.66/tonne in 2017, rising linearly to US\$ 50/tonne of CO<sub>2</sub> in 2026. Post-2026, the credit shall be inflation-adjusted. Few mandatory criteria must be met by emitters in order to avail the tax credit, such as:

- facilities must begin construction before 1 January 2026
- the credit can be claimed over a 12-year period after operations commence
- a minimum volume of CO<sub>2</sub> must be captured and sequestered or utilized, which depends upon the type of the emitting industry, as below:
  - Non-EOR carbon utilization: 25-500 ktpa of CO<sub>2</sub>
  - Industrial and DAC: 100 ktpa of CO<sub>2</sub>
  - Power plants: 500 ktpa of CO<sub>2</sub>

The Global CCS Institute has long hailed USA's 45Q tax credit mechanism as the "most progressive CCS-specific incentive globally". The 45Q credits lower a firm's tax liability; in case there is no tax liability, the credits can be traded in the tax equity market. Tax credits have been successful in spurring renewable energy projects in the US over the last two decades. An important component for the successful implementation of the 45Q or any tax incentive-based system is designing a Monitoring Reporting and Verification framework (MRV) to ensure compliance of the projects seeking the 45Q credits.

The recently enacted Inflation Reduction Act of 2022 has substantially increased the maximum level of credits available from US\$ 50 to US\$85/tonne of CO<sub>2</sub> sequestered and upto US\$180/tonne of CO<sub>2</sub> for DAC.

### 5.2.1.2 California Low Carbon Fuel Standard (LCFS)

The Low Carbon Fuel Standard (LCFS) in California is a trading mechanism aimed at lowering the CO<sub>2</sub> intensity of the state's fuel mix. A CCUS protocol for the LCFS was agreed upon in January 2019, allowing transportation fuels whose lifecycle emissions have been lowered using CCUS to qualify for credits. The

protocol covers a wide range of CCUS applications involving permanent storage of captured CO<sub>2</sub> in depleted oil and gas reservoirs or saline formations or used for enhanced oil recovery in oil and gas reservoirs. Project credits are based on life cycle emission reductions and granted if the reported reductions have been validated.

LCFS is a strong motivator for CCUS deployment in California. In 2020, the carbon credits obtained through the LCFS roughly translated to USD 200 per tonne of CO<sub>2</sub>. While the eligibility standards are strict, several new project announcements have stated that LCFS credits have been considered in their evaluation and analysis of cost economics. The LCFS programme offers several credit-generating possibilities to boost low-carbon fuel supply and usage, viz:

- i) **Fuel pathway-based crediting:** Low carbon fuels generate credits based on emissions reduced compared to the established baseline. These credits incentivize developers to bring more clean fuel options to California.
- ii) **Project-based crediting:** This category includes projects for reducing emissions across the petroleum supply chain using measures such as CCUS and direct air capture.
- iii) **Zero-emissions vehicle infrastructure (capacity-based) crediting:** Installation of hydrogen and fast-charging DC infrastructure can generate credits based on capacity.

### 5.2.1.3 State Primacy for CO<sub>2</sub> Storage

In 2010, the US EPA created the sixth well class (Class VI) specifically to regulate the injection of CO<sub>2</sub> into deep subsurface rock formations. At the time, very few projects were sequestering CO<sub>2</sub> solely to reduce greenhouse gas emissions, but the EPA anticipated that technology development would be key to achieving domestic emissions reductions. Wyoming and North Dakota have been approved by the US Environmental Protection Agency (EPA) to take primary responsibility ('primacy') for regulating CO<sub>2</sub> injection for dedicated geological storage in Class VI wells under the Underground Injection Control (UIC) Program.

Texas and Louisiana have also stepped up efforts to assume regulatory authority for CO<sub>2</sub> dedicated storage. Louisiana has already applied for primacy, based on a

robust CO<sub>2</sub> injection regime in the state and established mechanisms to manage the long-term liability with CO<sub>2</sub> storage. It is expected that owing to their extensive oil and gas industry presence and favourable geology, Texas and Louisiana stand to gain significant carbon storage market share if they can successfully obtain primacy and establish regulatory frameworks that meet EPA’s standards and provide the industry with planning certainty.

**5.2.1.4 SCALE Act**

The SCALE (Storing CO<sub>2</sub> and Lowering Emissions) Act was proposed by a bipartisan coalition in 2021. The Act aims to assist the development of vital CO<sub>2</sub> transit and storage infrastructure to support CCUS and CO<sub>2</sub> removal technologies, as well as regional economic prospects and jobs in the US. The key goals are:

- a. Establishing a CO<sub>2</sub> Infrastructure Finance and Innovation Act (CIFIA) programme to stimulate the development of shared CO<sub>2</sub> transportation infrastructure through flexible and low-interest loans and grants. This federal funding mechanism is aimed to reduce overall costs by enabling economies of scale through interconnected transport systems
- b. Supporting commercial geologic CO<sub>2</sub> storage initiatives with grants.
- c. Promoting CO<sub>2</sub> utilization through legislation

allowing the US DOE to grant financing to municipalities and states to enable procurement of low carbon products and equipment.

- d. Supporting legal and regulatory authorizations for permitting Class VI CO<sub>2</sub> storage wells



**5.2.2 European Union**

The EU has been at the forefront of CCUS technology development and has employed a variety of measures to support, fund and incentivize CCUS. These support measures are in the form of grant funds and legislative & policy initiatives for CCUS, which have been crucial in supporting the CCUS R&D, pilot and demonstration projects across EU countries. A few active funding programmes for CCUS in the EU region are summarized in Table 5-1.

**Table 5.1: EU Funding Schemes for CCUS**

Funding scheme	Objectives	Fund size
<b>EU Innovation Fund</b>	<ul style="list-style-type: none"> <li>- Fund for demonstration of low carbon technologies</li> <li>- Part of the fund allocated to CCUS</li> </ul>	<ul style="list-style-type: none"> <li>- EUR 38 billion support for 2020-2030, depending on the carbon price</li> </ul>
<b>Connecting Europe Facility (CEF)</b>	<ul style="list-style-type: none"> <li>- Supports cross-border CO<sub>2</sub> transportation</li> </ul>	<ul style="list-style-type: none"> <li>- EUR 25.8 billion CEF transport budget</li> <li>- EUR 11 billion budget for cohesion countries</li> </ul>
<b>Recovery and Resilience Facility (RRF)</b>	<ul style="list-style-type: none"> <li>- Mitigate the economic and social impact of COVID</li> <li>- Investment in flagship areas (including CCUS &amp; renewable energy)</li> </ul>	<ul style="list-style-type: none"> <li>- Funds raised by issuing bonds on behalf of the EU</li> <li>- EUR 723.8 billion funds available</li> <li>- EUR 385.8 billion in loans and EUR 338 billion in grants</li> </ul>
<b>Just Transition Fund (JTF)</b>	<ul style="list-style-type: none"> <li>- Support provided to territories facing socio-economic challenges due to climate neutrality transitions</li> </ul>	<ul style="list-style-type: none"> <li>- EUR 19.2 billion fund</li> </ul>
<b>Horizon Europe</b>	<ul style="list-style-type: none"> <li>- Programme supports the R&amp;D and demonstration of CCUS related projects</li> </ul>	<ul style="list-style-type: none"> <li>- EUR 95.5 billion budget for the period of 2021-2027</li> </ul>



The different funding schemes cater to different aspects of technology development. The Innovation fund and Horizon Europe programme specifically focuses on R&D of different low carbon technologies, including CCUS. It also supports the demonstration of these technologies at pilot scale. The Innovation Fund is funded by the revenues collected from the EU Emissions Trading System (EU ETS) and unspent funds from the NER 300 programme. The fund supports both small scale (<EUR 7.5 million capital cost) and large scale (> EUR 7.5 million capital cost) projects.

The CEF was established to support transport networks across Europe, including cross-border CO<sub>2</sub> transportation infrastructure. The REF and JTF are emergency funds deployed to support EU countries transition to climate-neutral solutions in difficult times, like the coronavirus pandemic. This kind of support fund ensures that the countries do not deter from their climate goals in times of crisis.

Horizon Europe (started in 1984) is one of the most significant research and innovation support mechanisms across Europe. It has collaboration with several research bodies and large-scale industries and links them to develop industrial solutions including CCUS. The programme has been responsible for increasing the TRL of several technologies by supporting their demonstration at pilot scale.

The EU has also enacted various policy initiatives to support CCUS technologies and projects. The CCUS Directive of 2009 provides the legal framework for environmentally safe geological storage of CO<sub>2</sub>, ensuring risk minimization from CO<sub>2</sub> storage, such as damage to human health and the environment. The restructured Renewable Energy Directive now supports fuels produced by CCUS.

### 5.2.2.1 EU Emissions Trading System (EU ETS)

The European Union Emissions Trading System (EU ETS) is the world's first GHG emissions trading scheme. The salient features of EU ETS are as follows:

- Applicable for all EU countries, plus Iceland, Liechtenstein and Norway
- Limits emissions from around 10,000 GHG emitters across power and industrial sector, as well as airlines operating between participating countries
- Covers around 40% of the total GHG emissions of the participating countries

- The EU ETS framework has been revised multiple times since its inception in 2005. Presently, the 4<sup>th</sup> trading phase is underway (2021-2030). The legislative framework for this 4<sup>th</sup> phase was revised to ensure emissions reductions in line with EU's 2030 emissions reduction target, i.e., ~40% reduction in GHG emissions by 2030 as compared to 1990 levels
- Follows a 'cap and trade' mechanism, where a cap (or limit) is set on each installation/facility for total permissible GHG emissions, where the cap is reduced over time. Within the cap, installations buy and receive emission allowances (i.e., emissions trading) with each other. The market determines the emissions trading price and hence adds a carbon cost to the industry.

Facilities participating in the EU ETS scheme have reduced their GHG emissions by 35% in 2019, compared to 2005, indicating the success of the scheme. The EU policy support for CCUS is further strengthened by the European Green Deal and 2030 Climate and Energy Framework, wherein CCUS will be an integral tool in achieving the target of reducing net GHG emissions by at least 55% below the 1990 levels and EU becoming the first climate-neutral continent by 2050.

### 5.2.2.2 European Green Deal

The European Green Deal was approved in 2020 and provides a set of policy initiatives aimed at making EU climate neutral by 2050, i.e., no net GHG emissions by 2050. The 2030 GHG emissions reduction target is 55% below 1990 levels. The Green Deal proposes to review existing climate goals and redesign public policies, and also introduce new legislation across EU ETS, energy taxation, energy efficiency, aviation/transport fuel regulations, GHG emissions standards and regulations, land use, forestry and agriculture regulations, creating a social climate fund and carbon border adjustment mechanism. The three main goals of the European Green Deal are:

- Achieve net-zero emissions by 2050 by proposing specific strategies that can help curb emissions across all sectors, with a strong focus on energy, which makes up more than 75% of the total EU-27's greenhouses gas emissions.
- Reduction of the emissions cap allowed under the EU ETS, so that the ETS is aligned to the "Fit for 55" target of 55% GHG reduction by the year 2030.

This is accompanied by the progressive withdrawal of free CO<sub>2</sub> emission allowance for emission intensive sectors, as allowed by the EU ETS

- Introduction of a Cross Border Adjustment Mechanism (CBAM) to prevent carbon leakage and substitution of goods produced in the EU by imported goods from a country with lower or no carbon price or CO<sub>2</sub> abatement requirements. Importers would need to buy CBAM certificates for the embedded carbon emission in their goods, thus creating a level playing field between EU and non-EU (high CO<sub>2</sub> emitting) manufacturers.
- Decouple economic growth from resource exploitation, i.e., GHG emission reductions must happen alongside enhanced resource usage efficiency. This will require technological advancements and fast adoption, rethinking and change in lifestyles, communities and businesses
- Inclusive green transition to alleviate socio-economic impacts of the energy transition. The EU has devised the Just Transition Mechanism (JTM), aimed to provide targeted support to mobilize € 55 billion in 2021-2027 period for the most affected regions

The financing requirement of the European Green Deal is estimated at €1 trillion, and is expected to be financed from the EU budget and EU ETS (50) and the InvestEU programme (balance 50%).

### 5.2.2.3 Norway

Within the EU, member countries, such as Norway have their own individual legislations and regulatory requirements to support the R&D and deployment of CCUS technologies. An example of this is the LongShip ('Langskip' in Norwegian) project which has been successful due to the Norwegian Government's support in terms of economic benefits and stimulus for CCUS.

The LongShip project is a CCS demonstration project in Norway, where annually about 400 ktpa of carbon captured from the Norcem's cement factory in Brevik is transported by tankers to a reception terminal in the west coast of Norway, and then injected into saline aquifer storage formation through pipelines. Northern Lights (a JV of Equinor, Shell and Total) has developed the transport and storage solution, while Norcem developed the carbon capture section. The LongShip project is expected to ramp up CO<sub>2</sub> capture and storage to 1.5 mtpa for 25 years. Two-thirds of the funding requirement of around USD 2.7 BB\$ is expected to be funded from public sources.

The success of the LongShip project is largely owing to the CO<sub>2</sub> transport and storage infrastructure developed by the Northern Lights project. Initially able to store 1.5 mtpa of CO<sub>2</sub> per year, the Northern Lights project has the capacity to increase storage to 5 mtpa of CO<sub>2</sub> per year. Incremental commercial CO<sub>2</sub> volumes can be transported and stored at the Northern Lights facilities, thereby reducing the unit cost of CO<sub>2</sub> storage. However, while LongShip has been hailed as a success, the estimated CCUS cost of €144/tonne (capture costs of €104/tonne and €40/tonne for CO<sub>2</sub> transport and storage costs) is significantly higher than the prevailing EU ETS carbon price as of early 2022. Also, one key risk is the CO<sub>2</sub> leakage from the underground geologic storage, as previous studies at the Sleipner project in the North Sea have shown the potential for significant leaks.

The Norwegian Government also plans to support CCUS projects at waste incineration plants in Bergen, Trondheim and Stavanger. The Government is keen to develop CCS in Waste-to-Energy projects as this has the potential of net removal of CO<sub>2</sub> from the atmosphere, which is vital for achieving the EU's net-zero emission targets by 2050.



### 5.2.3 Canada

Canada has a policy mechanism for supporting its 2030 GHG reduction target of 40% from 2005 levels. Canada also plans to adopt a carbon pricing mechanism, with carbon emission emissions exceeding certain limits to be taxed based on a carbon pricing system, as stipulated by the Greenhouse Gas Pollution Pricing Act (GGPPA) of 2018. The GGPPA defines two separate pricing mechanisms: a) Federal Fuel Charge; and b) Output Based Pricing System (OBPS).

The fuel charge is levied on 21 types of fuel that are produced (including imports) or used or on any waste used for the purpose of generating heat or energy. The fuel charge came into effect in April 2019 and the charge was set at CAD \$ 20 per tonne of fuel. This charge will be stepped up by CAD \$10 every year, till it reaches CAD \$50 in 2022. The fuel charge is levied at the registered distributor level, as they are one of the earliest participants in the supply chain.



The OBPS is a carbon emission performance-based system and is similar to the EU ETS, and brings various industrial sectors under the federal carbon pricing mechanism. A standard level of carbon emission is set for each industry. Plant or facilities emitting more than the limit shall be charged for the additional emissions on a per tonne of CO<sub>2</sub> basis. Plants and facilities that emit less than the set level earn credits, which can be used to offset future emissions or sold to other emitters who have higher emission levels.

This kind of performance-based system incentivizes industries to be energy efficient and limit Scope 1 carbon emissions through CCUS measures. The prerequisites for a plant or facility to be covered under the federal OBPS are that they should have reported emission of at least 50,000 tonne of CO<sub>2</sub>e in 2014 or later and be located in a province following the federal pricing system. The sectors covered in the

OBPS are oil and gas production, mineral processing, chemical production, pharmaceutical production, iron & steel, metal production, mining & ore processing, electricity generation, fertilizer production, food processing, pulp & paper processing and automotive assembly.

The system aims to be revenue neutral, wherein the proceeds from the fuel charge and OBPS is disbursed back to the territories and provinces that have joined the federal system. Provinces or territories that do not join the federal system can formulate their own provincial systems, which meet the minimum national stringency standards or the federal benchmark or be replaced by the federal system. In such regions, the proceeds from the provincial system are to be delivered back to the individuals, families, and businesses through payments and climate action programmes. Table 5-2 shows the carbon pricing system opted for by the different provinces of Canada.

**Table 5 2: Carbon Pricing System Adopted by Different Provinces of Canada**

States	Federal system	Federal cum provincial system	Provincial system
Yukon	✓		
Nunavut	✓		
Manitoba	✓		
Alberta		✓	
Saskatchewan		✓	
Ontario		✓	
Prince Edward Island		✓	
British Columbia			✓
Northwest Territories			✓
Quebec			✓
Newfoundland and Labrador			✓
Nova Scotia			✓
New Brunswick			✓

CCUS development in Canada is concentrated in Alberta and Saskatchewan. Both the provinces have CCUS supportive regulations equivalent to the GGPPA norms. The province of Saskatchewan has entered into an agreement with the Federal Government wherein at least 40% of electricity shall be generated

from non-emitting sources, which would lead to the phasing out of coal based power plants without CCUS. This would also incentivize retrofitting coal-based power plants with CCUS technology to ensure their continued operations.

Alberta has adopted the Technology Innovation and Emissions Reduction Implementation Act (TIER). TIER is a provincial policy measure which sets the CO<sub>2</sub> emission benchmark for emission-intensive industries and a CO<sub>2</sub> price of CAD \$30 per tonne for emissions above the benchmark. Facilities with emissions below the benchmark earn emission performance credits, which can be traded/sold with other regulated authorities. CCUS is an eligible technology for CO<sub>2</sub> emission reduction under TIER. The Government of Alberta has also supported and funded CCUS project development through a CAD 80 MM\$ Industrial Energy Efficiency and Carbon Capture Utilization and Storage Grant Program, for funding up to 75% of project expenses up to CAD 20 MM\$. Grant support has been provided to many CCUS projects such as Boundary Dam (2014), Quest (2015), ACTL-Agrium (2020), and ACTL- North West Sturgeon Refinery (2020). In particular, the ACTL project has received grant support CAD 558 MM\$ from the Government of Alberta and Canada. To address CO<sub>2</sub> storage risks, the Canadian Government has also introduced laws regarding the long-term liabilities surrounding CO<sub>2</sub> storage.



### 5.2.4 UK

The UK Government's decarbonization plans are guided by four main principles:

- no mandates on consumers to replace existing products or infrastructure
- implementation of fair carbon pricing by the Government
- economic assistance to low-income consumers
- incentives to businesses for deploying low-carbon technology

A new element of the UK's policy is the carbon price. In 2021, a new UK Emissions Trading Scheme covering energy-intensive industries, power generation, and certain parts of aviation was implemented. By 2023,

an emissions cap will be implemented for a net zero trajectory and strategy. The aim is to have CCUS projects for capturing 10 mtpa CO<sub>2</sub> by 2030, to be expanded to 20-30 mtpa subsequently. The CCUS deployment goal aims at establishing two CCUS clusters by 2025 and two more by 2030. Clusters would be based on the co-location of coast based industries and electricity generating facilities and CO<sub>2</sub> storage facilities, similar to the approach taken in the United States, Australia and China.

The Climate Change Act of 2008 has mandated the creation of "carbon budgets," which set emissions-reduction objectives in five-year intervals. The UK has nearly eliminated coal based electricity generation, increased industrial and building efficiency, and reduced methane emissions from fossil fuels. According to the most recent carbon budget, the UK will need to collect 47 mtpa of CO<sub>2</sub> per year by 2050 to achieve net-zero emissions. Accordingly, the 2018 CCUS Deployment Pathway Action Plan outlines the targets for addressing policy impediments and establishing market mechanisms for CCUS. The approach is based on industry consultation and identification of viable CCUS business models and supply chains.

The UK government has also invested in R&D and CCUS demonstration projects and has allocated USD 61.2 MM\$ for the same. The UK Government is also supporting the CCUS Innovation 2.0 competition, which pledges USD 26.5 MM\$ in grants to new technologies or processes that reduce the cost of CCUS.

Additionally, the UK Government is considering economic support for projects in different parts of the CCUS value chain, including CO<sub>2</sub> transit and storage, industrial and power projects with CCUS. The UK Government is employing a "build it and they will come" strategy for CO<sub>2</sub> transportation and storage, providing funding to the first movers ready to build CCUS infrastructure and guaranteeing a rate of return. When supply is likely to surpass demand during the initial phases, the USD 1.4 BB\$ CCUS Infrastructure Fund (CIF) will help in covering capital expenses. Then, under an Economic Regulatory Regime, transportation and storage providers will be granted licences to charge user fees to CO<sub>2</sub> emitters at a regulated rate of return.

Industrial CCUS will also be provided financial assistance similar to transportation and storage. Industrial facilities using CCUS can seek funding from the USD 435 MM\$ CIF or the Industrial Energy Transformation Initiative (IETF) to de-risk feasibility studies and early deployment projects. Mining, manufacturing, material recovery and recycling, and data centres are eligible for the IETF. An Industrial Carbon Capture contract between the project owner and a government-appointed counterparty will provide ongoing financial support. The counterparty will pay a strike price based on estimated operational costs that have been negotiated. Power plants with CCUS will not receive capital support for construction but can receive ongoing economic support and operational subsidies. Power plants with CCUS will enter into Dispatchable Power Agreements with a government-appointed counterparty, which will pay an availability payment for capacity and a variable payment so that electricity from CCUS based plants is less expensive than from unabated fossil fuel based plants.

The deployment strategy for CCUS in the United Kingdom focuses on creating CCUS clusters in industrial hubs around the country. The two CCUS clusters initially identified are the Teeside and Humber cluster on the North Sea. The Scottish cluster has been designated as a “reserve cluster” in the event that one of the two selections fails to reach an agreement with the UK Government during discussions. The clusters plan to capture carbon from fossil fuel power generation, biomass power production, hydrogen production, nitrogen production, steel production, and waste-to-energy initiatives. The selected clusters, as well as other clusters that have been evaluated, are primarily located near the North Sea, home to much of the UK’s oil and gas production. The UK Government is also supporting the domestic oil and gas industry in lowering carbon emissions by supporting joint investments of up to USD 4 BB\$ in CCUS projects.



### 5.2.5 Australia

Australia has been working proactively towards achieving its emissions reduction targets and aims to be a net-zero economy by 2050. The Australian Government has identified CCUS as a crucial element of

achieving net-zero and articulated the same in their Low Emission Technology Statement (LETS). The Australian Government is providing grant funding, regulation amendment and policy support for promoting the development of CCUS infrastructure. By 2030, the Australian Government plans to invest AUD 20 BB\$ in low emissions technology, including CCUS, and have made a series of investments in CCUS technology development in the form of grant support. In 2021, the Australian Government also launched an AUD 250 MM\$ programme called the “CCUS Hubs and Technologies Programme” to develop collaborative partnerships and make CCUS deployment affordable at a commercial scale. A part of the programme (“Technology stream”) will fund R&D for scaling up of CCUS technologies and identification of viable CO<sub>2</sub> storage sites; the second part (“Hubs stream”) will fund the design and development of CCUS transportation and hubs infrastructure that can be shared by co-located CO<sub>2</sub> emitters.

Another example of grant support by the Australian Government is the Carbon Capture, Use and Storage Development Fund of AUD 50 MM\$, which supports six projects for the development of carbon capture technology and demonstration in different industries, along with CO<sub>2</sub> storage or utilization.

The Australian Government has also implemented regulations to incentivize private sector investment in CCUS to ensure emission reductions. The “Offshore Petroleum and Greenhouse Gas Storage Act 2006 (OPGGSA)” was amended in May 2020 to allow CO<sub>2</sub> injection and storage across state and territorial jurisdictions. The Australian Government has also made emission reduction performance-based regulatory standards and obligations a requisite for the approval of storage projects. An example is the Gorgon CCUS project, where a necessary condition for project approval was the injection of at least 80% of the CO<sub>2</sub> emitted by the plant.

One of the key risks in CCUS projects is the long-term storage liability of CO<sub>2</sub>, which demotivates private investors. As a risk mitigation measure, the Australian Government has enacted legislation related to long term storage liability, which enables project developers/CO<sub>2</sub> storage site owners to obtain a declaration for the end of the “Closure Assurance Period” 15 years after a CCUS site closure, post which the project developer/CO<sub>2</sub> storage site owner shall no longer be liable for damages to the storage site and will have indemnity for any liability occurring after the Closure Assurance Period.

## 5.3 CCUS Policy Framework for India

Based on the review of the prevailing policy mechanisms in different parts of the world, it is clear that there are two clear policy choices/approaches for India to adopt, i.e.

- a) Carbon credits/incentives based policy
- b) Carbon tax based policy







A comparison of the two policy approaches is provided in Table 5-3.

**Table 5-3: Comparison of Carbon Credits/Incentives and Carbon Tax Based Policy**

Policy type	Carbon credits based policy	Carbon tax based policy
<b>Key aspects of the Policy</b>	<ul style="list-style-type: none"> <li>- Incentivizes CCUS adoption &amp; drives down the cost of capture</li> <li>- Establishes markets for carbon-based products</li> <li>- Offsets carbon capture costs through financial instruments and future taxes &amp; growth</li> <li>- Most suitable for decarbonization of existing industrial asset base</li> </ul>	<ul style="list-style-type: none"> <li>- May not directly incentivize CCUS</li> <li>- CCUS not established in India - acceptability and affordability of carbon tax is uncertain</li> <li>- Eventually required in the long term</li> <li>- Potential near term problems:               <ul style="list-style-type: none"> <li>• May lead to industrial migration and loss of competitiveness</li> <li>• Effectiveness questionable in the near term</li> </ul> </li> </ul>
<b>Trading scheme</b>	Tax credit equity trading	Carbon emissions trading
<b>Application examples</b>	<ul style="list-style-type: none"> <li>- US 45Q tax credits</li> <li>- Netherlands' SDE++ scheme</li> <li>- UK power sector Contracts-for-Difference (CfD)</li> <li>- UK CCUS Infrastructure fund</li> <li>- EU Innovation fund</li> </ul>	<ul style="list-style-type: none"> <li>- EU ETS</li> <li>- China ETS</li> <li>- Norway CO<sub>2</sub> tax</li> <li>- Canada Output-Based Pricing System (OBPS)</li> <li>- California cap-and-trade</li> </ul>
<b>CCUS project examples</b>	<ul style="list-style-type: none"> <li>- Petra Nova CCUS (USA)</li> <li>- Gorgon LNG (Australia)</li> </ul>	<ul style="list-style-type: none"> <li>- Sleipner (Norway)</li> <li>- Snøhvit (Norway)</li> </ul>
<b>Carbon subsidy/tax examples</b>	<ul style="list-style-type: none"> <li>- US 45Q tax credit:               <ul style="list-style-type: none"> <li>• up to 60 USD/t CO<sub>2</sub> for EOR &amp; conv.</li> <li>• up to 85 USD/t CO<sub>2</sub> for storage</li> <li>• up to 180 USD/t CO<sub>2</sub> for DAC</li> </ul> </li> <li>- Australia: AUD 60 MM\$ for Gorgon LNG project</li> <li>- Canada: CAD 865 MM\$ for Quest</li> </ul>	<ul style="list-style-type: none"> <li>- EU ETS: 34 Eur/t CO<sub>2</sub></li> <li>- Canada ETS:               <ul style="list-style-type: none"> <li>• 2021: 30 USD/t CO<sub>2</sub></li> <li>• 2030: 170 USD/t CO<sub>2</sub></li> </ul> </li> <li>- Norway:               <ul style="list-style-type: none"> <li>• 2021: 590 NOK (~70 USD) /t CO<sub>2</sub></li> <li>• 2030: 2000 NOK (~237 USD)/t CO<sub>2</sub></li> </ul> </li> </ul>
<b>Suitability</b>	Developing economy like India	Developed economies like EU

The key elements to be considered while formulating a CCUS policy framework for India are tabulated in Table 5-4.

**Table 5-4: Key Elements of a CCUS Policy Framework for India**

Element	Details
 <b>Policy path</b>	<ul style="list-style-type: none"> <li>- In the near term, CCUS policy should be carbon credits or incentives based, to seed and promote the CCUS sector in India through tax and cash credits</li> <li>- Over time (probably beyond 2050), the policy should transition to carbon taxes, so as to enable reaching India's net zero goals by 2070</li> <li>- The policy should establish early stage financing and funding mechanisms for CCUS projects</li> </ul>
 <b>Hub &amp; cluster business model</b>	<ul style="list-style-type: none"> <li>- Regional hub &amp; cluster models need to be established to drive economies of scale</li> <li>- The role of emitters, aggregators, hub operator, disposers and conversion agents needs to be defined</li> </ul>
 <b>Low carbon products</b>	<ul style="list-style-type: none"> <li>- Preferential procurement in Government tenders for low carbon or carbon abated products</li> <li>- Incentives to foster innovation for low carbon products through schemes like PLI</li> </ul>
 <b>Environmental and social justice</b>	<ul style="list-style-type: none"> <li>- Distribution of benefits of economic value added created to communities most affected by environmental and climate change</li> <li>- Protection of communities and jobs, especially in sectors affected by clean energy regulations</li> </ul>
 <b>Accounting and regulatory framework</b>	<ul style="list-style-type: none"> <li>- Regulated emission levels and allowances for different sector</li> <li>- Adoption of Life Cycle Analysis (LCA) framework to take into account Scope 2 and Scope 3 emissions and drive effective carbon abatement</li> </ul>
 <b>Risk mitigation</b>	<ul style="list-style-type: none"> <li>- Limiting the CO<sub>2</sub> liability and ownership of participants across the CCUS value chain</li> <li>- Monitoring, Verification and Accounting (MVA) framework and monitoring for risk management</li> </ul>

## 5.4 CCUS Clusters for CO<sub>2</sub> Capture and Disposition at Scale

The key to a successful CCUS policy for India is a framework that supports the creation of sustainable and viable markets for CCUS projects. The framework must consider the fact that the private sector is unlikely to invest in CCUS unless there are sufficient incentives to do so (or conversely penalties from inaction), or unless it can benefit from the sale of CO<sub>2</sub> or gain credits for emissions avoided under carbon pricing regimes. Direct capital grants, tax credits, carbon pricing schemes, operational subsidies, regulatory requirements, and public procurement preference for low-carbon products are some of the policy measures required for CCUS to become a reality in India. In this section we look at the concept of CCUS clusters required for CO<sub>2</sub> capture and disposition at scale, and how policy mechanisms can drive and support the same.

### 5.4.1 Basic Concept

The concept of clusters is well established in the economics of industrial development. An industry cluster is a geographic concentration of interconnected businesses, suppliers, and associated organizations in a specific geographical area. For CCUS, clusters will be advantageous for emissions-intensive facilities (both industrial facilities and power plants) co-located in geographical clusters and provide incentives to CO<sub>2</sub> emitters to form a capture cluster, which can be connected to a large-scale CO<sub>2</sub> storage site using an oversized shared transport infrastructure, as well as options for utilization of CO<sub>2</sub> to produce low carbon downstream products.

The oversized carbon disposition infrastructure would be too large for single users but rather be designed for multiple users/emitters.

The anchor project would be large CO<sub>2</sub> emitters, viz. a thermal power plant or a large industrial facility, which can cover the initial infrastructure costs, thereby enabling cost-effective CCUS deployment based on incremental capital and operating expenses. Emitting industrial clusters are frequently co-located with power generation facilities, thus providing substantial capturable CO<sub>2</sub> sources. The CO<sub>2</sub> disposition can be spread across multiple but reasonably closely located geological sequestration sites and/or oil fields for enhanced oil recovery (EOR).

Both emitters and storage sites need to interconnect through hubs, similar to the natural gas distribution industry, where pipeline networks are interconnected in order to collect gas from many different production fields, and to distribute the gas in the market. One hub would service the collection of CO<sub>2</sub> from a capture cluster or distribution of CO<sub>2</sub> to a storage cluster, as depicted in Figure 5-1. Hubs can be built at the capture,

collection, or storage end of a multi-user pipeline or both (forming capture/collection or storage hubs). Depending on the individual emissions sources within the cluster, the volume and composition of the captured CO<sub>2</sub> can vary significantly. Collection and storage hubs will offer compressed CO<sub>2</sub> transportation services, thus substantially lowering the cost of transportation infrastructure between point source emitters and CO<sub>2</sub> injection points.

The elements along the CCUS value chain (CO<sub>2</sub> source, capture, transport, injection, and storage) are brought together in a CCUS hub and cluster network, with multiple co-located (clustered) source capture facilities (of the same or different types) supplying CO<sub>2</sub> to a shared “oversized” transport and storage system. With the growth of the CO<sub>2</sub> supplier or emitter base, the transport and storage infrastructure must expand through multiple transport pipelines, injection facilities, and storage formations (depending upon local geological characteristics). Multiple and high concentration sources of CO<sub>2</sub> in a close geographical location with neighbouring storage capacity will make the CCUS infrastructure effective & economical.

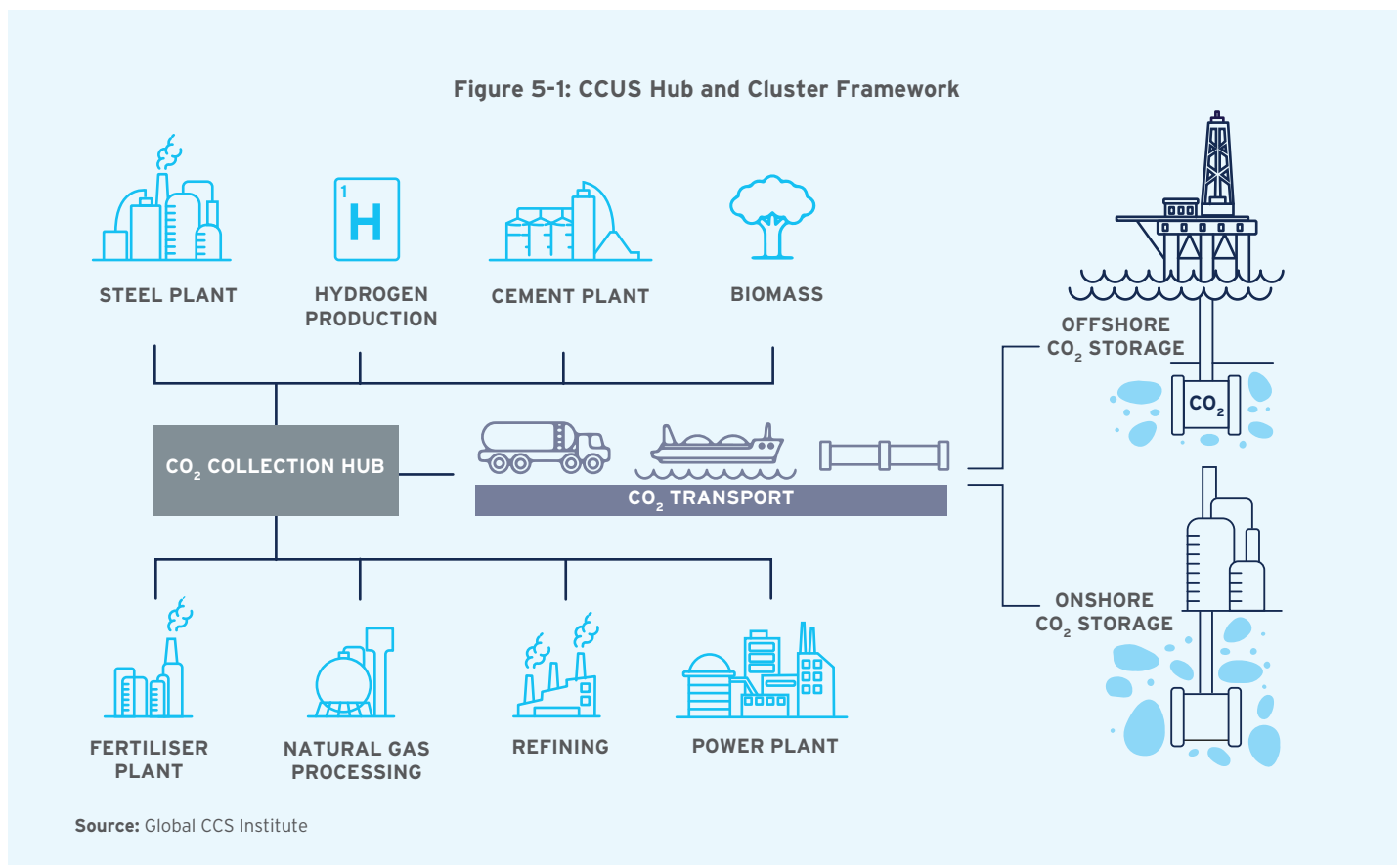



### 5.4.2 Economic and Business Rationale for CCUS Hubs and Clusters

The development and deployment of CCUS at scale requires the development of not only the technologies for CO<sub>2</sub> capture and use, but also the implementation of enabling transportation infrastructure and markets at Giga-tonne (GT) scale, along with the development of a complete value chain of capture, aggregation, transportation, disposition and use or storage. An effective CCUS hub and cluster framework will incentivize participants across the CCUS value chain by providing seamless access to CCUS infrastructure, minimize costs and coordination issues, offer opportunities to maximize benefits/profits and de-risk investments by widening the market, and abrogate the necessity of bilateral agreements between CO<sub>2</sub> sources and sinks.

For CCUS hubs and clusters to be effective, they need to:

- Provide sufficient incentives for both sources (CO<sub>2</sub> emitters) and sinks of CO<sub>2</sub> (CO<sub>2</sub> end-users) to participate in the market, as well as CO<sub>2</sub> aggregators and CO<sub>2</sub> marketers. This is especially relevant when entry involves large fixed costs that could limit participation
- Aggregate carbon emissions across emitters to create economies of scale
- Exploit different storage and use patterns across geographical regions or clusters
- Enable market clearing of CO<sub>2</sub> demand and supply within and across regions through interconnecting hubs
- Recognize the heterogeneity of emitters, and provide them open access to the hub and cluster network for CO<sub>2</sub> disposition

#### CO<sub>2</sub> Pricing and the Necessity of Markets

Capture costs are dependent on a number of factors, including the source, density and purity of the CO<sub>2</sub> emission stream. Transportation costs depend on volume and distance, and injection costs depend on volume and site location. If a utilization opportunity exists, the costs depend on the application, with enhanced oil recovery (EOR) being an injection activity while applications like chemicals or advanced materials being dependent on a host of other factors. The build up of these costs across the CCUS value chain can become the substantial and prevent the development and implementation of CCUS projects.

Hence there is a necessity for a market model for encouraging and incentivizing scale & innovation, leading to lower costs and prices for participants across the CCUS value chain.

Innovations in the CCUS context could involve technologies and applications leading to creation of value added products from CO<sub>2</sub>, such CO<sub>2</sub> to chemicals, cement and advanced carbon materials. As with any innovation, it is difficult to predict which of these applications will reach commercialization earlier than the others. Innovation could reduce costs across the CCUS value chain or also bring forth new pathways for using CO<sub>2</sub> as a feedstock, leading to higher demand and prices for carbon and CCUS.

Prices will be governed by both expectations of future demand-supply as well as the level of competition in the market on both the demand and supply side. Sufficient competition is necessary for efficient pricing, leading to efficient allocation of resources for CCUS and sharing of gains between the supply and the demand side. On the supply side, the market needs to incentivize participation by sellers that can supply CO<sub>2</sub> at the lowest cost. On the demand side, the CO<sub>2</sub> should be allocated to buyers that have the highest value usage and ability to pay the CO<sub>2</sub> price.

Auctions provide a way for the efficient allocation of resources. Consumers of CO<sub>2</sub> can compete against each other so that the final bids reflect the highest-value use for CO<sub>2</sub>. A higher price for CO<sub>2</sub> implies that demand is higher than supply and should incentivize new CO<sub>2</sub> emitters (supply) to capture CO<sub>2</sub> and enter the CCUS value chain/market. However, during the initial operations of the CCUS value chain with a small market and limited number of participants, CO<sub>2</sub> emitters may need additional incentives to enter the market, through measures such as administered pricing mechanisms. It is likely that more efficient and purely demand-supply based pricing mechanisms will emerge as markets mature and grow in size.

Hubs and clusters provide a valuable market-making mechanism for de-risking investments and incentivizing participation in the CCUS value chain. During their initial period, Government support (either in the form of federal & private investments, tax credits, carbon taxes) is critical for ensuring sufficient participation and success, till the market reaches scale and efficiency. The next section discusses some of the CCUS hubs and clusters in different parts of the world.

### 5.4.3 Review of CO<sub>2</sub> Clusters Around the World

The major CCUS cluster around the world are illustrated below. Many of the clusters are located near ports with large industrial footprints, and provide regions and countries a competitive advantage in a carbon-constrained world.

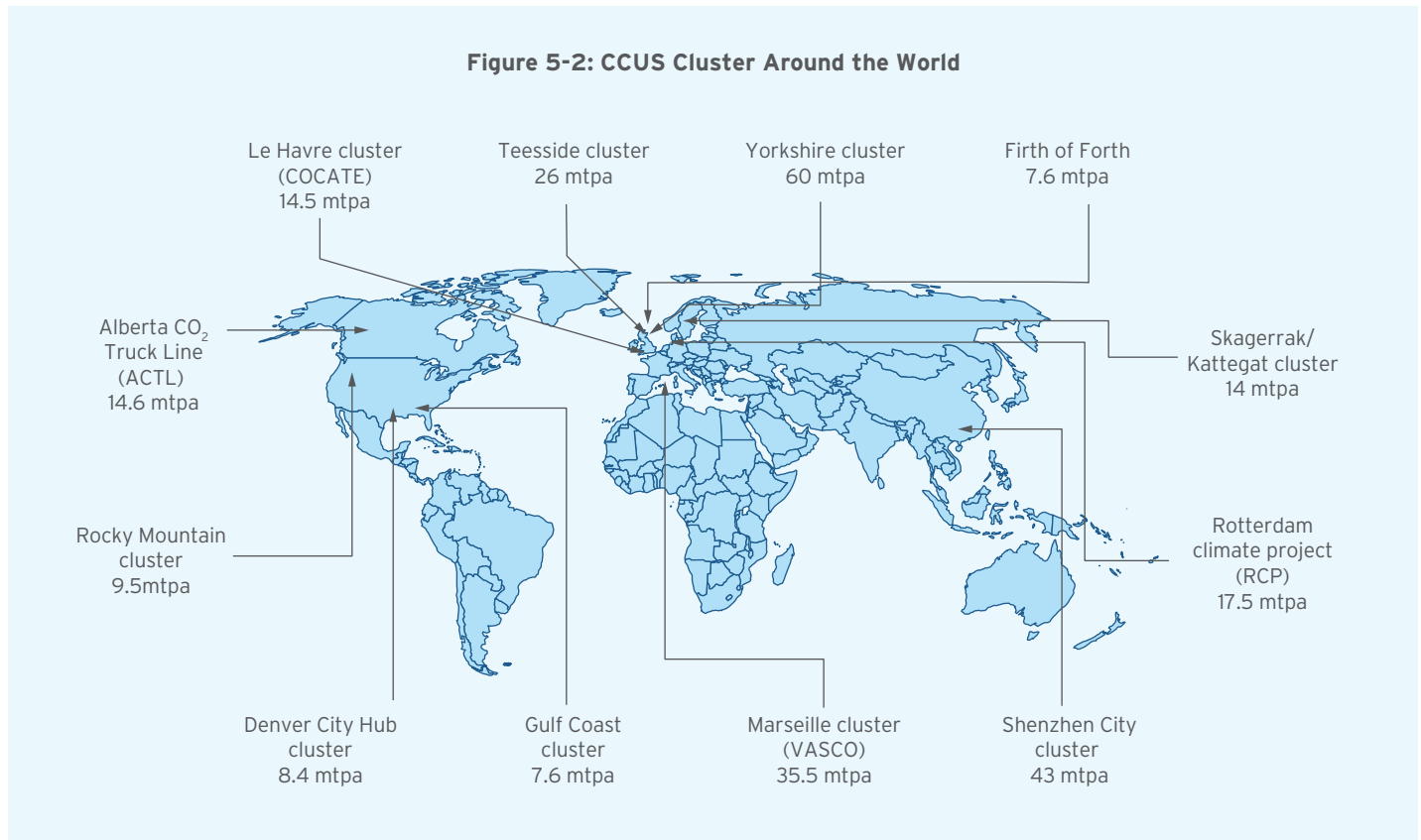

#### 5.4.3.1 Rotterdam Cluster Project (RCP), Netherlands

**i) Outline:** This cluster is supported principally through the Rotterdam Climate Initiative, which is a partnership between the City of Rotterdam, the Port of Rotterdam, DCMR Environmental Protection Agency Rijnmond, and Deltalinqs, an association of industrial enterprises in the Rotterdam area. The initiative started with the objective of reducing CO<sub>2</sub> emissions by 50% within 2030. The vision includes a full CO<sub>2</sub> network capturing CO<sub>2</sub> from the power plants and industries in the Rotterdam area and transporting the CO<sub>2</sub> for offshore storage. The long term vision is to extend beyond the Rotterdam region and also to neighbouring countries and beyond the Dutch continental shelf. The plan is to develop the project as an integrated CCUS cluster project, termed as

ROAD (Rotterdam Opslag en Afvang Demonstratie, or Rotterdam Storage and Capture Demonstration)

**ii) Capture:** The ROAD project initially had a capacity of 1.1 mtpa with a single carbon capture unit for capturing 25% of the flue gas from a coal-fired power plant. A collection of projects have entered into cooperation agreements, which may increase the capture volume by an additional 5 mtpa. The Rotterdam area has outsized CCUS infrastructure, which can capture and sequester up to 17.5 mtpa of CO<sub>2</sub> by 2025 and become a regional centre by storing CO<sub>2</sub> from other parts of the Netherlands, and potentially the neighbouring countries of Germany and Belgium.

Long term economic analysis reveals the potential to capture up to 62 mtpa of CO<sub>2</sub> considering the available onshore and offshore reservoirs.

- iii) **Transport:** CO<sub>2</sub> will be transported by a dedicated pipeline to a depleted gas field located 25 km offshore. The pipeline will be insulated to ensure the CO<sub>2</sub> is warm enough to be injected into the low pressure depleted reservoir. In subsequent phases of the project, other sources would be connected to the offshore section of the line, which will be modified to transport up to 5 mtpa. This phase will also include a network extension to connect more CO<sub>2</sub> sources and sinks, along with assessments of connectivity to other prospective CO<sub>2</sub> hub locations which can share the transportation infrastructure.
- iv) **Storage:** Initially, the CO<sub>2</sub> is planned to be stored in the offshore P18 field's reservoirs 6, 5 and 2, which have a capacity of up to 42.4 mtpa. Initial investigations also reveal the possibility of storing up to 259 mtpa of CO<sub>2</sub> in other fields in the area.
- v) **Funding:** The Dutch Government will be granting the project consortium (which includes Royal Dutch Shell and ExxonMobil) around USD 2.4 BB\$ in subsidies for what is set to become one of the largest CCUS projects in the world.
- vi) **Value proposition:** The main value proposition is the competitive cost structure of the Rotterdam hub vis-à-vis CCUS projects worldwide, providing a one-stop CO<sub>2</sub> disposition solution for CO<sub>2</sub> emitters and making carbon abatement a part of the Rotterdam city's and port's goals. The competitive cost structure is driven by the favourable location, with sources and offshore sinks co-located, making CO<sub>2</sub> transport simpler and less expensive. Other reasons are the economies of scale and the potential of CO<sub>2</sub> being shipped to the cluster from other CO<sub>2</sub> emitting areas, thus leading to high capacity utilization.
- vii) **Revenue streams:** The main revenue stream will be from the CO<sub>2</sub> transit charge collected from emitters. There is also an option of the Government providing loans or investments for early project development, with analysis indicating that the revenues to the Government from royalties and taxes earned through CO<sub>2</sub> EOR will compensate underwriting the initial project costs and risks.

**Figure 5-3: Rotterdam CCS Cluster**

**Rotterdam CCS cluster** - Locations of licensing blocks with depleted fields identified as suitable for CO<sub>2</sub> storage



#### 5.4.3.2 Teesside UK Cluster, UK

- i) **Outline:** A significant number of large CO<sub>2</sub> emitting industries are located around the mouth of the River Tees on England's NE coast. Net Zero Teesside is a carbon capture, utilization, and storage (CCUS) initiative in the Teesside region of England that aims to reduce industrial emissions. It entails the construction of an 840 MW gas-fired power station fitted with carbon capture technology, as well as the creation of CO<sub>2</sub> collection network to enable low-carbon hydrogen production. Initially, the project aims to capture up to 10 mtpa of CO<sub>2</sub> emissions. Along with the Teesside cluster, another CCUS cluster is also coming up around the river Humber on the East Coast of England. The CO<sub>2</sub> from both projects will be permanently stored in a geological aquifer in the Southern North Sea.
- ii) **Capture:** The project includes a single-source initial anchor project, as well as other small, medium, and large CO<sub>2</sub> emitters.

The anchor emitter will inject 5 mtpa of CO<sub>2</sub> in the hub, and the capacity will increase with other emitters joining the hub. These emitters would be across industries such as power plants, steel plants, chemical plants, petroleum refineries, biomass based plants and other sources. Additionally, a new IGCC plant using underground coal gasification is also being explored.

- iii) **Transport:** The hub has been designed with a notional 200 km offshore line that can reach several potential storage sites, along with the possibility of shipping during the capacity build-up phase.
- iv) **Storage:** Studies have identified a handful of prospective offshore storage sites within a 200-kilometer radius. Further studies on the characterization of the reservoirs is being undertaken. The high-level storage costs are predicted to be between £12 - 14 per tonne of CO<sub>2</sub>.
- v) **Funding:** The project has secured about USD 39 MM\$ 28m of public funding from the UK Research and Innovation (UKRI) Industrial Decarbonisation Challenge fund.
- vi) **Value proposition:** The core value proposition for participating industries is avoiding payments on emission certifications, as pooling transportation and storage facilities will make CCUS less expensive. Teesside's proximity to storage locations makes it a low-cost option for CCUS in the UK.
- vii) **Revenue streams:** The main revenue stream would be transport and storage payments from emitters, either in the form of tariffs or based on equity/cost recovery arrangements. Government support would be needed to cover the business risks in the form of CO<sub>2</sub> floor prices, CCUS fees, and demonstration project funding.
- viii) **Business model:** To further support the development of the CCUS hubs and clusters, the UK Government, in consultation with the industry, is also developing a business model for Industrial Carbon Capture (ICC) projects. The key elements addressed by the business model are:
  - Commercial framework for ICC projects, including the payment mechanism between different counterparties in the CCUS value chain

- Transport and Storage (T&S) fees
- Carbon price
- Conditions and time period for which capital grant and ongoing revenue support will be provided by to eligible projects by the Government
- Risk allocation and mitigation
- Carbon intensity of industrial products and free allowances
- Legal contractual framework and draft contract for Industrial Carbon Capture between CO<sub>2</sub> emitters and counterparties
- Conditions precedent and milestones
- Metering and reporting requirements

#### 5.4.3.3 Denver City Hub Cluster, USA

- i) **Outline:** The Denver City hub is located in Texas and is part of the trunk line for transporting CO<sub>2</sub> from naturally occurring underground resources to EOR projects. Several long-distance CO<sub>2</sub> pipelines converge at Denver City in Texas, from where CO<sub>2</sub> is distributed to over 40 oilfields for EOR. Kinder Morgan is the primary partner in the Denver City hub and operates a variety of oil & gas production and distribution facilities in addition to the CO<sub>2</sub> business. Other large oil and gas firms, such as Occidental, BP, Amerada Hess, and Exxon Mobil, are co-owners and operators of parts of the system. There are efforts to expand the hub to other locations for CO<sub>2</sub> EOR as well as large sources of anthropogenic CO<sub>2</sub> emissions.
- ii) **Capture:** Presently the CO<sub>2</sub> entering the system comes from natural CO<sub>2</sub> reservoirs. The plan is to inject CO<sub>2</sub> emissions from natural gas processing plants in the region, given the total system capacity of 45 mtpa, considering the four main pipelines and the available natural CO<sub>2</sub> reservoirs in the hub.
- iii) **Transport:** Transportation is by supercritical-pressure pipeline, and additions are common in both design and operation. A 160-kilometer pipeline has been built from the facility to the Denver City hub for the Century natural gas processing project of Occidental Petroleum in West Texas, which is the largest carbon capture plant in the world, with a capacity of 8.4 mtpa of CO<sub>2</sub> capture.

- iv) **Storage:** The CO<sub>2</sub> is entirely utilized for EOR projects and there are no projects purely for storage.
- v) **Value proposition:** The current CO<sub>2</sub> value proposition is based on the profitability of extracting additional oil using CO<sub>2</sub> EOR. The costs per tonne of CO<sub>2</sub> delivered hence should be substantially lower than the value of the extra oil recovery. Recent contracts have also incorporated specific carbon credit provisions, based on the minimum offtake of CO<sub>2</sub>.
- vi) **Revenue streams:** Transportation tariffs and CO<sub>2</sub> sales are the two main revenue streams, apart from the potential revenues from the credits earned through the project.

Figure 5-4: Timeline Denver City Hub

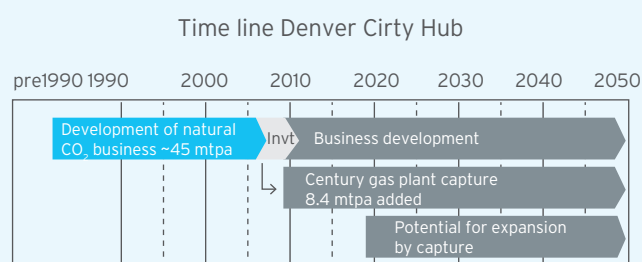
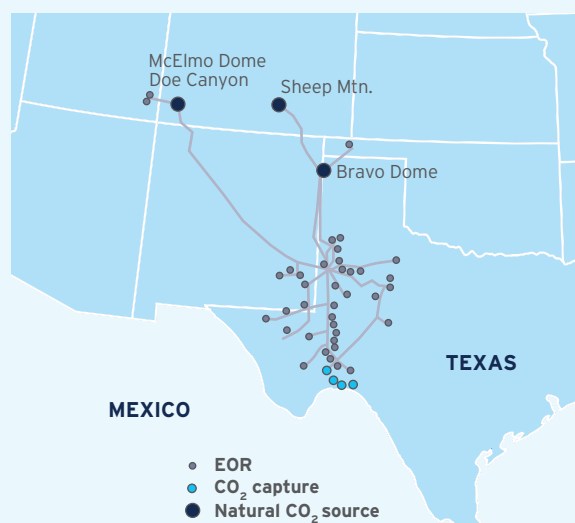

Figure 5-5: Denver City Storage



#### 5.4.3.4 The Alberta Carbon Dioxide Trunk Line (ACTL)

- i) **Outline:** The project is based on the synergy between oil producers who can benefit from CO<sub>2</sub>-EOR and CO<sub>2</sub> emitters, particularly from the oil & gas industry, who can abate their CO<sub>2</sub> emissions. The project consists of a central CO<sub>2</sub> trunk pipeline, similar to trunk lines in the oil & gas industry.

The first phase consists of two capture locations. The CO<sub>2</sub> pipeline will be constructed and operated by Enhance Energy, for transporting the CO<sub>2</sub> for EOR. The EOR operations will also include monitoring of the stored CO<sub>2</sub> plume, design of wells and the injection programme and reservoir management.

- ii) **Capture:** The project started with two CO<sub>2</sub> sources: an Agrium fertilizer facility and the Sturgeon heavy oil upgrading refinery. The capture costs are CAD 21/tonne at Agrium (for 1.2 mtpa of CO<sub>2</sub>) and CAD 12/tonne at Sturgeon (for 0.4 mtpa). The trunk line capacity is expected to be expanded to 14.6 mtpa, which allows headroom for adding further emitters.

- iii) **Transport:** The CO<sub>2</sub> is transported over a 242 km pipeline (12 km having 12" dia and 220 km having 16" dia). The pipeline stretches from the Edmonton industrial area to the Clive oil field, south of the city. A spare 12" line will be constructed where the 12" portion crosses the Saskatchewan river. The line has a maximum allowable working pressure (MAWP) of 179 bar and is sunk to a minimum depth of 1.2m. The CO<sub>2</sub> is delivered at a pressure of 137 bar. There is no intermediate pumping in the initial phase; pumping stations would be required when the pipeline reaches the maximum capacity of 14.6 mtpa. The main line will be made of 14.3mm thick welded carbon steel, and does not require crack arrestors due to its thickness.

- iv) **Storage:** The Clive oil field will be the first storage site, with CO<sub>2</sub> injected into the Nisku and Leduc horizons for improved oil recovery. Based on re-pressurizing to the initial discovery pressure of 165 bar from the current depletion pressure of roughly 125 bar, the estimated CO<sub>2</sub> capacity is 18.9 mt (1800psig). However, the regional storage potential is significantly larger, estimated at 2000 mt.



v) **Value propositions:** The major value proposition is the delivery of CO<sub>2</sub> to CO<sub>2</sub>-EOR projects at a reasonable cost. Another advantage is the opportunity to minimize the “tax” on CO<sub>2</sub> emissions imposed by the Alberta Government and access to Government and private funding for carbon abated projects.

vi) **Revenue streams:** The project is being funded through Government support for investments and private venture capital. The main revenue sources are the payments received for the CO<sub>2</sub> delivered for EOR.

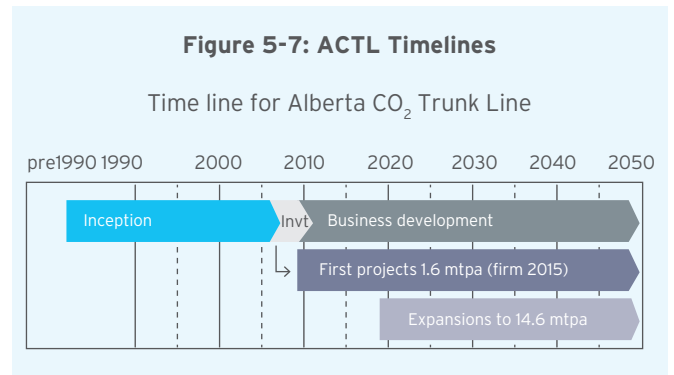

### 5.4.4 Critical Assessment of CO<sub>2</sub> Clusters

Based on the review of global CCUS clusters, clusters based on the utilization of CO<sub>2</sub> for EOR applications are the most successful. For projects involving the sequestration or the storage of CO<sub>2</sub>, the funding/cost gap for large scale CCUS deployment (whether as hub and spoke clusters or point-to-point projects), needs Government support and policies to incentivize carbon capture and sequestration. Economies of scale exist in merging CCUS infrastructure and result in lowering pipeline and transportation costs. However, Government support is required for funding the capital costs, de-risking CCUS projects and building confidence amongst emission sources in the cluster to move forward with their plans.

The other major benefits offered by clusters could result from combining organizational costs, acquiring permissions, winning public acceptability, and pooling professional services such as O&M of carbon capture facilities, chemical supply & waste disposal, and CO<sub>2</sub> measurement & accounting services.

Because of the high mobilization and laying expenses, cost reductions for CCUS cluster projects are greater for offshore and distant storage locations. The economics of such CCUS cluster projects in the initial years are quite challenging due to lower CO<sub>2</sub> volumes and the outsized infrastructure created. This can be overcome if long-term and low-cost financing are available for clusters with competitive locations, both through Government support and access to international clean funds.

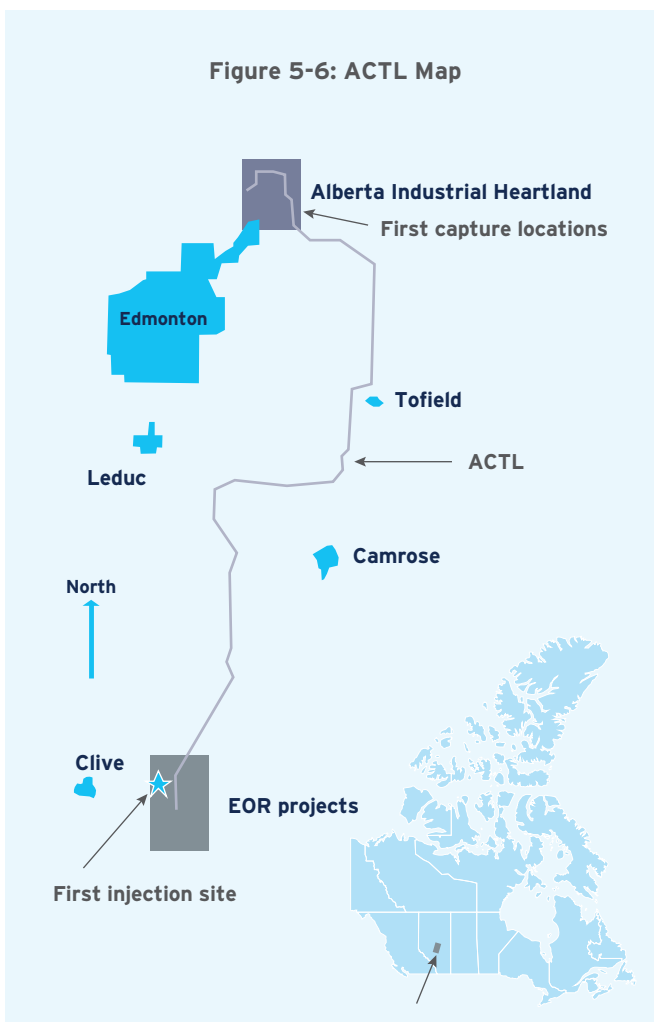



## 5.5 Hub and Cluster Framework for India

The merits of a hub and cluster framework make it the best suited for implementing CCUS in India. The first step is to map identified industry-wise clusters and suitable storage clusters in India. A cluster framework is both advantageous and necessary for incentivizing CO<sub>2</sub> capture from both large and small emitters. The underlying principles for a potential CCUS cluster framework in India are provided below:

### 5.5.1 Principles of Proposed Framework

#### 5.5.1.1 Evolutionary and Phase Cluster Model

An evolutionary and phased cluster model would be appropriate for India, as there are no commercial-scale CCUS projects in operation. CCUS can be deployed in a phased manner, prioritizing regions and industrial clusters based on their total CO<sub>2</sub> emissions. The cluster framework should also be adaptable and accommodate new local networks as and when they develop. This type of approach to CCUS deployment will enable India to build a scalable network, whereas a single point-to-point approach may not be scalable in the future and face issues of alternative storage spaces or lack of buyers for CO<sub>2</sub> in the future. A cluster model will ensure a robust market for the captured CO<sub>2</sub> by efficiently integrating the supply and demand sides.

#### 5.5.1.2 Hub Based Cluster Clearing Model

The cluster networks that will obtain CO<sub>2</sub> from emitters will supply CO<sub>2</sub> to the parties responsible for its utilization or sequestration. In case there is excess CO<sub>2</sub> (greater than the demand for utilization or storage) present with the cluster network, the excess CO<sub>2</sub> can be transferred to other networks that may have higher CO<sub>2</sub> demand. This transfer can be executed by centralized bodies or hubs. Hubs need to be created for the smooth operation of the CO<sub>2</sub> transfer process between the existing and upcoming cluster networks. These hubs will act as an exchange point for the cluster networks and enable the physical switching of CO<sub>2</sub>. Hubs will also ensure the de-risking

of CO<sub>2</sub> transport network assets, thereby making the entry to hub and cluster systems more profitable.

#### 5.5.1.3 Hub Investment as a Signal of Cluster Growth and Evolution.

Each hub can be the representative of certain clusters associated with it. Investment in the hub infrastructure will lead to the growth of various cluster networks connecting to it. This will lead to the evolution of cluster networks to cater to the CO<sub>2</sub> demand of multiple parties, who may be involved in either utilization, EOR or sequestration of CO<sub>2</sub>. Each cluster network will be a profit-maximizing cluster network. The profitability of these cluster networks will ensure the inflow of investment into the hubs & clusters, which would help them grow their operations. These clusters may be operated by a Government appointed body as a regulated monopoly and the pricing of CO<sub>2</sub> can be regulated throughout the value chain.

#### 5.5.1.4 Accounting for Innovation on the Supply and Demand Side

The possibilities of innovation on both the supply side (capture and transportation) and demand side (new pathways for CO<sub>2</sub> utilization) will be embedded in the design of the cluster framework. The innovations in the supply side can reduce the social cost of carbon capture. Innovations on the demand side will have a more prominent effect as it may generate new CO<sub>2</sub> based products. These additional competing uses of CO<sub>2</sub> with efficient pricing will result in resources being directed to the highest social value uses at any given time.

### 5.5.2 Architecture of Evolutionary Cluster Model

The grid design for the hub and cluster model is illustrated in Figure 5-8. This includes the various participants in an evolutionary cluster framework, such as emitters, local network (cluster), sequestration party, utilization party (EOR, conversion to chemicals, etc.).

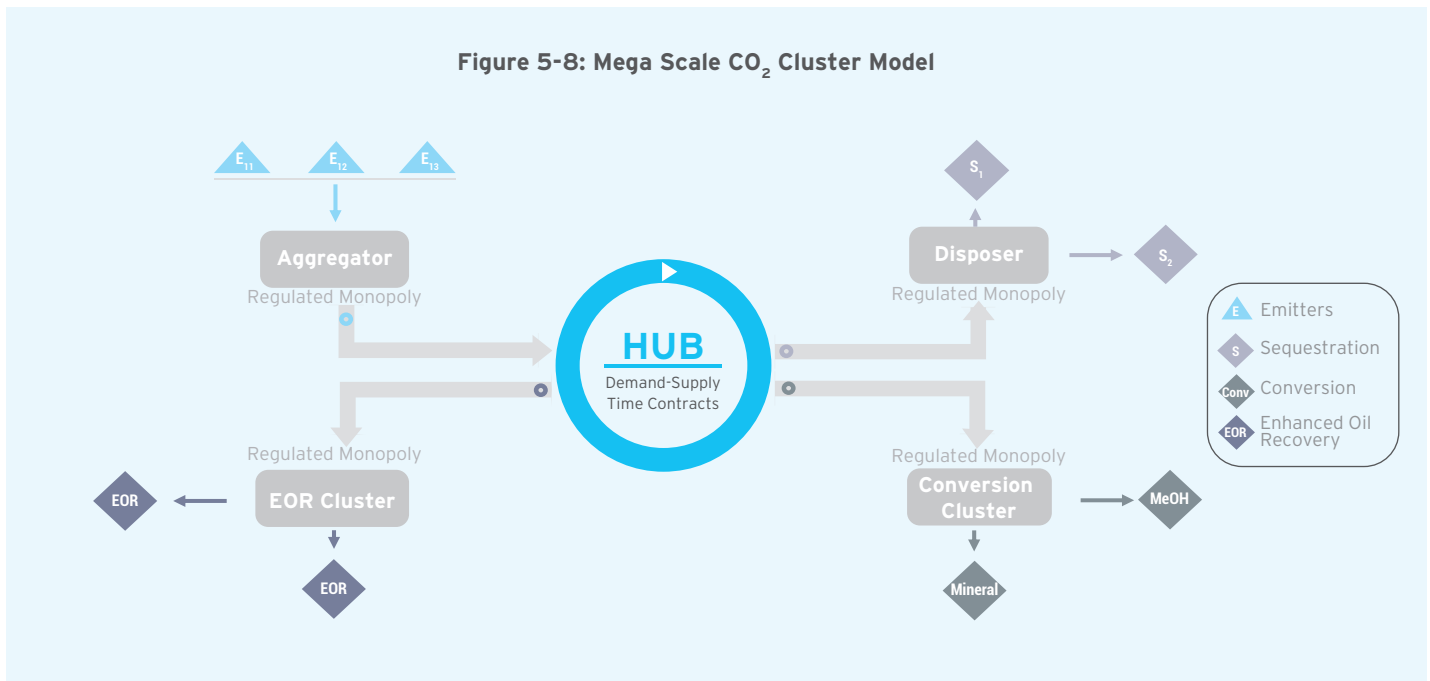
Figure 5-8: Mega Scale CO<sub>2</sub> Cluster Model

The emitters ( $E_{11}$ ,  $E_{12}$ ,  $E_{13}$ ) form the CO<sub>2</sub> emission cluster, with similar types of industries placed in an emission cluster and being connected to their local cluster network, which is operated by a CO<sub>2</sub> aggregator as a regulated monopoly. The storage operators ( $S_1$ ,  $S_2$ ) represent the storage cluster, where CO<sub>2</sub> will be sequestered without recovering any economically beneficial product. Similarly, there are clusters for EOR and CO<sub>2</sub> utilization.

The emitters have CO<sub>2</sub> capture technology suited to their quality of gas streams. The cluster will be initiated by an emitter with very large CO<sub>2</sub> emissions. This emitter is termed an anchor project. High purity CO<sub>2</sub> captured from emitters is transported to the local cluster network. These emitters will have to pay a fixed cost for using the local network's infrastructure. The transport infrastructure for the cluster is maintained by the local network bodies, thereby reducing the risk for individual industries. This increases the incentive for industries to join this kind of cluster network.

The captured CO<sub>2</sub> is then sent to the hub and from the hub to either sequestration sites  $S_1$  or  $S_2$ , to be stored in geological formations of deep saline aquifers or mineralized in the basalt formations. In return, the hub pays  $S_1/S_2$  a regulated charge based on the CO<sub>2</sub> volumes being stored. A similar process is followed for disposition of the CO<sub>2</sub> either through EOR or for

utilization of the CO<sub>2</sub> for producing methanol, mineral aggregates or other value-added products. The emitters are agnostic to the final CO<sub>2</sub> disposition; the disposition pathway is dynamically determined by the hub operator based on the demand-supply scenario.

In the future, a new cluster with a local network may want to join this hub, which would be possible due to the evolutionary model of hub and cluster systems. This will also bring in additional investments into the hub, leading to its growth. This new cluster may or may not have an emission source. In case it does not have an emission source, it will procure CO<sub>2</sub> from the hub. A new emission source may also come up in the future, which can be integrated with the new cluster network.

### 5.5.3 Region-wise Cluster Potential for India

The cluster potential has been analyzed for the five regions of India: North, South, East, West, and North-East. By identifying the nearest state/UT to the storage locations mentioned, the storage sites can be classified and mapped to the various regions. A similar practice has been carried out with the emission sources. The estimation of region-wise emission for the year 2030 is considered for analyzing the CO<sub>2</sub> volume emitted for the duration 2030 - 2050. Figure 5-9 illustrates the region-wise cluster potential data for India.

**Figure 5-9: Region-wise Storage Clusters in India**

**Total Theoretical Storage Capacity of India = 395 - 614 Gt CO<sub>2</sub>**

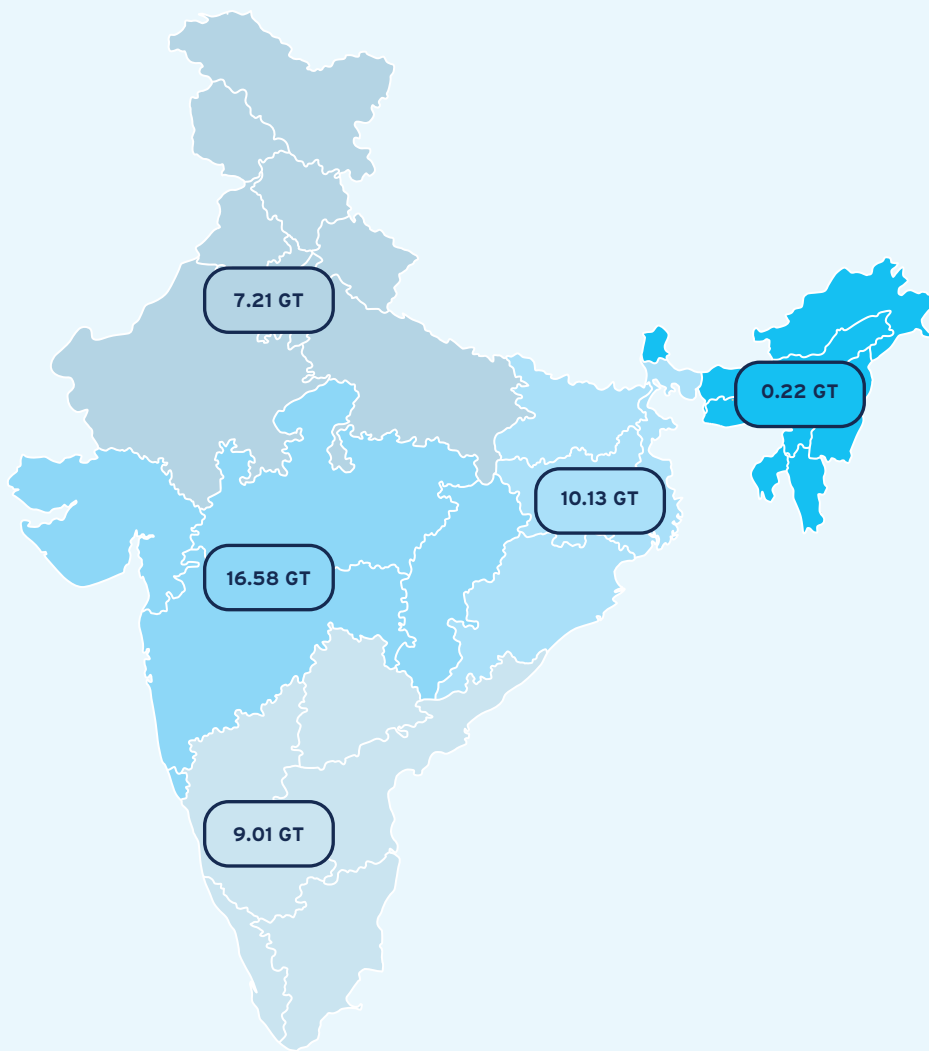

 Region-wise estimated CO<sub>2</sub> emission volume (2030-2050)

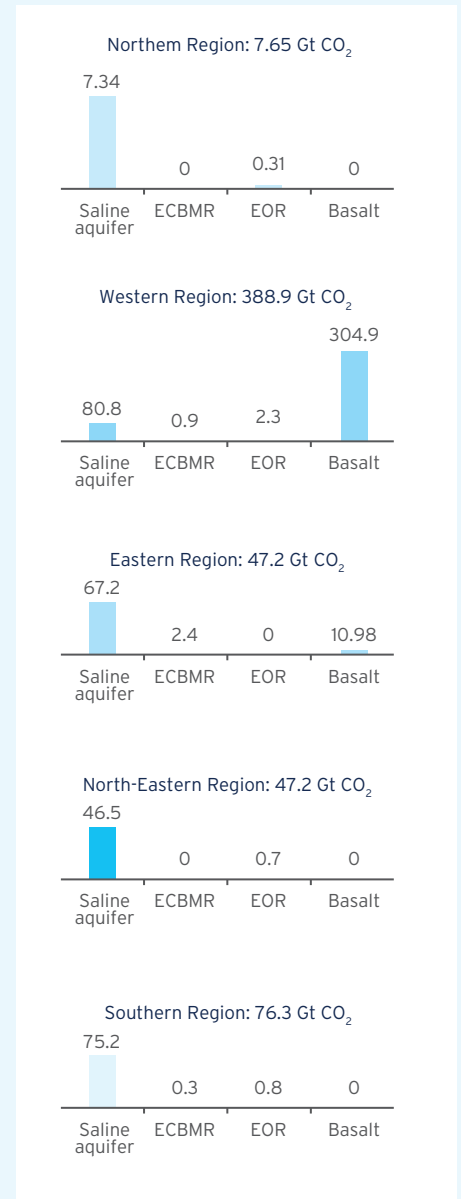

The region-wise storage cluster formation shows that sequestration in deep saline aquifers has the best potential in all the regions. Due to the lack of data on the northern sedimentary basins, the theoretical storage capacity for saline aquifers is low. But as more

exploratory activities are carried focused on CO<sub>2</sub> storage, the storage potential in the northern region is likely to increase. Few sedimentary basins span across multiple states and they have been mentioned in Table 5-5.

**Table 5-5: Sedimentary Basins Spanning Across Multiple Regions**

Basin name	Basin category	State/UT	Theoretical storage potential (Gt of CO <sub>2</sub> )
Vindhyan	Category II	Madhya Pradesh/ Uttar Pradesh/ Rajasthan	11.81
Satpura- South Rewa- Damodar	Category III	Madhya Pradesh/ Chhattisgarh/Jharkhand	1.87
Bhima-Kaladagi	Category III	Maharashtra/ Karnataka	0.41
<b>Total</b>			<b>14.09</b>

**ECBMR:** The potential for ECBMR is localized in the eastern region due to the presence of major coalfields. These can be storage clusters for industries that are close to the coalfields, such as steel and power plants.

**EOR:** The potential for EOR will increase in the future as more wells are maturing and newer wells may be discovered through exploratory activities.

**Storage in basalt formations:** Mineralization in basalt formations provides a large opportunity for CO<sub>2</sub> storage in the western region, but is currently in a nascent stage of development.

Comparing the region-wise emission volumes during the time horizon of 2030 - 2050 and the theoretical storage capacity, sufficient storage capacity is available for cluster formation in each region. The formation of hubs will result in a smooth transfer of CO<sub>2</sub> between clusters of different regions. Apart from the four CO<sub>2</sub> disposition options discussed above, several other CO<sub>2</sub> utilization clusters (CO<sub>2</sub> to chemicals, new utilization techniques, etc.) can evolve and become more viable over time, thus increasing the options for abatement of enhanced volumes of CO<sub>2</sub> from the power and industrial sector.

## 5.6 Key Risks Associated with CCUS

The CCUS policy framework for India should also address the key risks associated with the CCUS value chain. CCUS projects integrate various sub-systems such as carbon capture, transportation, and sequestration. The interfaces between the sub-systems projects involve complex interfaces and lead to risks associated with CCUS projects. Some of the key risks and their mitigation measures are described below:

### 5.6.1 Technical Risks

#### 5.6.1.1 Reservoir Suitability for CO<sub>2</sub> Flooding for EOR

The extent of CO<sub>2</sub> abatement possible through EOR depends on the comparative performance and cost-effectiveness of CO<sub>2</sub> EOR vis-à-vis other methods of tertiary recovery like nitrogen injection, polymer injection, steam injection, natural gas injection, and the use of foaming agents. Some of the current developments, such as the use of foams or other chemicals to improve sweep efficiency may reduce the attractiveness of CO<sub>2</sub> EOR, while on the other hand,

exploration and production from more complex hydrocarbon resources may increase the role of CO<sub>2</sub>. Hence it is necessary to monitor the developments of other tertiary recovery systems, as well as use improved reservoir simulation tools to understand CO<sub>2</sub> flooding and EOR performance. It is also important to calibrate financial commitments to capacity expansions based on assured future offtakes for CO<sub>2</sub> to mitigate this risk.

#### 5.6.1.2 Change in Processes Emitting Industries:

This risk emanates from the possibility of using electricity or new clean energy carriers to replace the use of fossil fuels in industrial processes like iron & steel or cement, thereby substantially impacting the CO<sub>2</sub> emissions available for capture. Even the power sector is not immune to such changes: for example, base-load plants may transition to only peaking operations, limiting the quantity of CO<sub>2</sub> emissions. Therefore it is important to develop a understanding of the industrial processes and the likely trajectory of technological innovation in the industry, as well as the risk of the end-products of the industry getting replaced by alternate products.

#### 5.6.1.3 Offshore Unloading & Condition of Shipped CO<sub>2</sub>

CO<sub>2</sub> shipping is considered a future alternative to CO<sub>2</sub> piping and would involve vessels similar to semi-refrigerated LNG/LPG carriers that use pressurized tanks. Compared to a fixed pipeline based distribution network, CO<sub>2</sub> shipping provides flexibility to adjust to demand-supply dynamics and deploy ships/barges to different consumption points and allows for more gradual expansion of the CCUS system. One key issue is converting liquid CO<sub>2</sub> from temperatures as low as -50°C to a temperature suitable for injection. Significant heat energy would be required, involving cost and emissions, if done with fossil fuels. The logistics of ship unloading also need to be addressed, including issues related to ship loading & unloading rates to limit demurrage as well as using floating barges for offshore offloading.

#### 5.6.1.4 CO<sub>2</sub> Specification Challenges

Most carbon capture solutions try to address and meet the required CO<sub>2</sub> specifications. The key requirement is adequate dehydration, along with other impurity tolerances depending on the CO<sub>2</sub> source and capture process. However, problems may arise when integrating multiple CO<sub>2</sub> sources and capture processes, and additional treatment of the captured raw CO<sub>2</sub> may be required, depending on the

disposition pathway for the CO<sub>2</sub>. These requirements would depend on the diversity of CO<sub>2</sub> sources in a particular cluster, which increases the likelihood of CO<sub>2</sub> mixing issues. The other issues to be handled are the concentration of non-condensable and inert impurities such as nitrogen and argon, that have an effect on pipeline and reservoir capacity.

### 5.6.2 Financial Risks

#### 5.6.2.1 Cost of Capture

The main cost driver in the CCUS value chain is the capture cost. In industrial processes such as natural gas processing and gasification, carbon capture is part of the process itself and hence there is no additional cost of carbon capture. However, in the case of thermal power plants and other industrial processes, there are significant capital and cash costs, leading to financial risks for the entire CCUS value chain, which need to be mitigated through suitable commercial arrangements.

Significant resources have been invested in developing more efficient and cost-effective carbon capture technologies, and the cost range for most commercial-scale carbon capture technologies is well established. It may be worthwhile to focus further R&D efforts on finding creative ways to sell or consume the CO<sub>2</sub> product in new ways or optimize opex through low-cost sources of low-grade heat/steam for solvent regeneration and meet the electricity duty requirements of other carbon capture technologies.

#### 5.6.2.2 Financing Risks

The CCUS value chain consists of several connected sub-systems and functions that must act in coordination for the overall success of the project. Multiple sources or sinks in a cluster mitigate the risk and may require more elaborate transport and storage infrastructure, leading to higher capital costs and financing requirements, particularly in the early “anchor” stages of the project. The risk of financing delays or inadequacy leads to cost escalation and hence needs to be mitigated through measures such as meticulous planning, access to bridge financing during the early stage of the project and making realistic provisions for additional funding to cover the contingency of delays.

#### 5.6.2.3 Loss of Storage Site

Complications during CO<sub>2</sub> injection may lead to the stoppage of operations at CO<sub>2</sub> storage sites. Although reservoir management should provide adequate warning of such occurrences, there are technical risks in

estimating/predicting the final capacity of a new storage site with certainty. Relying on a single site or a single well is a key technical risk. Hence there is a need to prove new storage sites to ensure continued operations.

Careful long-term planning and contracting of multiple sites can mitigate this risk. Drilling additional wells or temporarily increasing the injectivity of existing wells can boost the short-term capacity of alternate sites. Hence, it is recommended that contingency plans be developed for additional storage capacity via additional wells or reservoirs. If rigs and requisite well supplies are available, new wells can be drilled and completed fast. It is therefore prudent to ensure rapid access to drilling rather than storing spare wells, as well as developing and assessing multiple storage locations.

#### 5.6.2.4 Price of Green Products

The issue of “inadequate prices” for low carbon or green products is a major risk factor. To address this risk, renewable energy has widely used feed-in tariffs, but only until it became cost-competitive. The tariff is paid centrally and passed on to consumers via taxation or a general price increase. However, the system is inflexible as the pre-determined feed-in tariff rates may become inappropriate and may need to be lowered. Ultimately the higher costs for the commitment for green products has to be passed on to customers and businesses, since the Government’s revenues comes from citizens and businesses.

#### 5.6.2.5 Lack of Tradeable Long Term CO<sub>2</sub> Emission Reduction

CCUS ensures long-term emission reductions and requires long term investments and financing having time horizons of up to 40 years. There is a need to design financial instruments where the payoffs/rewards are directly related to CO<sub>2</sub> abatement levels. The probable investors/buyers would be organizations that need to achieve future carbon reductions. The potential to invest directly in the best CCUS locations/projects should be less expensive than purchasing abatement certificates. There is thus a need to structure financial products directly linked to specific CO<sub>2</sub> abatement, transportation, and storage quantities, which can be marketed to different types of investors (viz. individuals, institutions and industrial enterprises), and preferably in a globally tradable manner.

#### 5.6.2.6 Withdrawal of Key Partners & Delay

The CCUS value chain requires the interplay and association of multiple partners and the

withdrawal/loss of a partner in the value chain can compromise the entire system. Contracts need to be designed to prevent the same, as well as protect the project from changes in ownership or divestments. However, there is the residual risk of a business partner’s insolvency or business failure. One model could be to centralize the core activities related to the CCUS value chain within one dedicated well-funded organization (with a lower probability of failure or disruption) rather than having multiple partner organizations and procuring the balance support services from the market.

### 5.6.3 Safety Risks

#### 5.6.3.1 Pipeline Incidents

Pipeline related accidents and incidents are significant safety risks and need to be mitigated through adequate insurance to cover the costs of paying compensation to affected parties and the cost of repairing the pipeline. Permanent disruption or permanent stoppage of CO<sub>2</sub> transportation may occur if the entire CCUS facility/infrastructure has been destroyed.

The effect of one pipeline incident may spill over to the development of the CCUS industry and operations of already commissioned CCUS facilities, who would need to upgrade their operations and safety protocols. Fortunately, there have been no major failures or disasters to date in the CCUS industry. At the same time, it is necessary for strict international safety standards to be adopted to preemptively avoid any incident. The safety standards followed in the international seaborne movement of LNG provides an excellent example worth emulating.

#### 5.6.3.2 Large Dia Pipeline in Populated Areas

Historical pipeline incident records reveal that larger diameter lines generally have a lower frequency of incidents. In order to avoid any incidents, automatic isolation valves at short intervals and leak monitoring systems are two solutions adopted by some projects. CO<sub>2</sub> is not dangerous in moderate quantities and becomes life-threatening only above certain threshold levels. However, adequate safety and failsafe precautions need to be adopted for dense phase or supercritical CO<sub>2</sub> pipeline transport in populated areas, as may be required for developing large scale CCUS projects in densely populated countries like India, along with clearly defined and established emergency response and communication protocols.



## Chapter 6

# Investment & Financing Mechanism



## 6.1 Introduction

Financing CCUS projects can be quite challenging in a developing country like India, even with policy support, whether be it incentive or tax based. With an inherently lower ability to absorb reduced tax revenues than a developed nation like the USA, India would initially need to look for international financial support for CCUS projects. India should create a financial framework around the CCUS value chain to support and expedite carbon capture adoption across industries. This chapter discusses different options for financing CO<sub>2</sub> capture, utilization and storage projects in a subsidy-neutral way for achieving decarbonization and ensuring the sustainability of the Indian economy.

CCUS represents an unmatched opportunity for turbocharging the growth of the Indian economy through large-scale 'carbon-friendly' investments in the industrial sector. These investments will help create a clean-energy based industrial sector, potentially leading to the development of new technologies, skills and high-value employment opportunities in India. With time, the clean-energy industrial sector will develop expertise and value-added low-carbon products that can be exported to other countries. CCUS also provides an opportunity for private enterprises to invest in the development of a new low-carbon emissions industrial infrastructure that will provide increasing returns on investments as the industry develops over time.

An active energy market backed up with a proper national CCUS policy to support the entire chain of operations can attract investments. This has to be ensured by designing 'Integrated Energy' policies that support primary manufacturing industries along with CCUS, leading to energy and materials security for India and attracting diverse foreign enterprises and private equity companies to engage in sustainable energy businesses in India.

## 6.2 Estimation of Capital Costs and Cash Costs for Demo Scale CCUS Projects

To support CCUS in India, it is important to fund and support demonstration scale projects. This section estimates the capital costs and cash costs for one demo scale CCUS project in each of the sectors under consideration. The costs vary widely, as even with the same CO<sub>2</sub> stream, carbon capture cash costs vary widely depending on the unit costs of power and

steam. The basis of estimation of the capital and cash costs is listed below:

- It is envisaged that the proposed carbon capture projects/units will be retrofitted to existing plants/units
- All the cost parameters are based on currently available technologies and Indian conditions & costs
- All auxiliary facilities like pre-treatment of gases or compression are considered as part of the carbon capture project
- Power required for the carbon capture project will be sourced from existing operations
- The steam requirements of the carbon capture project will be met from natural gas-based boilers for refineries or petrochemical projects and from coal-based boilers for other sectors
- For carbon capture projects for existing power plants, the steam will be sourced from existing power plant operations. The cost of steam will be considered at the opportunity cost
- Costs towards manpower, solvent make up, consumables, repair & maintenance, cooling water, make up water etc. have been considered on a normative basis for Indian conditions and costs
- The capital costs for the carbon capture units include all the hard and soft costs, including applicable taxes & duties, owner's cost, financing cost
- Capital recovery factor (CRF) has been estimated on the basis of 8% financing cost and 20 years of life
- The utility costs considered are shown in Figure 6-1.

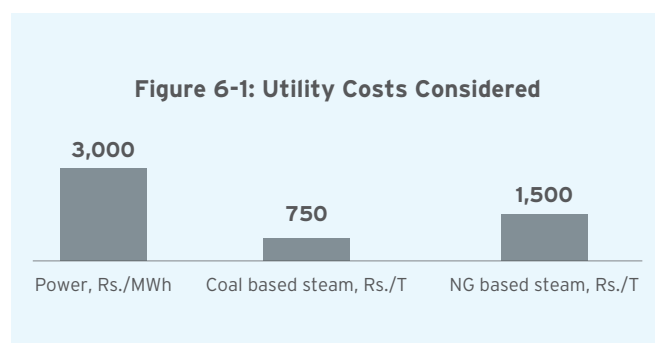

The key considerations for calculations of the capital and cash costs for CCUS units in each sector/application is provided below:

**Table 6-1: Capex and Opex Considerations for CCUS Retrofit**

Sector	CO <sub>2</sub> stream sources	CO <sub>2</sub> stream spec.	Considerations
Gasification based production	Outlet of the acid gas removal unit	<ul style="list-style-type: none"> <li>- 90% CO<sub>2</sub> conc</li> <li>- 1-5 bar (a) pressure</li> </ul>	<ul style="list-style-type: none"> <li>- CO<sub>2</sub> removal and capture are part of the process.</li> <li>- CCUS unit will undertake purification and compression of high conc. CO<sub>2</sub> stream for further disposition</li> <li>- Accordingly, only CO<sub>2</sub> polishing and compression facilities have been considered</li> </ul>
NG based SMR for H <sub>2</sub> production	Tail gas from PSA	<ul style="list-style-type: none"> <li>- ~65%+ CO<sub>2</sub> conc.</li> <li>- Near atm. pressure</li> </ul>	<ul style="list-style-type: none"> <li>- Depending on the extent of decarbonization targeted, the carbon capture source and technology will change. While CO<sub>2</sub> capture from tail gas will give the lowest capture cost for around 60% CO<sub>2</sub> reduction, capture from flue gas will ensure 95% capture with a higher cost of capture</li> <li>- Cryogenic separation has been considered for CO<sub>2</sub> capture from tail gas as it ensures high purity CO<sub>2</sub> (99.9%) with additional H<sub>2</sub> recovery</li> <li>- Overall CO<sub>2</sub> reduction will be limited to 60-70%</li> </ul>
Cement	Flue gas	<ul style="list-style-type: none"> <li>- ~20% CO<sub>2</sub> conc.</li> <li>- Near atm. pressure</li> </ul>	<ul style="list-style-type: none"> <li>- A hybrid (PSA + cryo) solution has been considered</li> </ul>
Iron and steel	BF gas	<ul style="list-style-type: none"> <li>- ~20% CO<sub>2</sub> conc.</li> <li>- Near atm. pressure</li> </ul>	<ul style="list-style-type: none"> <li>- An integrated steel plant has multiple CO<sub>2</sub> sources with different characteristics. However, pre-combustion capture from BF gas will ensure at least 50% capture with minimum cost of capture.</li> <li>- Water gas shift has been considered to ensure maximum CO<sub>2</sub> capture from a single point and potential H<sub>2</sub> recovery from the BF gas</li> </ul>
Refinery and chemical	Flue gas	<ul style="list-style-type: none"> <li>- 7-20% CO<sub>2</sub> conc.</li> <li>- Near atm. pressure</li> </ul>	<ul style="list-style-type: none"> <li>- Since a refinery has multiple sources of CO<sub>2</sub>, aggregation is difficult due different stream characteristics as well as space constraints of existing layout of typical refineries</li> <li>- CDU &amp; FCC unit are considered for carbon capture</li> <li>- Amine based carbon capture is considered to be the most economical solution</li> </ul>
Coal-based power	Flue gas	<ul style="list-style-type: none"> <li>- 8-15% CO<sub>2</sub> conc.</li> <li>- Near atm. pressure</li> </ul>	<ul style="list-style-type: none"> <li>- Amine based carbon capture considered</li> <li>- All retrofitting required for carbon capture like SO<sub>x</sub>, NO<sub>x</sub> removal, steam extraction, flue gas treatment has been considered as part of the carbon capture unit</li> </ul>

The typical capital costs for CCUS demo projects in each sector is tabulated below:

**Table 6-2: Sector-wise Typical Carbon Capture Capital Cost**

Sector	Ref. Plant capacity	CCU capacity	CO <sub>2</sub> intensity	CO <sub>2</sub> capture percentage	Capital Cost1	Source
Gasification based production	70 ktpa H <sub>2</sub>	1 mtpa	13-15 T/TH <sub>2</sub>	Around 90%	Rs. 80-100 Crore	- Dastur estimate for similar projects - Cost of capturing CO <sub>2</sub> from industrial sources (DOE/NETL-2013/1602)
NG based SMR for H <sub>2</sub> production	130 ktpa H <sub>2</sub>	0.7 mtpa	8-9 T/TH <sub>2</sub>	60-65%	Rs. 700-800 Crore	Dastur project database & IEA Technical Report
Cement	2.5 mtpa clinker	2 mtpa	0.7-0.9 T/Tclinker	Around 90%	Rs. 1,600 to 1800 Crore	Dastur project database & IEA Technical Report
Iron and steel	2.0 mtpa BF-BOF based ISP	2 mtpa	1.8-2.2 T/TSteel	Around 50%	Rs. 1,600-2,000 Crore	Dastur project database & IEA Technical Report
Refinery (CDU & FCC)	5 mtpa crude processing	1 mtpa	0.2 T/TCrude	Around 90%	Rs. 1,100-1,300 Crore	- Dastur estimate for similar facilities - IEA Technical Report
Coal-based power	800 MW	5 mtpa	0.85-1.1 T/MWh	Around 90%	Rs. 3,500-4,000 Crore	- Integrated Environmental Control Model (IECM) Version 11.5 - NETL - IEA Technical Report
<b>Total</b>		<b>11.7 mtpa</b>	-	-	<b>Rs. 8,600 - 10,000 Crore</b>	

**Note:** The capital costs are on a net of GST basis and include cost towards plant & equipment, construction cost, applicable taxes & duties, licensing cost, financing cost, owner's cost, etc.

Similarly, the typical cash costs for CCUS demo projects in each sector are tabulated below:

**Table 6-3: Sector-wise Typical Carbon Capture Cash Costs**

Sector	Electricity Consumption, kWh/TCO <sub>2</sub>	Steam Consumption, T/TCO <sub>2</sub>	Electricity Cost, Rs./TCO <sub>2</sub>	Steam Cost, Rs./TCO <sub>2</sub>	Other Costs, Rs./TCO <sub>2</sub>	Total Cash Costs, Rs./TCO <sub>2</sub>
Gasification based production	70-90	Negligible	210-270	Negligible	25-30	250-300
NG based SMR for H <sub>2</sub> production	220-250	Negligible	660-750	Negligible	450-600	1,150-1,400
Cement	340-370	Negligible	720-1,110	Negligible	300-450	1,050-1,600
Iron and steel	170-190	1.3-1.5	510-570	975-1125	400-600	1,900-2,300
Refinery (CDU & FCC)	110-130	1.2-1.5	330-390	1,800-2,250	500-700	2,700-3,100
Coal-based power	250-300	1.3-1.55	750-900	975-1,165	800-1000	2,100-2,500

**Note:**

- Other costs include costs towards water, consumables, repair & maintenance, manpower, and other miscellaneous items
- Typical cost numbers include the cash costs for carbon capture only. The cost of transportation, sequestration, monitoring, etc. will be an additional US\$ 10-15 per tonne depending on distance, sub-surface characteristics, etc. CO<sub>2</sub> quality of 100 bar(a) pressure and 95% plus purity has been assumed for all cases.

The sector-wise levelized cost of carbon capture per tonne of CO<sub>2</sub>, consisting of both capital charges and cash costs, is tabulated below.

**Table 6-4: Sector-wise Typical Carbon Capture Cash Costs and Capital Charges**

Industry name	Ref. Plant capacity	CCU capacity	Capital Charges (A), Rs./TCO <sub>2</sub>	Cash Costs (B), Rs./TCO <sub>2</sub>	Total Cost (A+B), Rs./TCO <sub>2</sub>
Gasification based production	70 ktpa H <sub>2</sub>	1 mtpa	90-120	250-300	340-420
NG based SMR for H <sub>2</sub> production	130 ktpa H <sub>2</sub>	0.7 mtpa	900-1,200	1,150-1,400	2,050-2,600
Cement	2.5 mtpa clinker	2 mtpa	800-1,000	1,050-1,600	1,800-2,600
Iron and steel	2.0 mtpa BF-BOF based ISP	2 mtpa	1,000-1,300	1,900-2,300	2,900-3,600
Refinery (CDU & FCC)	5 mtpa crude processing	1 mtpa	1,200-1,400	2,700-3,100	3,900-4,500
Coal-based power	800 MW	5 mtpa	700-1,000	2,100-2,500	2,800-3,500

## 6.3 Aggregate CCUS Investment Requirements at Country Level

CO<sub>2</sub> emissions in India from the hard to abate sectors like steel, cement, coal-based power, chemical, etc. is estimated to reach around 2,300 mtpa by the year

2030. The details of the CO<sub>2</sub> emissions from each sector are given in Figure 6-2.

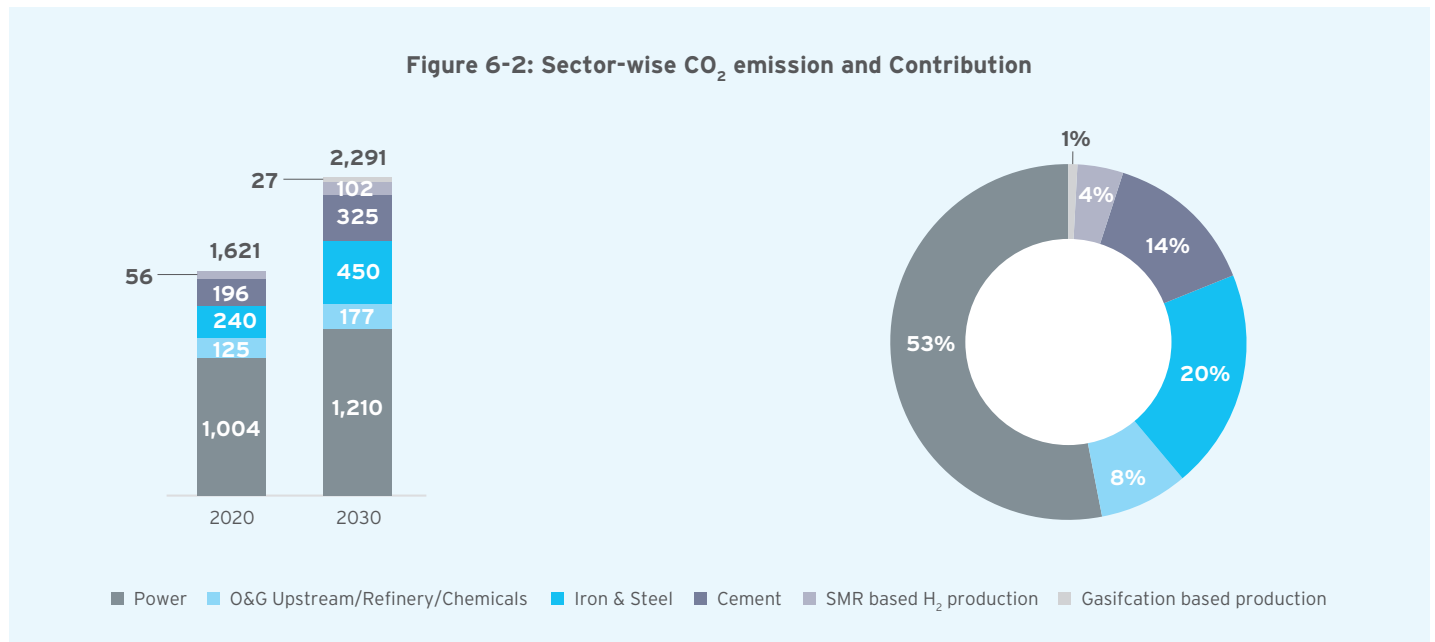

In addition to the investments required for funding demo scale projects, the aggregate CCUS investment requirements at the country level have been estimated for two scenarios of CO<sub>2</sub> abatement in the year 2030: the base case and the optimistic case. The investment numbers have been estimated based on typical sector-wise capital costs for carbon capture, CO<sub>2</sub> transportation pipeline and sequestration. While

the base case represents a carbon capture volume of 20 mtpa, the optimistic case represents a target of approximately 35 mtpa of carbon capture by 2030. The carbon capture volumes under the two scenarios are given in Table 6-5. The type of industry, the ease of implementation and likely cost impact has been considered while estimating the capital costs for each industry.



**Table 6-5: Carbon Capture Volume in Two Scenarios and Tentative Investment**

Industry	CO <sub>2</sub> Emissions in 2030, mtpa	CO <sub>2</sub> Capture in Base Case, mtpa	CO <sub>2</sub> Capture in Optimistic Case, mtpa
Gasification based production	27	4	10
SMR/ATR based H <sub>2</sub> production	102	2	2.5
Cement	325	2	2
Iron and Steel	450	4	5
Refinery and Chemical	177	-	0.5
Coal-based power	1,210	8	15
<b>Total</b>	<b>2,291</b>	<b>20</b>	<b>35</b>
<b>Investment Required</b>	BB\$	4.0	6.7
	Rs. crores	30,000	50,000

**Note:**

- For the gasification industry, carbon capture is part of the process. The high concentration CO<sub>2</sub> stream has to be purified and compressed for further disposition. Hence, only the capital cost of CO<sub>2</sub> purification and compression has been considered.
- Delivery pressure of product CO<sub>2</sub> is considered as 100 bar (a) for all cases.
- The capital costs have been calculated considering the capital cost for similar projects in different parts of the world and adapting the same to Indian costs and conditions.

The likely required investment in carbon capture will be 4 BB\$ (Rs. 30,000 crores) to 6.7 BB\$ (Rs. 50,000 crores), depending on the carbon capture volume. An additional amount of around 1.5 BB\$ (Rs. 11,000 crores) to 2.5 BB\$ (Rs. 19,000 crores) will be necessary for the transportation and storage infrastructure.

These estimates are based on the installation and costs of the best and commercial-scale technologies currently available. The investment can reduce with strategic aggregation at scale and the usage of common CCUS infrastructure. Further, improved scale and breakthrough novel technologies can also reduce the costs significantly.

## 6.4 CCUS Financing Mechanism

In the absence of any tax incentives or supporting market conditions for low carbon footprint products, emerging 'low-carbon' technologies cannot compete with traditional fossil fuel-based technologies. Under such scenarios, deploying public procurement programmes that favor low-carbon products or ensure a guaranteed minimum price for products generated from CCUS equipped operations, along with CO<sub>2</sub> tax credits, can provide the foundations of a level playing field for investors.

Incentives from the Government in the form of tax credits, cash credits, or Product Linked Incentives (PLI) can boost CCUS technology implementations. Figure 6-3 shows how incentives can create a level playing field for CCUS projects. Also, incentivizing investments through capture credits enables progressive reduction of capture costs and establishes markets for low carbon-based products.

**Figure 6-3: Incentives such as the Product Linked Incentive (PLI) scheme create a level playing field for low-carbon products**

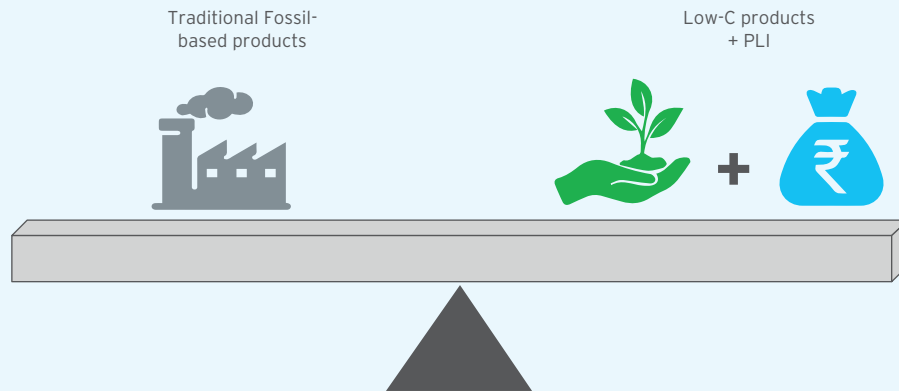

The decarbonization costs will have a varying impact on the unit cost/price of products in different industries, viz. power, cement, steel, etc. Hence it is suggested to have a well-considered policy that takes care of the CCUS cost structure in domestic and international markets and the decarbonization cost for each industry without compromising product competitiveness and India's industrial and economic development goals. An incentive for low-C production should be primarily guided by the following parameters:

- Carbon capture/abatement cost;
- CO<sub>2</sub> emission intensity of the conventional process;
- Cost structure of alternative process/production route (if any) for the production of green or low-C products; and
- India's energy security and sustainability goals.

While the initial demo scale projects can be funded through grants or project specific support, in the long term it is necessary to also create an institutional framework to finance and support CCUS projects at scale, so that CCUS can make a meaningful contribution to decarbonization and the clean energy future of India. Therefore, it is proposed to develop a "Carbon Capture Finance Corporation (CCFC)", as a financial institution which will participate in CCUS projects through equity or debt participation, with the

objective of supporting and realizing the carbon neutrality goal. The CCFC will be funded by low-cost sovereign or International Green Funds, Carbon Bonds or Climate Funds. By investing in CCUS projects, along with a part of the incremental tax revenue generated, it should be possible to fund the carbon capture credits, eventually leading to subsidy-neutral CCUS operations.

As a signatory of the Paris Agreement of 2015, India has committed to reducing CO<sub>2</sub> emissions by 50% by the year 2050 and reaching net zero by 2070. Given the trajectory of capturable CO<sub>2</sub> emissions, this study envisions that at least 30% of the emissions should be captured through CCUS projects, for CCUS to make a meaningful contribution and providing a pathway for reaching net zero by the year 2070. Thus, a CCUS target volume of 750 mtpa has been considered for analyzing the institutional financial frameworks required to support the lofty and ambitious goal of net zero by 2070.

Two financing options have been evaluated and analyzed for CCUS financing with the target CCUS volume of 750 mtpa. A general schematic has been presented in Figure 6-4.

**Financing Option 1:** CCUS financing through only the 'Clean Energy Cess'

**Financing Option 2:** CCUS financing through bond and gross budgetary support

Figure 6-4: CCUS Financing Mechanism

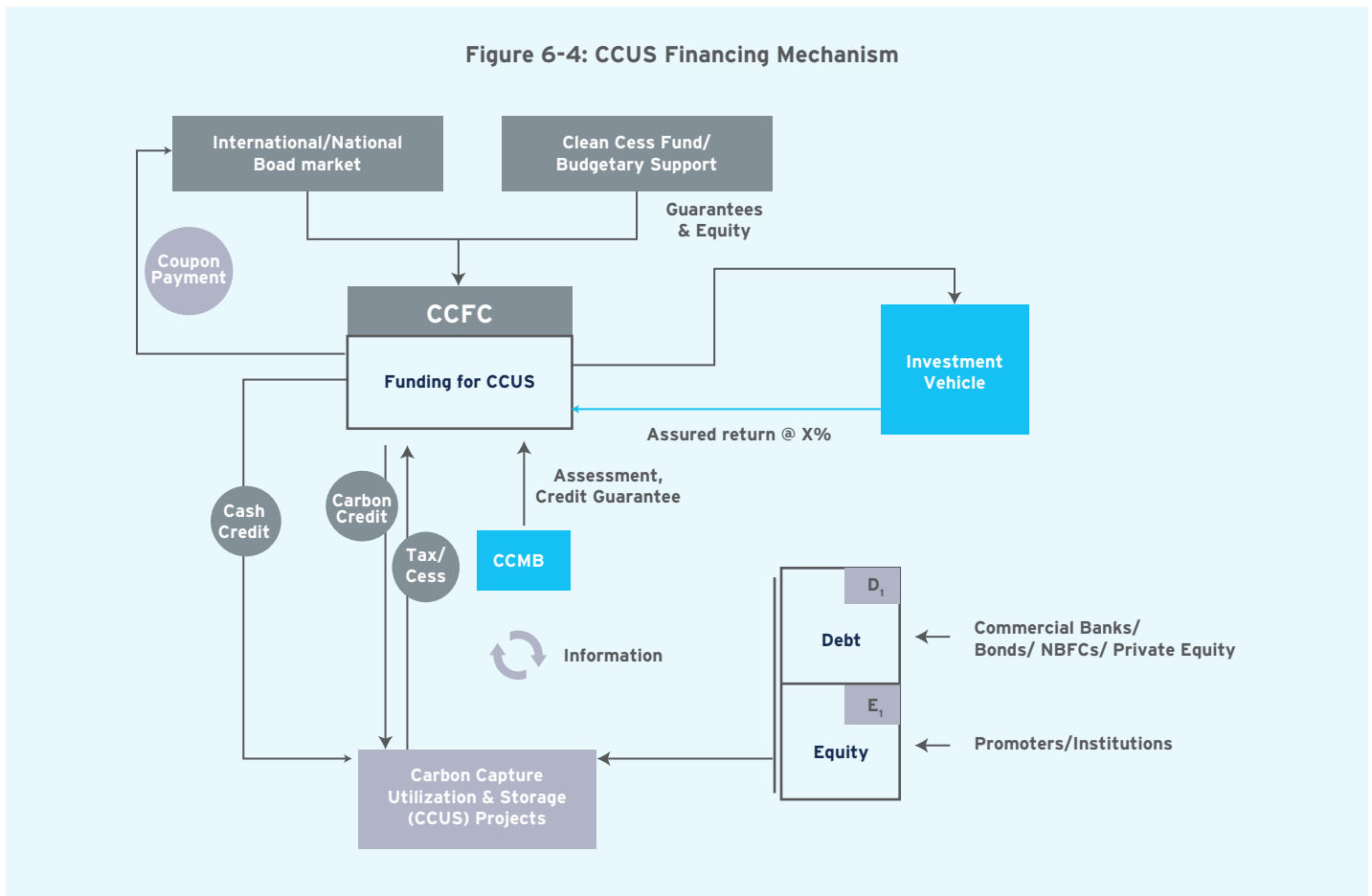

In both options, it is proposed to develop the CCFC with seed funding and support from the Government of India. The surplus funds will be re-financed to generate earnings at an 8-10% spread. The CCFC will subsidize the cash costs of CCUS projects through cash credit, while the capital charges will be subsidized as a tax credit. Since the cash credit and tax credit required for each industry will be different and critical for the adoption of CCUS, it is proposed to finalize the same based on CCUS demonstration projects based on different technologies, FEED study for the projects and discussion with industries. The tax credit created by the CCUS projects can be either availed by the parent company or can be sold in the 'carbon market'.

**In financing option 1**, it is assumed that the 'Clean Energy Cess' on coal @ USD 5.3/tonne (Rs. 400 per tonne) will be re-introduced from 1 April 2026, as the GST compensation cess has been extended till 31

March 2026. India's coal and coke consumption is expected to increase from the current 1,050 mtpa to around 1,200 mtpa by 2030 at a 2% CAGR. Accordingly, the annual cess collection is estimated to be around USD 6-7 BB\$ (Rs. 48,000 - 53,000 crores). The maximum cash credit requirement by the year 2030 is estimated to be around USD 2 BB\$ (Rs. 15,000 crores) considering the optimistic case i.e 35 mtpa of capture and disposition. So, the surplus funds in the initial period will create an opportunity for the CCFC to grow the corpus significantly through re-financing through appropriate investment vehicles.

**In financing option 2**, the Government budget and bonds will finance the subsidy (cash and tax credits) required for CCUS. It is estimated that 30.50 BB\$ (Rs. 2,29,000 crores) of bonds with a 9% spread in re-investment return, along with a maximum of 0.5% of the Government's spending or the 'Gross Budgetary Support (GBS)' can finance 750 mtpa of CCUS by 2050.

It is proposed that the bonds will be raised from the low-cost national/international bond market and invested in green projects in India with an assured return of 9% spread. While the bonds will be raised and re-invested in the initial years, the projected utilization has been estimated to limit the government

spending on CCUS to be less than 0.5% of the “Gross Budgetary Support”.

The assumptions/considerations and the results of the analysis are presented below.

**Table 6-6: Assumptions/Considerations for CCUS Financing Analysis**

Parameters	Remarks
Current CO <sub>2</sub> emissions from industries & power sector	1600 mtpa
CAGR of CO <sub>2</sub> emissions	4% till 2030 2% from 2031-40 1% from 2041-50
Capturable CO <sub>2</sub>	85% of emissions
Current coal consumption	1050 mtpa
CAGR of coal consumption	2% till 2035, no increase after that
Clean energy cess	400 Rs./tonne Existing rate of Rs. 400/tonne, to be effective from 1 April 2026
Subsidy for storage	4.1k Rs./tonne till 2040 3.0k Rs./tonne till 2050 Based on the average CCUS cost for industries and power
Subsidy for EOR usage	3.0k Rs./tonne till 2040 2.4k Rs./tonne till 2050 Based on the average CCUS cost for industries and power, adjusted for benefits from EOR
Subsidy for utilization for value-added products	2.3k Rs./tonne Based on average CCUS cost for industries and power, adjusted for benefits from value-added product
Return on corpus/bond re-investment	9%
GDP growth rate	8% till 2030 5% for 2031-2050
Govt. expenditure as a percentage of GDP	18% Based on the FY 2022-23 budget allocation

**Figure 6-5: Results of CCUS Financing Analysis - Financing Option 1 (Clean Energy Cess)**

**CO<sub>2</sub> capture progression, in mtpa**

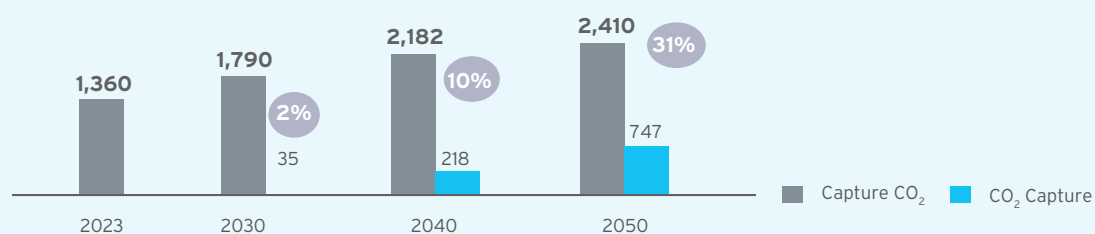

**Coal consumption & 'Clean Energy Cess' Collection**

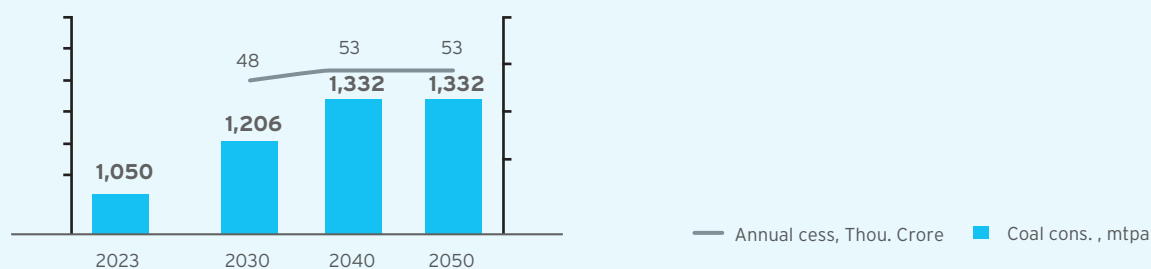

**Clean energy cess fund with re-investment @9%, Thou. crore**

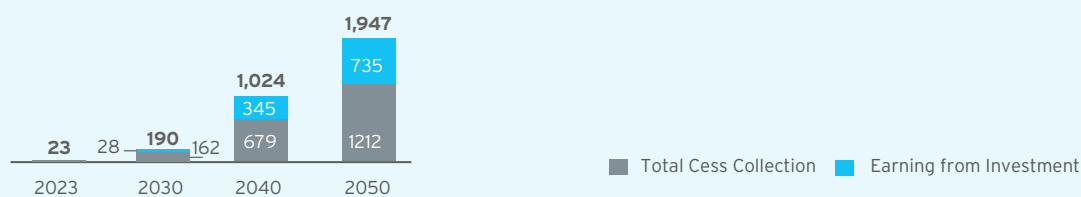

Year	Fund. Req., Thou. crore	Bond With Return, Thou. crore	Gross Budgetary Support (GBS), Thou. crore
2023	-	23	23
2030	15	169	154
2040	89	603	514
2050	210	225	15

**Figure 6-5: Results of CCUS Financing Analysis - Financing Option 2 (Bonds and Govt. Budget Support)**

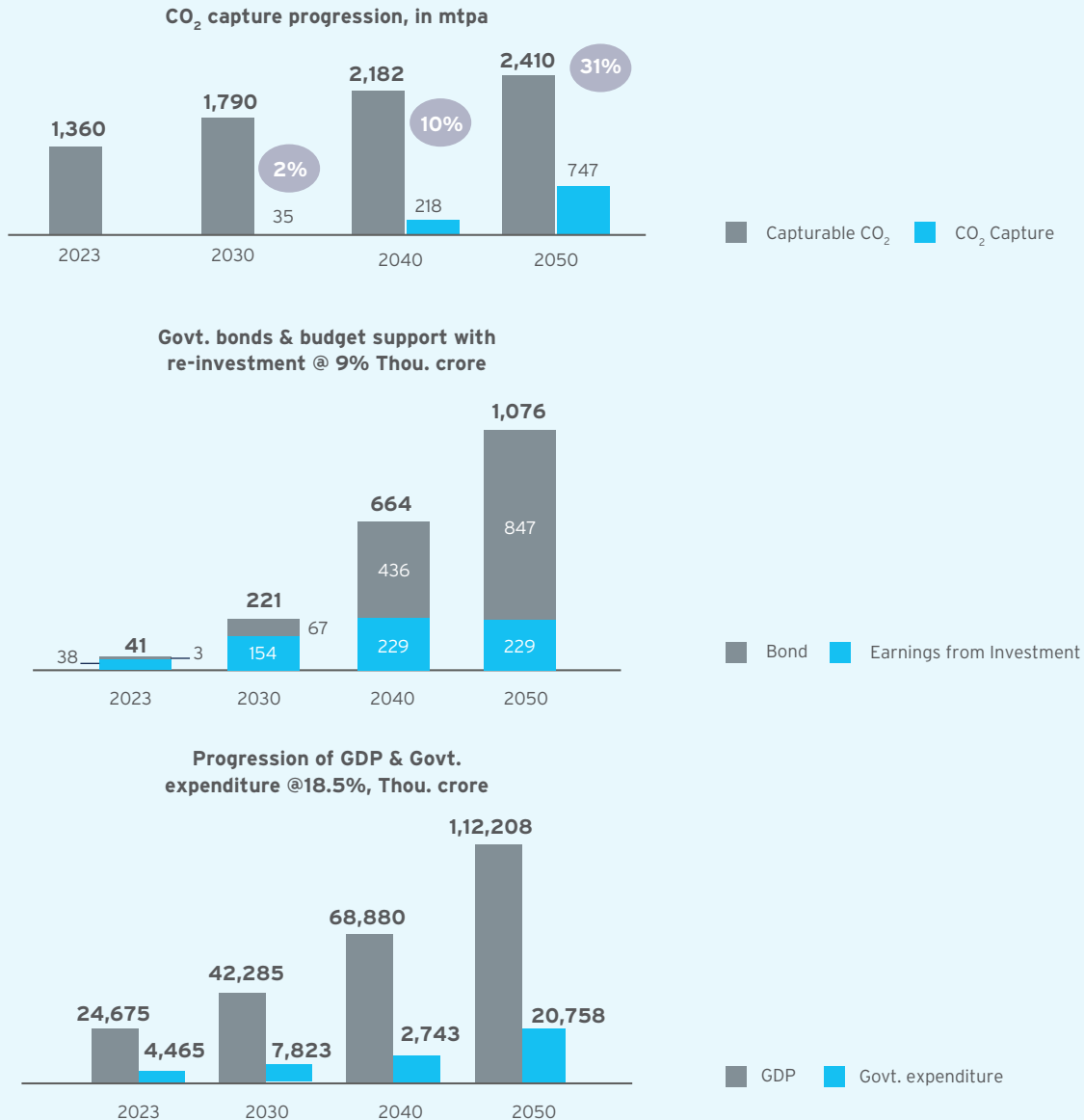

Year	Fund. Req., Thou.crore	Bond With Return, Thou. crore	Gross Budgetary Support (GBS), Thou. crore
2023	-	-	-
2030	15	-	15 (0.2% of GBS)
2040	89	36	53 (0.4% of GBS)
2050	210	107	103 (0.5% of GBS)



## 6.5 Carbon Capture Finance Corporation (CCFC)

It is proposed that the Government of India set-up a financial institution for the promotion and development of CCUS projects in India. The financial institution, which can be called the “Carbon Capture Finance Corporation (CCFC)” shall provide tax and cash credits for carbon capture projects in India. The CCFC may also participate in certain carbon capture projects through equity and debt funding & financing. Whilst the detailing the implementation framework for the CCFC is a separate exercise, the salient features of the envisaged framework are enumerated below:

- i) Timelines:** It is envisaged that the CCFC should be set up by the year 2023 or 2024 to kick start CCUS projects in India and continue to support carbon capture projects till the year 2050, i.e. the target year for CCUS volumes to reach 750 mtpa or about 30% of the capturable emissions in 2050. In this context, it may be noted that the 45Q carbon tax credits prevailing in the US originally came into vogue in 2008 and their validity was extended from 1 January 2026 to 1 January 2033 by the recent Inflation Reduction Act of 2022. The total timeframe for the 45Q credits is hence about 25 years, which is a reasonable timeframe to consider for CCUS to reach scale and make a meaningful contribution to India’s energy transition & decarbonization journey and also cover the depreciable project life of an infrastructure/CCUS project for recovering the capital costs. A similar timeframe from 2023 or 2024 to 2050 is also proposed for the CCFC in India, so that investors in CCUS projects have a long enough cash flow visibility over the depreciable life of the assets. Projects need to begin construction before a specified cut-off date to be eligible for the CO<sub>2</sub> credits.
- ii) Types of credits:** It is proposed that the CCFC shall extend both tax credits and cash credits to eligible CCUS projects; the tax credits shall be for the recovery of the capital costs and the cash credits shall be for the recovery of the operating costs of CCUS projects. In this context, it may be noted that similar incentives are already available in India for wind power projects. Wind power projects enjoy the benefit of Accelerated Depreciation (AD), which was first introduced as

early as 1994, with a depreciation rate of 100%. The depreciation rate was reduced to 80% in 2002 and the AD scheme was subsequently withdrawn in 2012. There was a steep reduction in wind sector capacity additions post 2012, and the scheme was re-introduced in 2014 (with an 80% depreciation benefit) and made applicable for plants installed on or after 1 April 2014. Additionally, Generation Based Incentives (GBI) has also been available for wind power to the extent of INR 0.50 per kWh for the period of up to 31 March 2022. A similar combination is also envisioned for CCUS projects, with the following features to maximize the envisaged CCUS outcomes:

- a. Combination of Accelerated Depreciation (AD) and GBI:** A combination of AD and GBI may be provided, with the caveat the CCUS projects should operate at a certain minimum level of utilization to be eligible for the AD; else the AD shall be recovered along with interest.
- b. Capital cost recovery:** Tax credits such as AD for the recovery of capital costs & charges should reward actual performance and CO<sub>2</sub> tonnage abated, rather than just capacity addition, regardless of actual operating performance. This will also incentivize project proponents and by extension, technology providers to invest time and effort in reducing capital costs over time.
- c. Adequate monitoring/auditing mechanisms:** There should be mechanisms for monitoring and auditing the reported performance of CCUS projects through independent organizations, since both tax credits and cash credits shall be tied to actual operating performance.
- d. Transferability of tax credits:** The tax credit should be tradeable or transferable to third parties in lieu of cash. This ensures a market for the tax credits so that even emitters which may not have a tax liability have incentives to participate in CCUS projects.

**iii) Level of credits:** The 45Q tax credits offered in the USA may serve as a reference point for the level of tax credits offered for carbon capture utilization and sequestration projects. The recently enacted Inflation Reduction Act of 2022 has substantially enhanced the maximum level of credits available from US\$ 50 to US\$ 85 per

tonne of CO<sub>2</sub> sequestered. However, the level of credits are the same irrespective of the source and concentration of the CO<sub>2</sub> captured and creates a disparity of incentives for different types of emitters, viz. an ethanol plant with almost 100% pure CO<sub>2</sub> vs. a coal based power plant with 8-15% CO<sub>2</sub> concentration in the flue gas stream.

**Table 6-7: 45Q Tax Credit Amounts**

Year	Carbon Captured and Sequestered (\$/metric ton)					Carbon Captured and Used (\$/metric ton)				
	Prior Law	IRA for Industrial Capture		IRA for Direct Air Capture		Prior Law	IRA for Industrial Capture		IRA for Direct Air Capture	
		Base	Bonus	Base	Bonus		Base	Bonus	Base	Bonus
2022	\$37.86	\$17	\$85	\$36	\$180	\$25.13	\$12	\$60	\$26	\$130
2023	\$40.90	\$17	\$85	\$36	\$180	\$27.59	\$12	\$60	\$26	\$130
2024	\$43.94	\$17	\$85	\$36	\$180	\$30.05	\$12	\$60	\$26	\$130
2025	\$46.98	\$17	\$85	\$36	\$180	\$32.51	\$12	\$60	\$26	\$130
2026	\$50.00	\$17	\$85	\$36	\$180	\$35.00	\$12	\$60	\$26	\$130
2027+	\$50.00 as adjusted for inflation	\$17	\$85	\$36	\$180	\$35.00 as adjusted for inflation	\$12	\$60	\$26	\$130

Given this backdrop, it is suggested to have different levels of credit for each industry, depending on the CO<sub>2</sub> concentration & pressure, power & steam penalties, Scope 2 emissions, technology maturity and the typical cost of capture. Since carbon capture projects are still at the pilot stage in India (except for fertilizer and gasification plants), FEED studies and actual demonstration stage projects are required to finalize the level of credits that are provided. It may also be worthwhile to look at providing incentives for emerging technologies in the areas of carbon utilization as well as direct air capture, to promote their development and implementation in India.

**iv) Production Linked Incentive (PLI):** An alternative to tax and cash credits is offering production linked incentives or PLI to carbon abated products. The PLI scheme has been in vogue in India since March 2020 and is applicable to multiple manufacturing sectors, with benefits applicable for a period of four to six years. The goals of the PLI scheme are the creation of large scale manufacturing capacity in India, import substitution and employment generation, and resonate well with the goals of CCUS in India.

It is reported that the Government of India is contemplating extending the PLI scheme for the production of green hydrogen in India; the same should be considered for CCUS also. In order to implement PLI for CCUS projects, it is important to define the extent of PLI that will be available for different levels of decarbonization or abatement, and an independent organization would need to define the baselines and certify the

extent of decarbonization/greenness of the products for which the PLI is being claimed. An example is again provided by the Inflation Reduction Act of 2022, which provides hydrogen producers different levels of investment or production tax credits, depending on the extent of CO<sub>2</sub> produced per tonne of hydrogen, as tabulated below.

**Table 6-8: Tax Credits for Hydrogen Production in USA - Inflation Reduction Act of 2022**

Life Cycle CO <sub>2</sub> Emissions (kg of CO <sub>2</sub> e / kg of H <sub>2</sub> )	Investment tax credit	Production tax credit (2022 US\$ / kg of H <sub>2</sub> )
4 - 2.5	6%	\$0.60
2.5 - 1.5	7.5%	\$0.75
1.5 - 0.45	10%	\$1.00
0.45 - 0	30%	\$3.00

## 6.6 Mechanisms for Promoting Coal Gasification Projects with CCUS

Coal gasification (with CCUS) is an important and strategic sector for ensuring the future energy and materials security of India and reduce import-dependence for critical chemicals and commodities. It is recommended to set up a special purpose organization to drive and promote coal gasification in India, including the production of blue hydrogen to enable the hydrogen economy. The key areas of focus for the envisaged SPV would be to conceptualize and strategize the implementation of coal gasification projects in emerging areas, identification and implementation of pilot and demo projects, arranging financing of projects, promoting and enabling policy research and advocacy, support start-ups etc. The organization may be formed with participation from the concerned PSUs from the Ministry of Coal, Ministry of Heavy Industries, Ministry of Steel, academic institutes and think tanks working in these areas.

Additionally, viable financing mechanisms may be adopted for promoting coal gasification and CCUS projects. A suggested mechanism is described below:

It is proposed to develop an institutional financing/ SPV framework supported by the Government of India. The illustrated SPV framework in the example below (Figure 6-6) is based on mega-scale coal gasification-based projects that promote and accelerate the adoption of CCUS, thus enabling a low-carbon economy. The SPV shall use equity and debt raised through the international bond markets to finance the carbon capture costs. The equity will be funded through the participation of sovereign funds, government bodies, and private investment bodies.

The SPV will act as a self-financing funding vehicle for integrated coal gasification and CCUS projects, with a likely fund size of between 5-10 BB\$ (Rs. 37,500 - 75,000 Crores). The coupon payment and equity return would be ensured from the returns on the SPV's investment in the gasification and CCUS economy.

**Figure 6-6: SPV Framework to Finance Gasification Projects in a Deficit-Neutral Way**

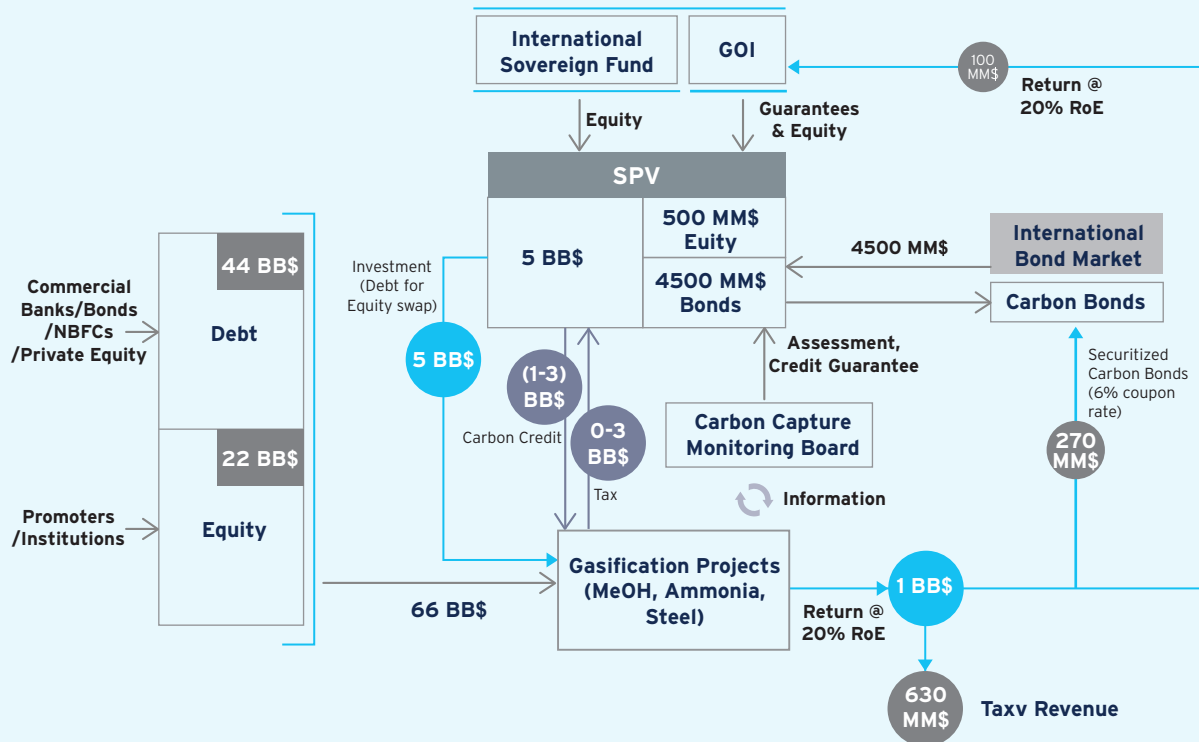

Source: Dastur research

The carbon credit incentives would be primarily offset by the tax generated from the indigenous coal gasification-based economy and generating value-added products like methanol, power, other chemicals, hydrogen, steel, and fertilizers. By investing the funds in the gasification economy, along with a part of the tax revenue generated from gasification-based operations, it should be possible to fund the carbon capture credits of 1-3 BB\$ (Rs. 7,500 - 22,5000 Crore)/year - eventually leading to subsidy-neutral CCUS operations. Also, investment in gasification projects will enable the SPV to access, monitor, and enforce CO<sub>2</sub> capture through a Carbon Capture Monitoring Board (CCMB). Additionally, the SPV will create revenue of ~ 0.6 BB\$ (Rs. 4,500 Crore) through innovative fund design.

The key recommendations for the CCUS financing framework are summarized below:

- A statutory body like the 'Bureau of Energy Efficiency (BEE)' needs to be created for the assessment, baselining, and monitoring of CO<sub>2</sub> emissions for each industry. It will also identify the best practices to reduce carbon footprint and design the incentive mechanism for the adoption of best practices and technologies.
- PLI for low carbon products should be linked with the decarbonization goal and the cost disadvantages of renewable-based/non-conventional greener production.

- c) The cost of CO<sub>2</sub> abatement will be subsidized through cash credits and tax credits. Cash costs will be subsidized as cash credits, while the capital cost will be subsidized through tax credits.
- d) The cash credit and tax credit levels should be different for different industries since the cost of capture varies widely depending on CO<sub>2</sub> concentration & pressure of sources, as well as technology selection and synergy with existing operations.
- e) Cash credit and tax credit numbers for each industry should be finalized based on demonstration projects and/or FEED studies. Demonstration projects are essential to find out the best technologies and the possible optimization through learning and R&D. FEED studies as well as implementation of demonstration plants should be supported by the Government through loan guarantees or a mandate for PSUs.
- f) The cash credit and tax credit mechanism should be reviewed every 3 to 5 years depending on the progress, adoption and challenges.
- g) Life cycle assessment (LCA) of CCU should be a mandatory evaluation criterion for finding out the best possible technologies. To implement LCA, an India-specific life cycle inventory database and a framework should be created on a priority basis.

## 6.7 Evaluation of Various Funding Sources

### 6.7.1 Green Bonds

Ever since its inception, the green bond market has seen significant growth, especially in the last five years. The growth has been fueled by the resolution of various nations and companies towards a net-zero economy. The year 2021 saw outstanding participation of investors in the green bond market, as a result of which the green bond market rose to over USD 517 BB\$ (from USD 350 BB\$ in 2020). This is the highest since the market's inception (source: climatebonds.net). With more investors joining the bond market, many developing nations and emerging economies like India are introducing sovereign green

bonds. Companies can also issue green bonds to raise funds for environmentally sustainable projects. Green bonds have attracted considerable attention in India since it was first issued in 2015. In 2021, India had the highest issuance of green bonds since 2015, amounting to USD 6.11 BB\$. With India's plans to introduce sovereign green bonds in FY 2022-23, it could attract a significant number of investments from foreign green bonds, hedge funds, investors, etc. Being an emerging market, India has a tremendous economic growth potential which is attractive to foreign investors. A portion of the money raised from these bonds could be utilized for funding CCUS projects and cluster development.

### 6.7.2 Clean Technology Fund (CTF)

The CTF fund is a USD 5.3 BB\$ fund and a part of Climate Investment Funds. The fund is aimed at supporting low carbon technology and upscaling to mitigate long term GHG emissions. 85% of the funds are approved for projects in renewable energy, energy efficiency and clean transportation sector. The fund has supported low carbon projects in 19 countries. In India, the CTF investment plan is worth USD 775 MM\$ and a large share of it has supported the development of 3 GW solar power capacity and supporting transmission infrastructure (source: climateinvestmentfunds.org).

### 6.7.3 National Clean Energy and Environment Fund (NCEEF)

The NCEEF was formulated and announced in the Finance Bill of FY 2010-2011; it was then known as National Clean Energy Fund (NCEF). The fund was sourced from the coal cess collected from coal producers and importers, and cess from other industries like pan masala, tobacco, aerated water etc., to finance India's transition to a low carbon economy. Apart from renewables and energy efficiency-related projects, the fund has also identified CCUS and coal gasification projects as eligible for funding. However, these funds had been diverted to support the Goods and Services Tax (Compensation to States) Act 2017 to compensate the states for five years (thereafter extended) for potential losses on account of GST implementation. This extended period is expected to end in 2026, after which the funds are expected to be utilized to support low carbon technologies and projects.

### 6.7.4 Carbon Capture and Storage Fund

This fund is managed by ADB and was started as a single partner fund with Australia as a partner in 2009; The United Kingdom subsequently joined the fund in 2012, making this a multi-partner trust fund. The fund was established for accelerating CCS technology demonstration, aiding in the identification and reduction/elimination of possible country-specific barriers to CCS technology demonstrations and mitigating the real or perceived risks related to carbon capture, transport or storage technology demonstration. The fund supports capacity development, geological investigations, and social awareness and support programmes. All ADB developing member countries are eligible to receive support through this fund, with priority given to India and other Asian countries like the People's Republic of China, Indonesia, and Vietnam. (source adb.org)

## 6.8 Private Investment Requirements

Identification of the right financing partners is critical to the success of CCUS projects. Based on the financial analysis of projects, the weightage of equity and debt financing for projects must be decided. Sources of equity financing can be large government/ private corporations owning the emitter projects (steel, cement, power plants, fertilizer & chemical plant owners), carbon capture technology suppliers working on Build Own Operate (BOO) model and CO<sub>2</sub> storage site owners. Debt financing can be obtained from various financial institutions like banks, hedge funds, financial corporations, etc.

### 6.8.1 Potential Sources of Debt

#### 6.8.1.1 Project Finance Loans

Project lenders, typically banks and insurance corporations with both their sources of funding and debt raised from public and institutional investors, provide most of the capital needed for project finance. In Indian projects, project lenders are in the form of commercial banks, regional banks, investment banks, and even hedge funds. Examples include:

- a) The Life Insurance Corporation (LIC) is the doyen of the insurance industry in India, with a total of INR 31 Lakh cr (almost USD 410 BB\$) in AUM. They have invested in infrastructure and industrial projects, including running several dedicated infrastructure and industrial funds, and could be a source of funds for CCUS projects.
- b) MUFG is the largest Japanese bank and has been operating in India since 1953. It has recently renewed its commitment to Indian corporates and projects with its move to its new 30,000 ft headquarters in BKC in Mumbai. With USD 17 BB\$ in sustainable investments globally and a long record of investing in developing countries, including India, MUFG could be a source of funds for CCUS projects.
- c) BNP Paribas has been around since the 1850s and is a tour de force in Europe's investing landscape, with about EURO 470 billion under management at the end of 2019. With a special focus on sustainable projects, BNP was the number 3 participant worldwide in the green bond market at the end of 2019 and signed 3.7 billion euros of Sustainability Linked Loans at the end of 2019, a financing instrument indexed on environmental, social, and governance (ESG) criteria. They were awarded World's Best Bank for corporate responsibility in 2019 by Euromoney and can be a potential source for project finance for CCUS projects and CCUS cluster development.

#### 6.8.1.2 Commercial Bank Long Tenor Loans

Commercial banks raise funds from customer deposits and allocate a part of their portfolio to long-tenured industrial loans for infrastructure and industrial projects. This group would include:

- a) Indian Nationalized Banks like State Bank of India (SBI), Punjab National bank (PNB), and others.
- b) Foreign banks such as FAB, Credit Suisse, JP Morgan, HSBC, Lloyds banking group and Goldman Sachs, and others.

#### 6.8.1.3 Development Financial Loans

Development finance loans are more specialized and typically originate from banks and corporations with lending mandates for sustainable development and emerging markets. Examples are:



- a) **International Finance Corporation (IFC):** One of the earliest corporations to issue a green bond in 2010, through its Green Bond Programme. IFC has issued USD 10.50 BB\$ across 178 bonds in 20 currencies. Being one of the largest financiers for climate-smart projects, IFC has supported these initiatives and projects with more than USD 28 BB\$ in long-term financing.
- b) **The World Bank:** With USD 17 BB\$ equivalent, the World Bank is one of the largest issuing bodies for green bonds. They have issued green bonds through 200 bonds in 24 currencies. The main objectives of the World Bank CCS Capacity Building Trust Fund (WB CCS TF) is to support capacity and knowledge building around CCS in developing nations. It aims to help the developing countries to explore CCS potential and to integrate CCS options into their strategies and policies developed for sustainable growth. Close to USD 70 MM\$ of funds have been granted in two phases to developing countries like Mexico and South Africa for pilot demonstration of CCS.
- c) **Asian Development Bank (ADB):** The ADB works closely with governments and private bodies to support India's inclusive transformation. ADB has set up a Climate Change Fund (CCF), as an enabler to address environmental and climate challenges through participation in low-carbon and climate-resilient development. "From 2011 to 2020, the ADB has approved about USD 41.6 BB\$ in climate financing. ADB's own resources provided USD 36.2 BB\$, while external resources contributed almost USD 5.4 BB\$. ADB supports green growth in Asia and the Pacific through financing and innovative technologies. Through mechanisms such as the Climate Investment Funds, multilateral development banks have mobilized billions for climate action in developing countries.
- d) **European Investment Bank (EIB):** EIB has been operating in India since 1993 and has extended financial support towards a wide variety of themes, including climate action and sustainable economic development. With lifetime finance of over USD 4.45 BB\$ in India, they have made major investments in the transport and energy sector. EIB and SBI have jointly launched the 100 million climate action initiative to support MSMEs working in the clean energy sector, transport (EV), and circular economy projects.
- e) **US International Development Finance Corporation (USIDFC)** is America's development bank, partnering with private sector equipment suppliers and service providers to finance numerous projects in the developing world. USIDFC invests across sectors including energy, healthcare, critical infrastructure, and technology and provides the developing world with financially sound alternatives to unsustainable and irresponsible state-directed initiatives. In India, the USIDFC has been seeking investment opportunities in India's crucial sectors, including financial services, health infrastructure, food security, etc. A fund of around USD 350 MM\$ has been earmarked for the same. The development bank of America has already approved loans of around USD 142 MM\$ for one of India's leading renewable energy IPP (Independent Power Producer), ReNew Power, and also has loans with Sitara Solar Energy to build solar power plants in Rajasthan.
- f) **Glasgow Financial Alliance for Net Zero (GFANZ)** consists of more than 450 leading financial institutions representing over USD 130 trillion in assets across the globe in various financial sectors such as banks, asset managers, asset owners, insurers, and financial service providers (stock exchange, rating agencies, auditors and investment consultants), supporting the UN's Race to Zero campaign.

The GFANZ essentially provides a platform where financial firms can team up or work in partnership to discuss various issues and come up with innovative solutions that would support the decarbonization of the world economies, companies by accelerating green financing across the globe. They are also dedicated to mobilizing investment of private capital into emerging markets and developing countries. Furthermore, GFANZ consists of sector-specific alliances like Net Zero Banking Alliance, Net Zero Asset Managers Alliance, Net Zero Asset Owner Alliance, Net Zero Insurance Alliance, Net Zero Financial Service Providers Alliance, Net Zero Investment Consultants Initiative, and the Paris Aligned Investment Initiative. The financial institutions who are members of these alliances, based on their region of operations, can be potential sources of green funding for CCUS projects and cluster development.

#### 6.8.1.4 Export Credit Agencies

Financing CCUS projects in emerging markets can pose risks to foreign investors. Export Credit Agencies (ECA) can play a pivotal role in reducing the risk of investment/ debt financing for such projects by providing financing solutions and risk insurance. Examples include:

##### a. Export Import Bank of the United States

**(EXIM):** EXIM provides trade financing solutions, including export credit insurance, working capital guarantees, and guarantees of commercial loans to foreign buyers, to empower exporters of US goods and services. EXIM works closely with both US-based suppliers of equipment and services, as well as with foreign buyers of the same. US EXIM Bank is an independent federal agency that fills gaps in private export finance. The US EXIM Bank was first active in India in the 1950s and today supports a significant volume of US exports to India.

##### b. Nippon Export and Investment Insurance

**(NEXI):** NEXI is the official export credit agency of Japan. In 2019, NEXI launched a “Loan insurance for green innovation”. This insurance was made for the financing of projects in the field of environmental protection/ climate change prevention. This product has been designed specifically for Japanese companies (exporters or equity investors) who implement projects in the field of renewable energy, energy conservation, and projects utilizing new technologies that contribute to global environmental protection (like CCUS, hydrogen-related technology, fuel-cell).

#### 6.8.2 Potential Sources of Equity

- a. Large corporations like NTPC, RIL, Adani Group, IOCL, SAIL, Tata Steel, JSW, IFFCO, etc. can be equity investors in carbon capture projects constructed at their plants.
- b. Technology and operational investors like Air Liquide, Honeywell UOP, Mitsubishi Heavy Industries Ltd., ION Clean Energy, Baker Hughes, etc. can be equity partners in such projects.
- c. Sequestration/EOR site operators like crude oil and natural gas producers (ONGC) can be equity investors in carbon capture and cluster development projects, as they will be utilizing the captured CO<sub>2</sub> for EOR.

## 6.9 Socio-Economic Impact of CCUS

The socio-economic impact of the CCUS project is manifold. CCUS will help in the production of low-C products through the decarbonization of hard-to-abate industries and power plants. Thus, it will create export opportunities for green products with a significant premium and also enable new coal-based industries such as gasification-based production of chemicals and power. At the same time, other manufacturing and service sectors will be benefitted from large investments across the carbon value chain (capture, processing, transportation, utilization, storage, and EOR). This will have a beneficial effect on existing as well as new industries.

With targeted capture of 750 mtpa by 2050, India could become a global leader in CCUS technology, thus creating significant export opportunities. Additionally, coal-based chemical production at a competitive cost can reduce the import of chemicals like methanol, ammonia, MEG, etc. This will reduce the foreign exchange outgo and also ensure energy security in future.

The additional oil produced from CO<sub>2</sub>-EOR will substitute crude oil imports to India and, therefore will decrease the current account deficit of India. Additionally, the direct and indirect tax revenues generated from the project and the incomes from direct and indirect employment will also generate significant tax revenues in India. Direct, indirect, and induced employment both during the engineering and construction phase will have a significant social and development multiplier. Although rigorous Input-Output modelling is not possible at this stage, the baseline parameters indicative of the socio-economic impact of the project are provided below:

- Economic Activity Parameters:
  - Value addition and GDP contribution
  - Investment and GDP contribution
  - Tax revenues
- Employment Generation Parameters:
  - Direct, indirect (including induced) and total employment during construction & operations
- Import Substitution Parameter:
  - Value of import of products substituted
  - Contribution to the reduction in current account deficit/surplus.

### 6.9.1 Net CO<sub>2</sub> Reduction from the Industrial & Power Sector

CCUS is the only sustainable and feasible solution to support India's growing demand for energy and rapid industrialization and meet the aspiration of over 1.3 billion Indians. The Indian industrial and power sector emits about 1.6 Gtpa of anthropogenic CO<sub>2</sub> today, which is expected to increase to 2.3 Gtpa by 2030

and 2.8 Gtpa by 2050. With the envisaged capture of around 0.75 Gtpa by 2050, CO<sub>2</sub> emissions will reduce by around 30%. Out of 0.75 Gtpa, a majority will be contributed by steel, cement and power industries in addition to new gasification-based industries. A probable distribution of 0.75 Gtpa across different sectors and the corresponding low-C production is shown in Table 6-9.

**Table 6-9: Probable Distribution of 750 mtpa and low-C Product Volume**

	Capture volume, mtpa	Equi. Low-C product
Thermal power generation	530	80-100 GW
Steel	100	40-50 mtpa
Cement	50	80-100 mtpa
Refineries & chemicals	10	40-60 mtpa
Hydrogen	10	~ 2 mtpa
Coal gasification	50	5 mtpa H <sub>2</sub> or 25 mtpa Methanol or 16 mtpa Ammonia
<b>Total</b>	<b>750</b>	

However, most of the currently available technologies for carbon capture are energy-intensive. Conventional technologies like amine-based carbon capture consume large quantities of steam for regeneration, while non-conventional technologies like PSA/cryo/membrane consume power. Since steam can only be produced efficiently through the burning of fossil fuels in boilers, there will be CO<sub>2</sub> emissions for steam production. With proper sourcing of steam and fuel selection, CO<sub>2</sub> emissions from boilers can be reduced, reducing the net CO<sub>2</sub> emission by 20-40%, depending on the industry. Waste heat recovery (if available) is ideal for the generation of steam, especially for cement and steel plants. On the other hand, Scope 2 emissions for electricity-based technologies will depend on the grid emission intensity. With the increased share of renewables, grid CO<sub>2</sub> intensity will reduce over time, which will benefit electricity-based technologies.

### 6.9.2 GDP & GVA Impact

A total of around USD 100-150 BB\$ [2022 dollars] of investments are required over the next few decades for 750 mtpa CO<sub>2</sub> capture, utilization, and storage. Since the investment will be across the CO<sub>2</sub> value chain, it will help develop the market for CO<sub>2</sub>. This preliminary estimation has been done based on the envisaged improvement of technology as well as cost reductions expected through indigenization. During the implementation stage, the impact on GDP has been assessed as US\$ 100 to 150 BB over the next 30 years.

Coal gasification projects will generate value-added products like methanol, ammonia, acetic acid, mono-ethylene glycol, etc. A significant part of these chemicals are presently imported to India; presently, India imports almost USD 13 BB\$ per annum of organic chemicals. Coal-based production through gasification will help in significantly reducing imports.

The contribution to the GDP from gasification-based products will be in the form of revenues from the production of methanol, ammonia, acetic acid, mono-ethylene glycol, etc. Revenues throughout the operating life cycle have been considered for estimating the GDP contribution from gasification projects. Depending on the product-mix (methanol/MEG/AA), coal based chemicals production can replace 7-10 BB\$ of imports by 2050.

Coal gasification projects will generate multiple tax streams for the Government exchequer. The major sources of tax, like the tax on the purchase of capital goods (during the construction stage) and the corporate tax (throughout the economic life of the project) have been assessed. Additionally, there will be a cascading effect due to the significant employment generation as well as economic development in the vicinity of the project, which is difficult to ascertain; hence the same has not been assessed.

Contribution to the GVA for value addition has been estimated as the revenue generated from the low-C products, less the cost for the intermediate inputs. The EBITDA (Earnings Before Interest Tax Depreciation and Amortization or the operating profits) throughout the economic life of the project have been used for calculating the GVA. Considering a minimum premium of 10% over conventional products, GVA for decarbonized products is estimated at around 10 BB\$.

### 6.9.3 Potential Direct & Indirect Employment Creation

During the construction stage, the generation of temporary employment for construction works (skilled, semi-skilled, and unskilled) will be one of the major impacts of CCUS projects. Additionally, high skilled and valued resources will be required by

contractors, technology suppliers, and project proponents for project management, administration, and supervision. The employment of construction workers from the nearby area will boost the regional economic conditions. As there is a multiplier effect on consumption, savings, taxes, etc. the projects will help in shaping the future economic development of the nearby areas. The indirect employment is likely to be 3-5X of the direct employment generated.

Additionally, jobs for O&M of the entire carbon value chain will progressively expand. These persons will mostly be skilled personnel and SMEs in the required fields. The total impact has been estimated based on the annual requirement of manpower multiplied by the economic life of the project, considered as 25 years of operations. As the indirect employment multiplier is a function of the salary, savings, and domestic consumption, indirect employment will be around 5-7X of the direct employment.

Based on the above, it is estimated that India's CCUS ambitious target of 750 mtpa by 2050 can create employment of over 8-10 million full time equivalent (FTE) years in a phased manner.

### 6.9.4 Potential FDI

Primary industries are capital cost intensive and CCUS will increase the cost further. CCUS implementation for a volume of 750 mtpa will cost more than 100 BB\$ over the next two to three decades. The Government of India should work with international partners, technology suppliers, policymakers, etc. to support India's decarbonization goal through technology transfer and financing capital cost-intensive CCUS projects. Additionally, decarbonization will gradually become one of the key criteria for attracting international financing. So, projects with CCUS may be able to secure low-cost financing from outside India.



## Chapter 7

# Conclusions

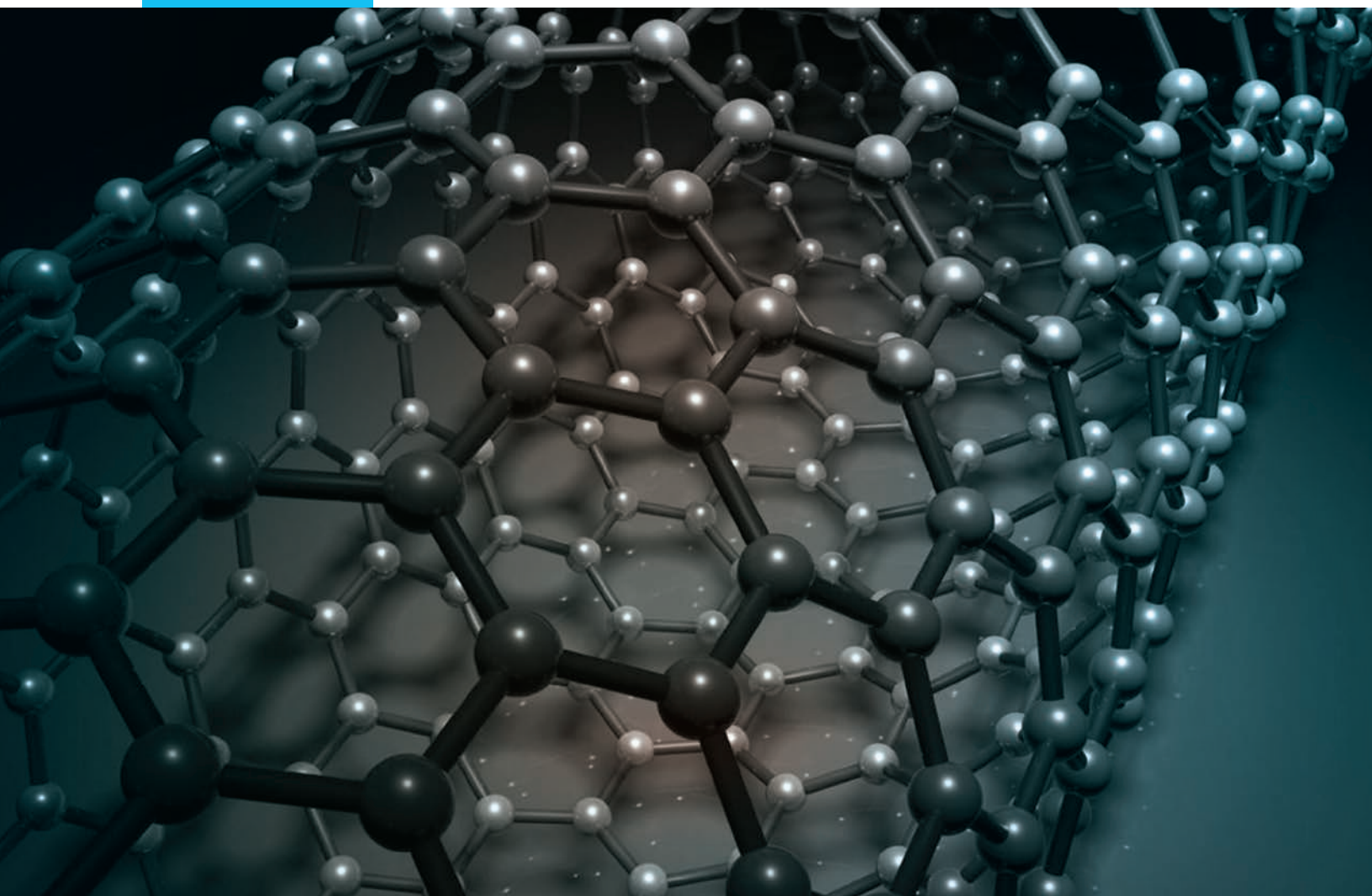

This chapter summarizes the findings and recommendations of this study, as below:

1. Carbon Capture Utilization and Storage (CCUS) has an important and critical role to play for India to halve CO<sub>2</sub> emissions by 2050 and accomplish net-zero by 2070, as envisioned by the Hon'ble Prime Minister of India. Energy transitions take decades and hence it is important to implement the framework and policy instruments for CCUS to become a reality in India and make a meaningful contribution to decarbonization in India.
2. CCUS is required for the decarbonization of both industrial applications and the power sector:
  - a. **Industrial applications:** Industrial applications are hard to electrify, and industrial CO<sub>2</sub> emissions are hard to abate due to the use of fossil fuels not only as a source of energy but within the process itself. Thus CCUS is imperative to decarbonize the industrial sector, which accounts for over 30% of total CO<sub>2</sub> emissions in India.
  - b. **Clean products:** CCUS can enable the production of clean products while utilizing our rich endowments of coal, reducing imports and thus leading to an आत्मनिर्भर Indian economy. CCUS also has an important role to play in enabling sunrise sectors such as coal gasification and the nascent hydrogen economy in India.
  - c. **Power:** India relies on coal for meeting over 70% of its electricity needs; even if India is able to meet the renewables target of 500 GW installed capacity by 2030, there would still be a need to meet baseload power demand from fossil fuels (most likely coal) or other dispatchable sources, given the intermittency and non-dispatchable nature of solar and wind power. Thus, CCUS has a role to play in enabling clean and green baseload power and ensuring the sustenance and non-stranding of our over 210 GW of coal and lignite-based thermal power plants.
3. CCUS can contribute to decarbonization and transition to clean energy systems in various ways:
  - a. Ensuring the sustenance of existing emitters
  - b. Decarbonizing hard to abate sectors
  - c. Promoting the low carbon hydrogen economy
  - d. Removal of the CO<sub>2</sub> stock from the atmosphere
4. Scope 1 emissions from India's power and industrial sectors (primarily steel, cement, H<sub>2</sub> production, oil & gas, refineries, chemicals and coal gasification) amount to 1,600 mtpa of CO<sub>2</sub>, which is around 60% of the total CO<sub>2</sub> emissions (2,600 mtpa) in India in 2020. The remaining 40% CO<sub>2</sub> emissions are contributed by distributed point emissions sources like agriculture, transport, and buildings, which are not amenable to carbon capture. Emissions from these sectors (power and industries) are expected to increase to nearly 2,300 mtpa by the year 2030, fuelled by India's strong GDP growth outlook.
5. The key CCUS related interventions required for the CO<sub>2</sub> intensive sectors of the Indian economy is tabulated below:



Table 7-1: Sector-wise CO<sub>2</sub> Emissions and Interventions Required

Sector	Estimated CO <sub>2</sub> emissions (in mtpa)		Rationale for CCUS	Key interventions required
	2020	2030		
Thermal power generation	1,004	1,210	Even with RE growth, coal-based power will continue to meet more than 50% of electricity demand. As the largest emitter of CO <sub>2</sub> , CCUS in the power sector is essential for meaningful decarbonization and ensuring energy security in India	Establish CCUS clusters in key identified districts
Steel	240	450	Future steel growth is largely based on the BF-BOF route, where the use of fossil fuels is hard to replace. CCUS is necessary for sustainability and also ensures export competitiveness	Establish CCUS for Integrated Steel Plants, particularly in Eastern India
Cement	196	325	Another major CO <sub>2</sub> emitting sector, where fossil fuels are difficult to replace. Utilization of CO <sub>2</sub> in aggregates has synergies with the cement business	Establish CCUS clusters in key identified areas/ districts
Oil & gas upstream, refineries & chemicals	125	177	Hard to abate sector. CCUS essential for the sustainability of the sector; carbon capture inbuilt in many of the processes	Decarbonize key applications like urea, olefins, syngas from petcoke
Hydrogen	56	102	Blue hydrogen is key to the hydrogen economy of the future. Carbon capture is unbuilt in the H <sub>2</sub> production process	Establish pathways for CO <sub>2</sub> utilization and storage
Coal gasification	-	27	Sunrise sector - key to materials and energy security of India, based on India's rich endowments	Establish pathways for CO <sub>2</sub> utilization and storage
<b>Total</b>	<b>1,621</b>	<b>2,291</b>		

6. Commercially proven carbon capture technologies: The mature and commercially proven CO<sub>2</sub> capture technologies may be broadly classified into the following types:

- a. **Chemical solvent-based CO<sub>2</sub> capture technologies:** preferred when dealing with gas streams that are lean in CO<sub>2</sub> and have relatively lower pressures, such as flue gases. The cost and availability of steam is also a key factor as regenerating the solvent requires large quantities of steam.
- b. **Physical solvent-based CO<sub>2</sub> capture technologies:** these work well on gas streams with relatively higher CO<sub>2</sub> concentration and pressure.
- c. **Adsorption-based CO<sub>2</sub> capture:** they are suitable for pre-combustion capture, where the gas stream has high pressure and a high CO<sub>2</sub> concentration.
- d. **Cryogenic CO<sub>2</sub> capture:** preferred in cases where the cost of power is low. This technology also provides a unique advantage by generating additional hydrogen without increasing the amount of feedstock (natural gas)/ producing the same quantity of hydrogen with lower natural gas consumption

7. CO<sub>2</sub> utilization: The pathways for utilization of the captured CO<sub>2</sub> are primarily:

- a. **Enhanced Oil Recovery (EOR):** CO<sub>2</sub> for EOR has been successfully carried out for decades to produce low-carbon oil from maturing oil fields in North America and other geographies. CO<sub>2</sub> EOR could also be feasible for maturing Indian oil fields.
  - b. **Green urea:** Urea production from green ammonia can utilize a significant part of captured CO<sub>2</sub>. Renewable energy-based ammonia (green ammonia) can replace conventional ammonia production from LNG if green hydrogen is available at a competitive cost.
  - c. **F&B applications:** CO<sub>2</sub> utilization in F&B applications comprise of carbonated drinks, dry ice, and modified atmosphere packing; however, the scales are quite small compared to the volume of CO<sub>2</sub> generation/emissions.
  - d. Additionally, there are other promising propositions for the utilization of CO<sub>2</sub>. The relatively matured CO<sub>2</sub> utilization pathways are: chemicals (methanol and ethanol), building materials (concrete and aggregates) and polymers
8. Notwithstanding the above-mentioned opportunities for CO<sub>2</sub> utilization, the permanent sequestration or geological storage of CO<sub>2</sub> in saline aquifers and basaltic traps, EOR and Enhanced Coal Bed Methane Recovery (ECBMR) are the only available pathways for CO<sub>2</sub> disposition at scale. The overall CO<sub>2</sub> storage capacity assessment for India (based on theoretical assessments) for the four options is tabulated below.

**Table 7-2: Theoretical CO<sub>2</sub> Storage Capacity in India**

Storage Pathways	Theoretical Storage Capacity (Gt)	Extent of Existing Research
EOR	3.4	Relatively more researched area; technology tested in major carbon capture projects across the globe
ECBMR	3.5-3.7	Requires more dedicated studies and pilot tests for Indian coal beds; no commercial-scale project
Deep Saline Aquifers	291	Offers great CO <sub>2</sub> storage potential; however, limited data available on storage in deep saline aquifers
Basalts	97-315	Studies required for understanding storage mechanisms in basaltic traps
<b>Total</b>	<b>395-614</b>	

9. Existing studies by the British Geological Society and IIT Bombay indicate a large CO<sub>2</sub> storage potential in India; however, further actions need to be supported by the Government of India to make geological storage of CO<sub>2</sub> a reality in India:
- a. Source sink mapping to prioritize the regions and basins most suitable for CO<sub>2</sub> storage in terms of storage capacity and feasibility
  - b. Pore space mapping and characterization of the most promising CO<sub>2</sub> storage regions and basins - geological characterization and exploration for CO<sub>2</sub> storage, similar to the seven Regional Carbon Sequestration Partnerships (RCSPs) funded by the US Department of Energy (US DOE).
  - c. For the prospective regions identified in India, developing the CO<sub>2</sub> storage infrastructure through characterization, validation and commercial scale development.
10. The key to a successful CCUS implementation in India is to enact a policy framework that supports the creation of sustainable and viable markets for CCUS projects. The private sector is unlikely to invest in CCUS unless there are sufficient incentives or unless it can benefit from the sale of CO<sub>2</sub> or gain credits for emissions avoided under carbon pricing regimes.







Based on the review of the prevailing policy mechanisms in different parts of the world, there are two clear policy choices/approaches for India to adopt, i.e. either carbon credits/incentives based policy or carbon tax based policy.

carbon capture costs through financial instruments and future taxes & growth. On the other hand, the effectiveness of a carbon tax based policy is questionable for a developing country like India and may lead to industrial migration and loss of competitiveness.

11. A comparison of the two approaches reveals that a cash and tax credit based policy is more likely to incentivize CCUS adoption in India, by establishing markets for carbon-based products and offsetting

12. The key elements of the proposed carbon credits and incentives based CCUS policy framework for India are tabulated below:

**Table 7-3: Key Elements of a CCUS Policy Framework for India**

Element	Details
 <p><b>Policy path</b></p>	<ul style="list-style-type: none"> <li>- In the near term, CCUS policy should be carbon credits or incentives based, to seed and promote the CCUS sector in India through tax and cash credits</li> <li>- Over time (probably beyond 2050), the policy should transition to carbon taxes, to enable reaching India's net zero goals by 2070</li> <li>- The policy should establish early stage financing and funding mechanisms for CCUS projects</li> </ul>
 <p><b>Hub &amp; cluster business model</b></p>	<ul style="list-style-type: none"> <li>- Regional hub &amp; cluster models need to be established to drive economies of scale</li> <li>- The role of emitters, aggregators, hub operator, disposers and conversion agents needs to be defined</li> <li>- Preferential procurement in Government tenders for low carbon or carbon abated products</li> </ul>
 <p><b>Low carbon products</b></p>	<ul style="list-style-type: none"> <li>- Incentives to foster innovation for low carbon products through schemes like PLI</li> <li>- Distribution of benefits of economic value added created, to communities most affected by environmental and climate change</li> </ul>
 <p><b>Environmental and social justice</b></p>	<ul style="list-style-type: none"> <li>- Protection of communities and jobs, especially in sectors affected by clean energy regulations</li> <li>- Regulated emission levels and allowances for different sectors</li> </ul>
 <p><b>Accounting and regulatory framework</b></p>	<ul style="list-style-type: none"> <li>- Adoption of Life Cycle Analysis (LCA) framework to take into account Scope 2 and Scope 3 emissions and drive effective carbon abatement</li> <li>- Limiting the CO<sub>2</sub> liability and ownership of participants across the CCUS value chain</li> </ul>
 <p><b>Risk mitigation</b></p>	<ul style="list-style-type: none"> <li>- Monitoring, Verification and Accounting (MVA) framework and monitoring for risk management</li> </ul>

13. Financing CCUS projects can be quite challenging in a developing country like India, even with policy support. To support CCUS in India, it is important to fund and support demonstration scale projects. The typical cost structure of potential CCUS

demonstration projects in India for different sectors can be quite different, depending on the source and quality of the gas stream and the extent of CO<sub>2</sub> capture targeted; the same is summarized below.

**Table 7-4: Sector-wise Typical Carbon Capture Capital Charge and Cash Cost**

Industry name	Ref. Plant capacity	CCU capacity (mtpa)	Capital Costs, Rs. crores	Capital Charges (A), Rs./TCO <sub>2</sub>	Cash Cost (B), Rs./TCO <sub>2</sub>	Total Capture Cost (A+B), Rs./TCO <sub>2</sub>
Gasification based production	70 ktpa H <sub>2</sub>	1 mtpa	Rs. 80-100 Crore	90-120	250-300	340-420
NG based SMR for H <sub>2</sub> production	130 ktpa H <sub>2</sub>	0.7 mtpa	Rs. 700-800 Crore	900-1,200	1,150-1,400	2,050-2,600
Cement	2.5 mtpa clinker	2 mtpa	Rs. 1,600 to 1800 Crore	800-1,000	1,050-1,600	1,800-2,600
Iron and Steel	2.0 mtpa BF BOF based ISP	2 mtpa	Rs. 1,600-2,000 Crore	1,000-1,300	1,900-2,300	2,900-3,600
Refinery (CDU & FCC)	5 mtpa crude processing	1 mtpa	Rs. 1,100-1,300 Crore	1,200-1,400	2,700-3,100	3,900-4,500
Coal-based power	800 MW	5 mtpa	Rs. 3,500-4,000 Crore	700-1,000	2,100-2,500	2,800-3,500
<b>Total</b>		<b>11.7 mtpa</b>	<b>Rs. 8,600 - 10,000 Crore</b>			

The financing of CCUS projects at scale can be considered through options:

- a. **Option 1:** CCUS financing through 'Clean Energy Cess' only
- b. **Option 2:** CCUS financing through bond and gross budgetary support

In both options, it is proposed that a "Carbon Capture Finance Corporation (CCFC)" be developed as a financial institution to fund CCUS projects through equity or debt participation, with the objective of supporting and realizing the carbon neutrality goal. The CCFC will be funded by low-cost sovereign or International Green Funds, Carbon Bonds or Climate Funds. By investing in CCUS projects, along with a part of the incremental tax revenue generated, it should be possible to fund the carbon capture credits, eventually leading to subsidy-neutral CCUS operations.

14. The other measures required for promoting CCUS projects are as follows:
  - a. A statutory body like the 'Bureau of Energy Efficiency (BEE)' is required for the assessment, baselining, and monitoring of CO<sub>2</sub> emissions for each industry.
  - b. PLI for low carbon products should be linked with the decarbonization goal and the

additional cost required for producing green/clean products.

- c. The cost of CO<sub>2</sub> abatement should be subsidized through cash credits (for cash costs) and tax credits (for capital costs). The levels should be commensurate to the industry cost structure and be finalized based on demonstration projects and/or FEED studies. The cash and tax credit mechanism should be reviewed every 3 to 5 years.
  - d. Demonstration projects are essential to find out the best CCUS technologies for different sectors and applications in the Indian context, based on Life Cycle Assessment (LCA) of the CCUS projects. FEED studies, as well as the implementation of demonstration plants should be supported by the Government/PSUs.
15. Promoting CCUS adoption and implementation in India requires a multi-pronged approach to incentivize the following:
    - a. Technology transfer of commercially proven CCUS technologies
    - b. Promoting R&D in novel technologies, particularly in the area of CO<sub>2</sub> utilization
    - c. Encouraging private sector participation in implementing CCUS demo projects

# Bibliography

1. International Energy Agency, IEA
2. Intergovernmental Panel on Climate Change (IPCC)
3. India's Intended Nationally Determined Contributions. (2015). (Retrieved from <https://moef.gov.in/wp-content/uploads/2018/04/revised-PPT-Press-Conference-INDC-v5.pdf>)
4. MIT database - <https://sequestration.mit.edu/tools/projects/index.html>
5. IEA 2009 Roadmap for CCUS
6. Vishal, Vikram, et al. "Understanding initial opportunities and key challenges for CCUS deployment in India at scale." *Resources, Conservation and Recycling* 175 (2021): 105829.
7. Medlock, III, Kenneth B. and Keily Miller, "Expanding Carbon Capture in Texas", Baker Institute Center for Energy Studies, January 2021.
8. IBEF Power, 2021
9. Ministry of Power Annual Report, 2020-2021
10. India Energy Outlook 2021, IEA.
11. Central Electricity Authority (CEA)
12. Power Sector at a Glance (All India) - Ministry of Power
13. Breeze, Paul. *Power generation technologies*. Newnes, 2019.
14. Colin, A. S., Minh, T. H., & Dianne, E. W. (2016). Membrane-Cryogenic Post-Combustion Carbon Capture of Flue Gases from NGCC. *Technologies*, 4(2), 14.
15. Tim, B. & Kashish, S. (2019). Gujarat's Electricity Sector Transformation. IEEFA.
16. Joint Plant Committee (JPC)
17. National Steel Policy, Ministry of Steel
18. IBEF Cement, 2021
19. Indian Minerals Yearbook 2019, Indian Bureau of Mines, Government of India.
20. Cement Manufacturing Association
21. India's Hydrocarbon Outlook, 2020.
22. NETL, US Department of Energy (DOE).
23. IEAGHG 2018 Report on "The Carbon Capture Project at Air Products' Port Arthur Hydrogen Production Facility".

24. UOP White Paper (UOP Polybed™ PSA Systems)

---

25. Air Liquide Technology Handbook 2018.

---

26. Global Status of CCS 2020 Report, Global CCS Institute.

---

27. <https://www.frontiersin.org/articles/10.3389/fmars.2019.00029/full>

---

28. Behera, Bunushree, Nazimdhine Aly, and P. Balasubramanian. "Biophysical model and techno-economic assessment of carbon sequestration by microalgal ponds in Indian coal based power plants." *Journal of Cleaner Production* 221 (2019): 587-597.

---

29. <https://www.energy.gov/fecm/science-innovation/oil-gas-research/enhanced-oil-recovery>

---

30. Mazzotti, M., Pini, R., & Storti, G. (2009). Enhanced coalbed methane recovery. *Journal of Supercritical Fluids*, 47(3), 619-627.

---

31. Vikram, V., Yashvardhan, V., Debanjan, C., & Dhananjayan, A. (2021). A systematic capacity assessment and classification of geologic CO<sub>2</sub> storage systems in India. *International Journal of Greenhouse Gas Control*, 111, 103458.

---

32. Snæbjörnsdóttir, S. e. (2014). CO<sub>2</sub> storage potential of basaltic rocks in Iceland and the oceanic ridges. *Energy Procedia*, 63, 4585-4600

---

33. McGrail, B. P. (2006). Potential for carbon dioxide sequestration in flood basalts. *Journal of Geophysical Research: Solid Earth*, 111(B12).

---

34. A regional assessment of the potential for CO<sub>2</sub> storage in the Indian subcontinent - IEAGHG 2008

---

35. Best Practices for Monitoring, Verification, and Accounting of CO<sub>2</sub> Stored in Deep Geologic Formations (US DOE NETL).

---

36. European Commission- Carbon Capture, Utilization and Storage ([https://energy.ec.europa.eu/topics/oil-gas-and-coal/carbon-capture-storage-and-utilisation\\_en#carbon-capture-storage-and-utilisation-in-the-eu](https://energy.ec.europa.eu/topics/oil-gas-and-coal/carbon-capture-storage-and-utilisation_en#carbon-capture-storage-and-utilisation-in-the-eu))

---

37. Carbon pollution pricing scheme across Canada (<https://www.canada.ca/en/environment-climate-change/services/climate-change/pricing-pollution-how-it-will-work.html>)

---

38. Cost of capturing CO<sub>2</sub> from Industrial sources (DOE/NETL-2013/1602).

---

39. Integrated Environmental Control Model (IECM) Version 11.5.

---

40. IEA Technical Report.

---

41. Climate Bonds Initiative ([www.climatebonds.net](http://www.climatebonds.net) )

---

42. Climate Investment Funds ([www.climateinvestmentfunds.org](http://www.climateinvestmentfunds.org))

---

43. Asian Development Bank ([adb.org](http://adb.org))











सत्यमेव जयते

**NITI Aayog**

[www.niti.gov.in](http://www.niti.gov.in)